



杰 · 曼 · 科 · 技

GMC-X802

User manual

110612120003

V01.00.00

Shenzhen General Measure Technology Co., LTD. All rights reserved.

Without the permission of Shenzhen General Measure Technology Co., LTD., no unit or individual may copy, transmit, transcribe or translate into other language versions in any form or by any means.



Warnings

The product is powered by **DC24V power** supply, misuse of **AC220V power** supply will permanently damage the instrument.

Keep the instrument well grounded.

The product is an electrostatic sensitive device. Take ESD measures during use and maintenance

Standards & Certification

Product standard: **GB/T 7724-2008**
Verification Regulation: **JJG 669-2016**

Contents

Chapter 1 Overview.....	1
1.1 Functions and features.....	1
1.2 Technical Specifications.....	2
1.3 Front Panel instructions.....	3
1.4 Side Panel.....	5
Chapter 2: Installation and wiring.....	6
2.1 Power Connection.....	6
2.2 Loadcell Connection.....	6
2.3 The connection of the IO port.....	8
2.4 Serial port connection.....	9
2.5 Network Port Connection (Optional).....	10
2.5.1 Troubleshooting Network port faults.....	11
2.6 Vibrator Analog Port Connection (Optional).....	11
Chapter 2: Menu Overview.....	13
3.1 Menu.....	13
3.2 Parameter Selection.....	14
3.3 Parameter Settings.....	14
3.4 Character comparison table.....	15
Chapter 3: Weight calibration (1 CAL).....	16
4.1 Calibration parameters.....	16
4.2 Zero calibration.....	17
4.3 Gain calibration.....	17
Chapter 5: TEST (2 TEST).....	19
5.1 Test Parameters.....	19
5.2 IO test.....	19
5.3 IO module factory default value.....	21
5.4 IO definition method.....	22
5.5 The IO definition mapping table.....	23
Chapter 6: Serial port 1 set (3 COM_1).....	33
6.1 Serial Port 1 Set parameters.....	33
Chapter 7: Serial 2 Settings (4 COM_2).....	34
7.1 Serial Port 2 Set parameters.....	34
Chapter 8: Network Port Settings (5 NET).....	35
8.1 Network Port Setup parameters.....	35

Chapter 9: Custom Read/write (6 RW_DT)	36
9.1 Customize Read/write parameters	36
9.2 Customize Read and write parameter Settings	36
Chapter 10: System Parameters (7 SYS).....	39
10.1 System Parameters.....	39
10.2 USB flash drive function	40
Chapter 11: Supporting HMI description	42
Chapter 12: Communication protocol	43
Chapter 13: Procedure Description.....	44
13.1 Timing Diagram.....	44
13.2 Flow Chart	44
Chapter 14: Feeding mechanism	46
Chapter15: Discharge mechanism	49
Chapter 16: Discharge interlock function.....	56
16.1 Standard mode	56
16.2 Single hopper independent mode.....	56
16.3 Multi-channel combination mode.....	57
Chapter17: Error and alarm information	59
Chapter 18: Instrument size (mm)	60

Chapter 1 Overview

1.1 Functions and features

GMC-x802 weighing and packing controller is a weighing control module developed for the fixed-weight packing system of vibrator feeding. It has the function of A and B scales simultaneously packaging and automatically correcting the internal parameters of the module, greatly improving the packaging rate and realizing the intelligence of the system. Rail installation, saving space; Stainless steel shell, strong anti-interference. The new algorithm makes the weighing and control faster and more accurate; It can be widely used in feed, chemical, grain and other industries that need fixed-weight packaging equipment.

Shell type	DIN rail mounting (national standard: 35mm rail), stainless steel housing	
Display	Double row 12-bit display nixie tube	
Language	Chinese and English are supported	
Interfaces	Loadcell interface	Support 2 way 6 -wire analog loadcell weighing platform interface, single connection up to 8 350Ω loadcells
	IO interface	10 in 20 out transistor input/output interface (where PW1-PW6 is PWM output)
	Communication interface	2 RS485 communication ports
	Analog port (optional)	①channel vibrator analog output (current/voltage optional)
		②2 channel vibrators analog output (current/voltage optional)
		③4 channel vibrators analog output (optional current/voltage)
USB port	Support parameters import, export and upgrade by USB	
Network Port (Optional)	① Single network port, supporting TCP-IP	

		communication
		② Dual network port, built-in switch, easy to cascade

1.2 Technical Specifications

Power supply	DC24V±5%
Operating temperature	-10 ~ 40°C
Maximum humidity	90%R.H non-condensation
Power Consumption	About 5W
Physical size	61mm*132mm*126mm
Loadcell power supply	DC5V 125mA (MAX)
Input impedance	10 m Ω
Input sensitivity	0.1 uV/d
Input range	0.02 ~ 8mV (2mV/V loadcell)
Conversion method	Sigma - Delta
Nonlinear	0.01% F.S
Gain drift	10PPM/°C
Maximum display accuracy	1/100000
Keys	6-key sounding keyboard

1.3 Front Panel instructions

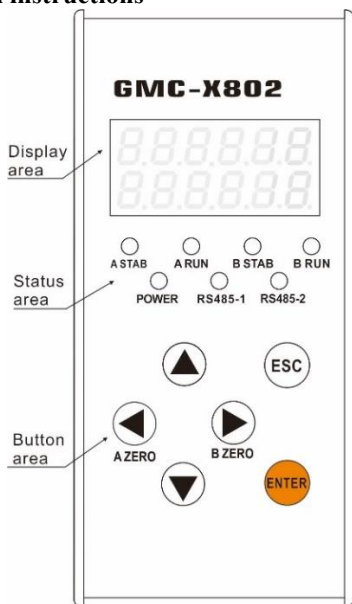

X802 Front panel

Display area: 12 bits, used to display weighing data and instrument related information data







Status indicator:

- **A STAB:** Stability indicator light, when the weight of A scale changes within the stability range, the indicator lights up.
- **A RUN:** Run indicator light, when the scale A is running, the indicator lights up.
- **B STAB:** Stability indicator light. When the weight of scale B changes within the stability range, the indicator lights up.
- **B RUN:** Run indicator light, when the scale B is running, the indicator lights up.
- **POWER:** Power indicator light, when the instrument is powered on, the indicator lights up
- **RS485-1:** Communication indicator light. When RS485-1 is connected successfully, the indicator blinks during data communication.
- **RS485-2:** Communication indicator light. When RS485-2 is

connected successfully, the indicator blinks during data communication.

Key description:

GMC-x802 has a total of 6 key functions, the key functions are as shown below:

Buttons	Operating interface	Key function
	Home interface	/
	Menu interface	Sibling menu goes to the
	Option Class	Toggle options
	Input Class	Selected bit increment
	Home interface	/
	Menu interface	Sibling menu goes to next
	Option Class	Toggle options
	Input Class	Selected bit reduction
 AZERO	Home Screen	A Scale zero
	Menu interface	/
	Option class	/
	Input class	Selected bit move to the left
 BZERO	Home Screen	B Scale zero
	Menu interface	/
	Option Class	/
	Input Class	Selected bit move to the right
	Home Screen	Clear Alarms
	Menu interface	Back to previous menu
	Option Class	Exit modification
	Input Class	Exit modification
	Home Screen	Go to Menu
	Menu interface	Go to the previous menu
	Option Class	Confirm change
	Input Class	Confirm change

1.4 Side Panel

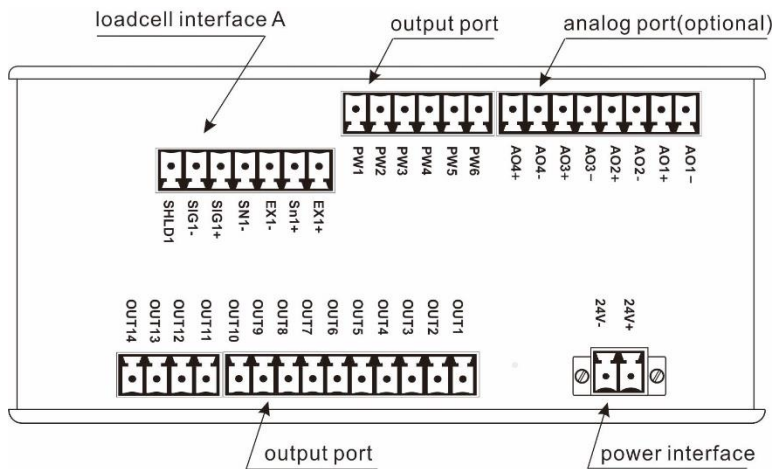

GMC-X802 Side panel Figure 1

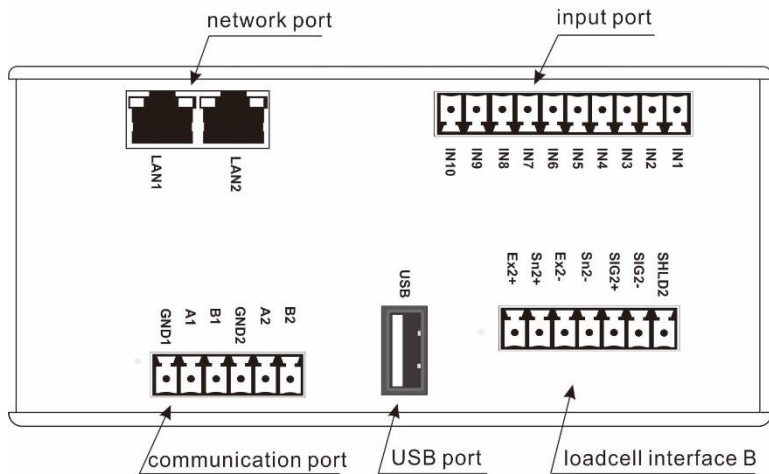

GMC-X802 Side panel Figure 2

Chapter 2: Installation and wiring

2.1 Power Connection

The GMC-X802 packing controller uses a DC 24V power supply. The correct wiring of the power terminal is shown below:



※ PLEASE PAY ATTENTION TO THE POSITIVE AND NEGATIVE POLARITY OF THE POWER SUPPLY, DO NOT CONNECT THE REVERSE.

2.2 Loadcell Connection

The GMC-X802 packaging controller has two loadcell input interfaces, and an external resistance strain bridge loadcell is required. When a **four-wire loadcell is selected, SNn+ and EXn+ of the module must be short-circuited, and SNn- and Exn-** must be short-circuited.

Each port of the loadcell connection terminal is assigned as: (Note: **n=1/2**)

Ports	EXn+	SNn+	EXn-	SNn-	SIGN+	SIGN-	SHLD
6-wire	Power positive	Sensitive positive	Power negative	Sensitive negative	Signal positive	Signal negative	Shielded wire
4-wire	Power positive		Power negative		Signal positive	Signal negative	Shielded wire

Six-wire connection(using Loadcell 1 as an example):

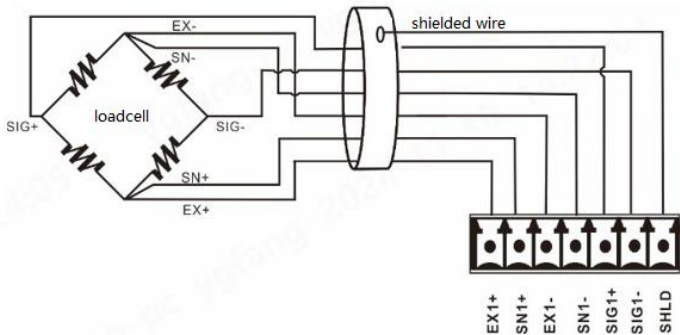

Four-wire connection (using loadcell 1 as an example) :

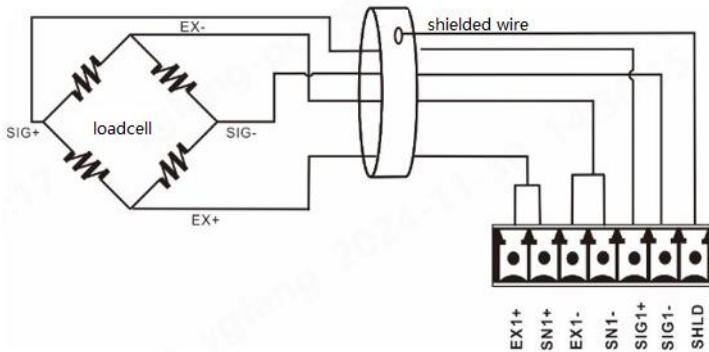

Precautions:

1) Because the output signal of the loadcell is an analog signal that is more sensitive to electronic noise, the loadcell wiring should be shielded cables, and be laid separately from other cables, especially away from AC power;

2) The four-wire loadcell can be selected for the occasions where the transmission distance is short and the temperature change is not large or the accuracy requirements are not high; However, for applications with long transmission distance or high accuracy requirements, six-wire

loadcell should be selected;

3) For multi-loadcell parallel applications, it is necessary to ensure that the sensitivity of each loadcell (**mV/V**) is consistent.

2.3 The connection of the IO port

The GMC-X802 packaging controller includes a 10-bit input and 20-bit output interface. Adopt photoelectric isolation mode, the instrument internal power drive. The input is effective at low level, and the output takes the transistor collector open output mode. Each drive current can reach **200mA**, full load current is up to 4A. Among them, **PW1~PW6** is PWM output port, which can output high-speed pulse signal for controlling servo motor, wiring method and other aspects are the same as ordinary output port. The terminal wiring is shown in the following figure:

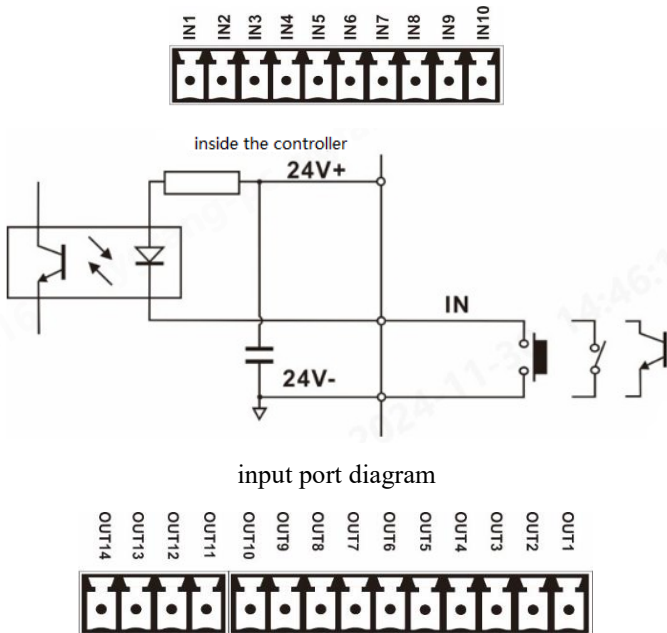

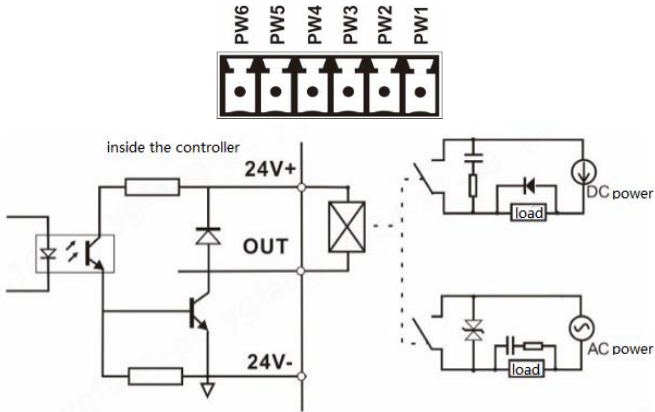

IO output interface diagram

When the product leaves the factory, the input and output port make the initial function definition, when the initial definition value can not meet the production demand is, which can cutstomly define the input and output function.

For the list of initial values and defined functions, refer to [Chapter 5.3 Factory Default Values of IO modules.](#)

2.4 Serial port connection

GMC-X802 provides two RS485 serial communication interfaces, and the serial port supports MODBUS (RTU/ASCII) protocol, continuous transmission and result transmission protocol.

The interface is shown in the following picture:

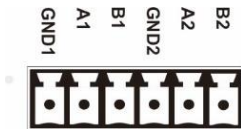

RS485 connection mode:

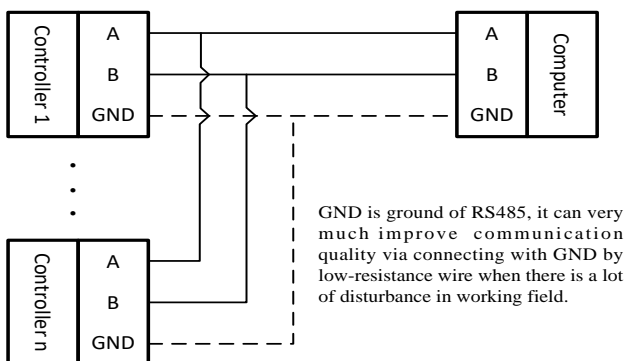

2.4.1 Troubleshooting the Serial port

If the serial port communication fails, check:

- Check the cable connection according to the above connection method; Make sure the connection is correct.

The RS485 port must be connected to wires A and B.

- Ensure that the parameters of the connection port are consistent with those of the host.

Slave number, baud rate, data format and communication protocol must be consistent with the host computer and **PLC**.

2.5 Network Port Connection (Optional)

The product supports single/dual network port communication and supports Modbus TCP network port protocol. Dual network port option, network port built-in switch, easy to cascade. For details about how to set network port parameters, see [Chapter 8 Setting Network Port \(NET\)](#).

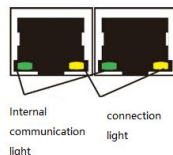

Internal communication light: If the hardware connection is normal, the internal communication light of the instrument will be steady on.

Connection light: The network cable is connected properly and the

connection light is blinking.

2.5.1 Troubleshooting Network port faults

If the network port communicate fails, check:

- Check network port indicators.

If the hardware connection is normal, the internal indicator of the instrument will be steady on.

If the network cable is connected properly, the connection indicator will blink.

- Check whether the communication protocol is consistent with that of the host computer and PLC.
- Confirm that the instrument can be pinged from the network. If not, check the hardware interface section.
- Check whether IP conflicts exist.
- Restart the instrument.

2.6 Vibrator Analog Port Connection (Optional)

The GMC-X802 can be configured with 1, 2 and 4 channel analog output functions. Voltage and current optional, support 0~5V, 0~10V, 0~24mA, 4~20mA.

1) Optional: **1** analog output:

AO1+ : A scale small vibrator analog output positive end

AO1- : A scale small vibrator analog output negative end

N/A: empty connection

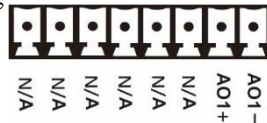

2) Optional: **2** analog output:

AO1+ : A scale small vibrator analog output positive end

AO1- : A scale small vibrator analog output negative end

AO3+ : B scale small vibrator analog output positive end

AO3- : B scale small vibrator

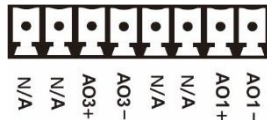

analog output negative end

N/A: empty connection

3) Optional: 4 analog output:

AO1+ : A scale small vibrator

analog output positive end

AO1- : A scale small vibrator

analog output negative end

AO2+ : A scale large vibrator analog output positive end

AO2- : A scale large vibrator analog output negative end

AO3+ : B scale small vibrator analog output positive end

AO3- : B scale small vibrator analog output negative end

AO4+ : B scale large vibrator analog output negative end

AO4- : B scale large vibrator analog output negative end

N/A: empty connection

Vibrator connection of the scale platform:

1) Double vibrators:

A scale double vibrator (optional 4 analog function) : AO2+ and AO2- connect the fast feeding vibrator; AO1+ and AO1- connect the slow feeding vibrator.

B scale double vibrator (optional 4-channel analog function) : AO4+ and AO4- connect fast feeding vibrator; AO3+ and AO3- connect the slow feeding vibrator.

2) Single vibrator: Since the single vibrator feed is not divided into fast feeding vibrator and slow feeding vibrator, the vibrator driver can be connected to any of the two sets of analog output.

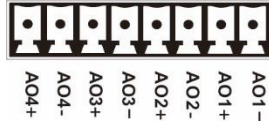

Chapter 2: Menu Overview

3.1 Menu

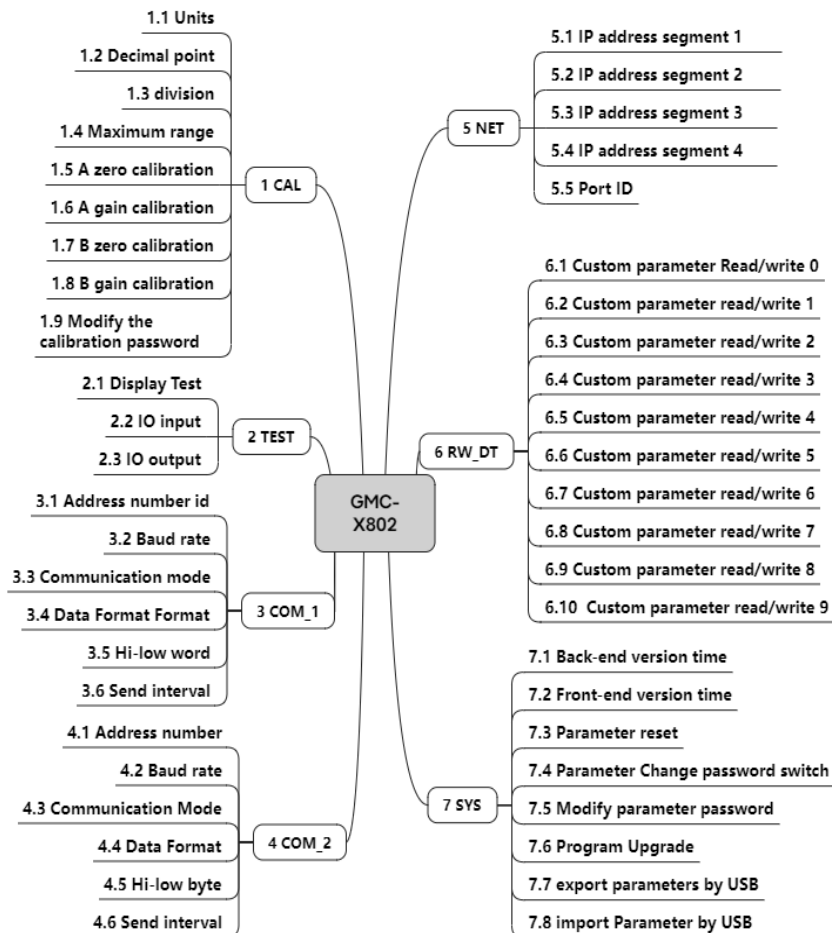

3.2 Parameter Selection

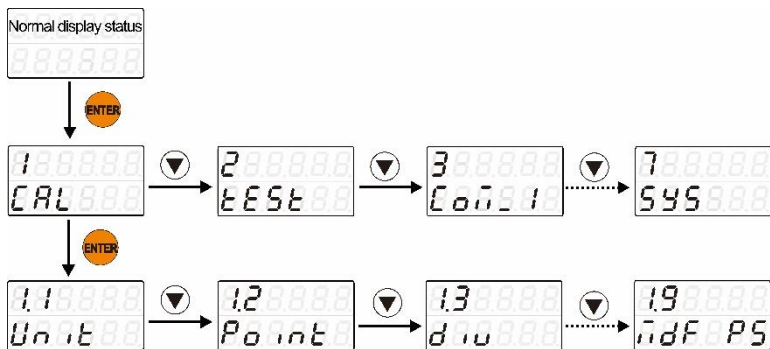

1). Press Keys \blacktriangledown \blacktriangle to select the required items before the same level, taking 1 CAL standard parameter as an example, that is, when 1.1 unit is displayed, Press the key \blacktriangledown can be switched to 1.2 point, and press the key \blacktriangle can be switched to 1.9 mdf ps.

2). Press the key **ENTER** to enter the small item under the current big item, that is, when displaying 1 CAL, press this key to enter 1.1 unit, you can modify the relevant parameters. Press **ESC** to exit the current parameter.

3.3 Parameter Settings

1) Option class (switching units from kg to g as an example) :

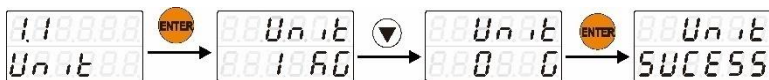

2) Value class (adjust the serial port sending interval from 5ms to 15ms)

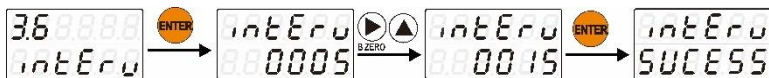

3.4 Character comparison table



The instrument is displayed in a two-line 12-bit digital tube, and the displayed English characters correspond to the following (case insensitive) :



a	b	c	d	e	f	g	h	i	j	k	l	m
A	b	C	d	E	F	G	H	,	J	K	L	m
n	o	p	q	r	s	t	u	v	w	x	y	z
n	o	P	q	r	S	t	U	v	w	x	y	z

Chapter 3: Weight calibration (1 CAL)

When the product is used for the first time or any part of the weighing system changes and the current device calibration parameters cannot meet the user's requirements, the controller should be calibrated. The calibration can determine the unit, decimal number, system zero, gain and so on of the weighing system.





4.1 Calibration parameters

No.	Parameters	Initial value	Instructions
1.1	Units	kg	Range: t, kg, g, lb
1.2	Decimal point	0	Range: 0, 0.0, 0.00, 0.000, 0.0000
1.3	division (div)	1	Minimum change in weight value Range: 1, 2, 5, 10, 20, 50, 100, 200, 500
1.4	Maximum range (Cap)	10000	Range \leq division * 100000; When the weight value > the maximum range +9d(division), the module output overflow mark (modify the division causes the maximum range to be out of range, the system automatically adjusts the maximum range value to ensure the requirements of the maximum range).
1.5	A zero calibration (A-Zero)	/	Empty the weighing platform, display zero millivolts, press the button  to perform zero calibration for scale A.
1.6	A gain calibration (A-load)	/	Load the weight to scale A, display the relative millivolts after loading the weight, press  key, prompt "SUCESS", that is, complete the gain calibration.
1.7	B zero calibration	/	Empty the weighing platform, display zero millivolts, press the

	(b-Zero)		button  to perform zero calibration for scale B.
1.8	B gain calibration (b-load)	/	Load the weight to scale B , display the gain millivolts after loading the weight, press  key, prompt "SUCESS", that is, complete the gain calibration.
1.9	Modify the calibration password (mdf ps)	000000	Modify the calibration password to be 6 bits.

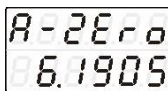
4.2 Zero calibration

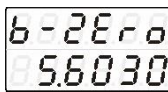
The instrument is calibrated, the zero point calibration should be performed first, and the zero point calibration operation should be performed on the scale A and B respectively.

	<p>A scale zero calibration interface: empty the scale platform, when the scale platform is stable, press the button  to display the current millivolt, and then press the button  to display "SUCESS" to complete the zero calibration.</p>
	<p>B Scale zero calibration interface: empty the scale platform, after the scale platform is stable, press the button  to display the current millivolt, and then press the button  to display "SUCESS" to complete the zero calibration.</p>

4.3 Gain calibration

After the zero point calibration is completed, load the weight to the scale platform. After the scale platform is stable, enter the weight value of the weight to complete the gain calibration. The operation instructions are as follows:

A scale gain calibration:

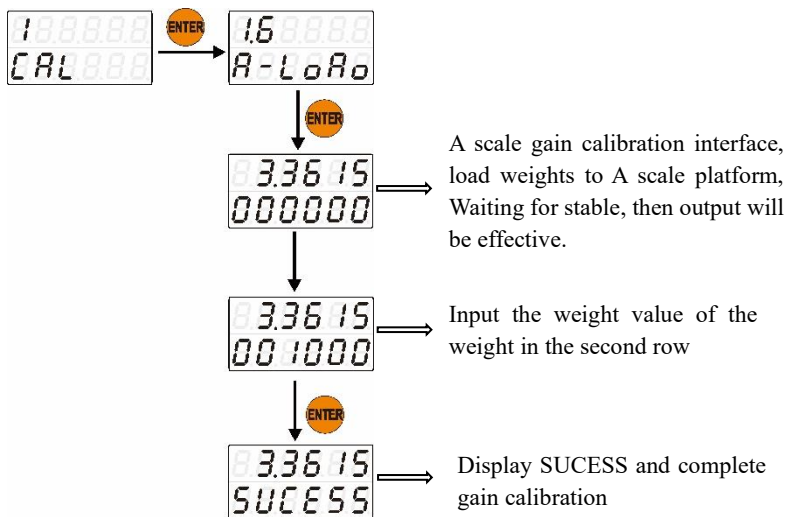



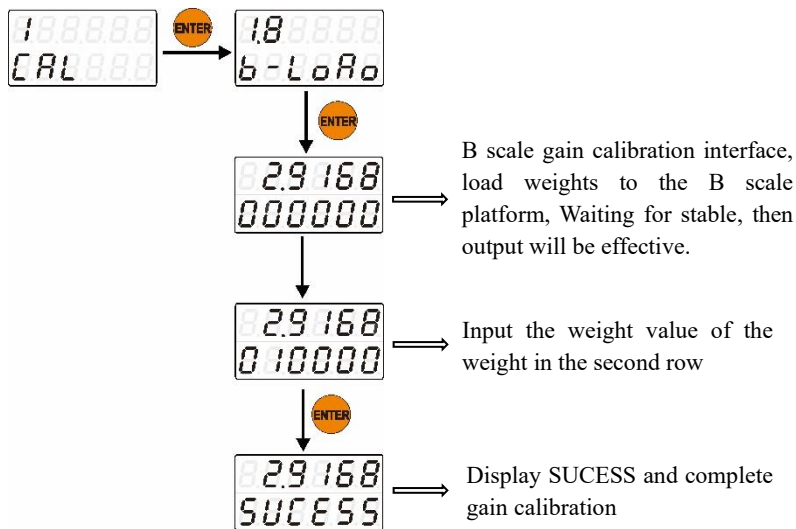



B scale gain calibration:



Chapter 5: TEST (2 TEST)

5.1 Test Parameters

No.	Parameters	Initial values	Instructions
2.1	Display Test (display)	/	After inputting, the nixie tube and LED lights are all on, all off after pressing the button  , and press the button  , all on again.
2.2	IO input (io in)	/	  Any key toggles the first row of IO input bits
2.3	IO output (io out)	/	  Any key toggles the first row of IO output bits

5.2 IO test

The IO test is used to test whether the connection between the input and output interfaces of the instrument and the peripherals is normal. Whether the instrument can accept the external input signal, and whether the external device can receive the output signal of the instrument.

Input test:

1) Write "1" to the address 08300 (PLC address 408301) to enter the IO test mode, when the input port is valid (can be achieved by short-connecting the GND port and the input signal port), the corresponding input port address 8301~8310(PLC address 48302~48311) register value should be "1", When the input becomes invalid, the data read out should be "0", otherwise it indicates that the input port is faulty.

2) Interface operation instructions:

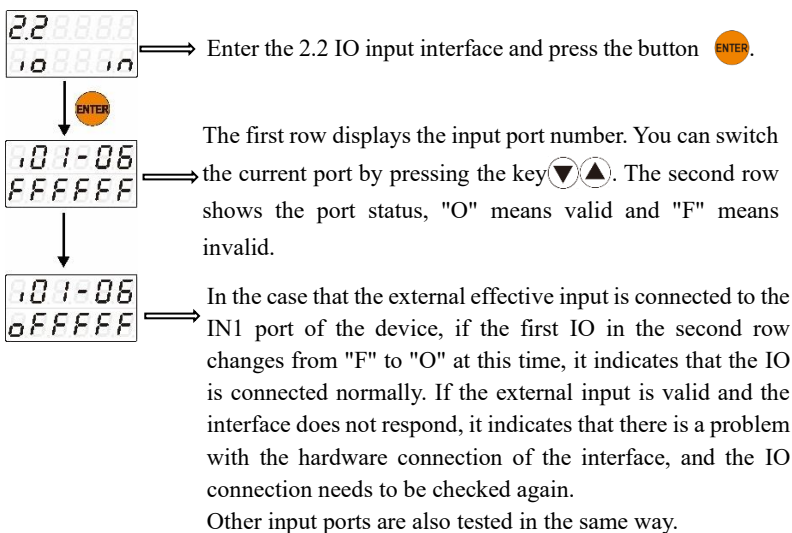

Output test:

1) Write "1" into address 8300 (PLC address 48301) to enter IO test mode, write "1" into address 8350~8369(PLC address 48351~48370) corresponding to the output port, measure the voltage between the port and 24V+. If the voltage is much less than 24V, it indicates that the effective state of the output is abnormal, if the voltage is equal to or close to 24V, it indicates that the effective state is normal. Then write "0" to the corresponding address of the port, set the port as invalid, high resistance state, the voltage is no longer 24V, it means that the output invalid state of the port is normal. Both valid and invalid are normal, indicating that the output port works normally.

2) Interface operation instructions:

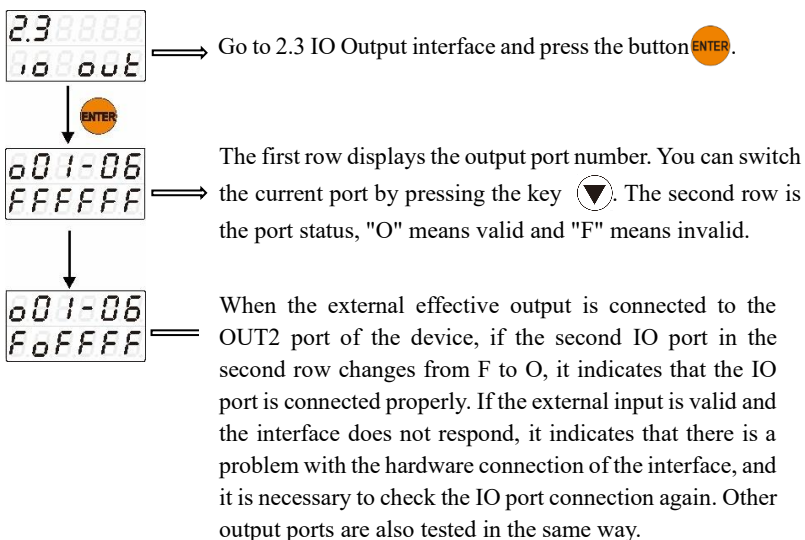

5.3 IO module factory default value

Input port default definition value:

Input port	Define values	Function code	Defined Values
IN 1	Run(Total)	IN 6	Clear alarm(Total)
IN 2	E-Stop(Total)	IN 7	A scale discharge gate closed in place
IN 3	Discharge allowed (Total)	IN 8	B Scale discharge gate closed in place
IN 4	slave 1 Discharge request (Total)	IN 9	A scale discharge gate open in place
IN 5	slave discharge state(Total)	IN 10	B Scale discharge gate open in place

Output port default definition:

Input Port	Define values	Function code	Defined Values
OUT 1	Run(Total)	OUT 11	Over/Under(A)
OUT 2	Stop(Total)	OUT 12	Over/Under(B)
OUT 3	Weigh OK(Total)	OUT 13	Dscharge gate open(A)
OUT 4	Discharge status(Total)	OUT 14	Discharge gate open(B)
OUT 5	Fast Feed(A)	PW1	discharge gate closed(A)
OUT 6	Fast Feed(B)	PW2	discharge gate closed(B)
OUT 7	Mid Feed(A)	PW3	discharge status(A)
OUT 8	Mid Feed(B)	PW4	discharge status(B)
OUT 9	Slow Feed(A)	PW5	feed/discharge timeout(A)
OUT 10	Slow Feed(B)	PW6	feed/discharge timeout(B)

5.4 IO definition method

When the factory definition functions of the IO input and output do not meet the actual production needs, the IO input and output functions can be redefined to meet the production needs to the greatest extent.

Define the address range: 0400~0459 (PLC address: 40401~40460).

Definition method: Write the required function number in the address corresponding to the IO to complete the definition. If the IO input port IN2 is defined as the "switch formula(total)" function, it is

necessary to write "10" to the address 0402-0403(PLC address 40403~40404). After writing successfully, the external IN2 input is valid, and the module executes the switching formula.

5.5 The IO definition mapping table

The input port defines the comparison table:

Function number	Function name	Define content
0	undefined	No function
1	Run(Total)	When the input is valid (two scales/A scale/B scale) enter the feeding process, or enter the running state
2	Stop(Total)	After completing the feeding process, discharging process and loosening bag process, turn to stop
3	E-Stop(Total)	Stop immediately when the input is valid
4	discharge allowed(Total)	When the input is valid, it means that the external condition have been met and the material can be discharged. The single hopper independent mode only control the A scale
5	slave discharge request(Total)	When the master is in charge, the input effectively indicates that the slave 1 has completed feeding and setting, waiting for the host to give a signal allowing discharge
6	slave discharge status(Total)	When the master is in control, this input effectively indicates that the slave is discharging
7	empty material (Total)	Start emptying material when the input is valid, and give the stop or emergency stop signal to stop empty material

8	simulation test(Total)	Run the entire process according to time, regardless of weight, as long as it is used for equipment action testing
9	clear alarm(Total)	When the input is valid, clear all current alarms
10	switch recipe(Total)	Switch to the next recipe with the target value when the input is valid
11	Zero(A)	Zero when A scale input is valid
12	Zero(B)	zero when B scale input is valid
13	run(A)	Start feeding when the A scale input is valid
14	run(B)	Start feeding when the B scale input is valid
15	stop(A)	When the input of A scale is valid, it will be stopped after completing this feeding and discharging
16	stop(B)	When the input of B scale is valid, it will be stopped after completing this feeding and discharging
17	E-Stop(A)	Stop immediately when the A scale input is valid
18	E-stop(B)	Stop immediately when the B scale input is valid
19	discharge gate closed in place(A)	A When the A scale input is valid, the discharge gate is closed and in place
20	discharge gate closed in place(B)	When the B scale input is valid, the discharge gate is closed and in place
21	discharge gate open in place(A)	A scale motor positive and negative mode (dual photoelectric), the discharge gate open in place effective
22	discharge gate open in place(B)	B scale motor positive and negative rotation mode (dual

		photoelectric), discharge gate open in place effective
23	manual fast feed(A)	In the stop state of A scale, open the manual fast feeding when the input is valid, stop or emergency stop signal will stop feeding
24	manual fast feed(B)	In the stop state of B scale, open the manual fast feeding when the input is valid, stop or emergency stop signal will stop feeding
25	manual mid feed(A)	In the stop state of A scale, open manual feeding when the input is valid, stop or emergency stop signal will stop feeding
26	manual mid feed(B)	In the stop state of B scale, open manual feeding when the input is valid, and stop or emergency stop signal to stop feeding
27	manual slow feed(A)	In the stop state of A scale, open manual slow feeding when the input is valid, stop or emergency stop signal to stop feeding
28	manual slow feed(B)	In the stop state of B scale, open manual slow feeding when the input is valid, and stop or emergency stop signal to stop feeding
29	Manual discharge (A)	In the stop state of A scale, when the input is valid, perform a complete discharge process
30	Manual discharge(B)	In the stop state of B scale, when the input is valid, perform a complete discharge process
31	single run(A)	In the stop state of B scale, while the input is valid, perform a complete feeding action
32	single run(B)	In the stop state of B scale, when

		the input is valid, perform a complete feeding action
33	simulation test(A)	A scale runs the entire process according to time, regardless of weight, as long as it is used for equipment action testing
34	simulation test(B)	B scale runs the entire process according to time, regardless of weight, as long as it is used for equipment action testing
35	empty material(A)	When the input of A scale is valid, start emptying material, and give the stop or emergency stop signal to stop emptying material
36	Empty material(B)	When the input of B scale is valid, start emptying material and give the stop or emergency stop signal to stop cleaning
37	Clear alarm(A)	When the A scale input is valid, clear all current alarms
38	Clear alarm(B)	When the B scale input is valid, clear all current alarms
39	clip/loose bag(Total)	Perform Clip/loose bag action when the input is valid, if the working mode is single hopper independent, then only control the A scale
40	slave 2 discharge request(Total)(valid in host mode)	When the master is in control, the input effectively indicates that the slave 2 has completed feeding and setting, waiting for the host to give a signal to allow discharge signal
41	Upper level	The upper level device used to connect the material hopper. When the upper level input is valid, the material hopper is full.
42	Lower level	The lower level device used to

		connect the material hopper. The lower level input is invalid or suspended means lack of material. When the lower level input is valid, it indicates that there is no shortage of material.
43	Reserved	Reserved
44	Reserved	Reserved
45	Clip/loose bag(B)	When the input of B scale is valid, perform the clip/loose bag action is allow. The working mode is single hopper independent, it will be valid
46	Allow discharge(B)	When the input of B scale is valid, it indicates that the external conditions have been achieved and the material can be discharged. The working mode is single hopper independent, it will be effective.
47	start sew machine	Start the sewing machine when the input is valid, start the sewing machine start delay
48	E-stop sew machine	The sewing machine stops when the input is valid
49	feed gate closed in place(A)	The output defines the signal as the limit input signal of the A scale feed gate closed in place when the A feed stepper motor pulse output.
50	feed gate closed in place(B)	The output defines when the B feeding stepper motor pulse output, the signal is used as the limit input signal of the B scale feeding gate closed in place.

The output interface definition table:

Function number	Feature name	Define content
0	Undefined	No function
1	Run(Total)	Any scale run is valid
2	Stop(Total)	It only works if both scales A and B are stopped
3	Weigh OK(Total)	Any scale is valid if it has a good signal
4	Slave machine discharge condition(Total)	Any scale is effective in discharging, when the discharging state input from the machine is effective, the discharging state output of the main machine is also effective
5	Run(A)	A scale is effective when running
6	Run(B)	B scale is valid when running
7	Stop(A)	A scale is valid when stopped
8	Stop(B)	B scale is valid when stopped
9	Fast feed(A)	A scale fast extra time is effective
10	Fast feed(B)	B scale fast extra time is effective
11	Mid feed(A)	A scale is valid when mid feed
12	Mid feed(B)	B scale is valid when mid feed
13	Slow feed(A)	A scale slow extra time is effective
14	Slow feed(B)	B scale slow extra time is effective
15	Feed complete(A)	A scale is valid when it completes slow feeding, not when it begins discharging
16	Feed complete(B)	B scale is valid when it completes slow feeding, not when it starts discharging
17	Over/under(A)	A scale has an output when there is

		an over and under error, and the output time is: over and under error alarm pause time
18	Over/under(B)	B scale has the output when there is over and under error, and the output time is: over and under error alarm pause time
19	replenishing material(A)	A scale is valid when replenishing material
20	replenishing material(B)	B scale is valid when replenishing material
21	Weigh OK(A)	A scale is valid after the value is completed
22	Weigh OK(B)	B scale is valid after the value is completed
23	A scale discharge gate open	Control the output of the discharge gate open during discharge
24	B scale discharge gate open	Control the output of the discharge gate open during discharge
25	A scale discharge gate closed	Control the output of the discharge gate when discharging, and it needs to be used only in the positive and negative motor rotation mode
26	B scale discharge gate closed	Control the output of the discharge gate when discharging, and it needs to be used only in the positive and negative motor rotation mode
27	A scale discharge status	It is valid during the discharge process and not valid until the discharge process is complete

28	B scale discharge status	Valid during discharge, invalid until the discharge process is complete
29	A feed/discharge timeout	feeding/discharging timeout stop and output is valid
30	B feed/discharge timeout	feeding/discharging timeout stop and output valid
31	Allow slave 1 discharge	Host mode valid
32	discharge request(Total)	Valid when discharge is required, invalid after receiving discharge (connect the host's "discharge request from the machine" port when the slave is connected to the host) (connect the host to the external discharge scale PLC or ready decision device), and indicate A scale when the single hopper independent mode
33	Clip Bag(Total)	Effective when clamping the bag, if the working mode is single hopper independent, only control the A scale
34	Clip Bag(Total)	Effective when coding, if the working mode is single hopper independent, only control the A scale
35	Allow slave 2 discharge	Host mode valid
36	discharge pulse(A)	Discharge stepper motor pulse output (can only be defined on PW1-PW6 PWM port)
37	discharge pulse(B)	Discharge stepper motor pulse output (can only be defined on PW1-PW6 PWM port)
38	Supply material	A feeding mechanism used to control the front end of the packaging scale,

		which is effective when the hopper level input (level input defined) is invalid; this output when the upper level of the material hopper (the upper level input is defined) is valid
39	Lack Material	Lower level input is defined, and the definition port is valid when the input is invalid; When the prep material hopper lower level (the lower level input is defined) is valid, this output is invalid.
40	discharge request(B)	Valid when discharging is required, invalid after receiving discharge signal, valid when working mode is single hopper independent
41	Clip bag(B)	Effective when clipping bag, and effective when the working mode is single hopper independent
42	Coding(B)	Effective when coding, and effective when the working mode is single hopper independent
43	Sew machine	After the start-up delay of the sewing machine reached, the output effective time is the output time of the sewing machine.
44	Cutter	The output is valid after the end of the starting delay of the cutting machine, and the effective time is the output time of the cutting machine
45	Custom feed 1(A)	Output according to fast-feed custom and mid-feed custom
46	Custom feed 2(A)	Output according to fast-feed custom and mid-feed custom
47	Custom feed 1(B)	Output according to fast-feed custom and mid-feed custom

48	Custom feed 2(B)	Output according to fast-feed custom and mid-feed custom
49	feed small belt pulse(A)	feed stepper motor pulse output (can only be defined on PW1-PW6 PWM port)
50	Feed large belt pulse(A)	feed stepper motor pulse output (can only be defined on PW1-PW6 PWM port)
51	feed small belt pulse(B)	feed stepper motor pulse output (can only be defined on PW1-PW6 PWM port)
52	Feed large belt pulse(B)	feed stepper motor pulse output (can only be defined on PW1-PW6 PWM port)
53	feed stepper motor pulse output(A)	The signal is used as the pulse signal output to the stepper motor driver of A scale to control the motor rotation. (Can only be defined on PW1-PW6 PWM port)
54	feed stepper motor direction signal(A)	The signal is used as the motor rotation direction signal output to the stepper motor driver of the B scale to control the positive and negative rotation of the motor.
55	feed stepper motor pulse output(B)	The signal is used as the pulse signal output to the stepper motor driver of B scale to control the motor rotation. (Can only be defined on PW1-PW6 PWM port)
56	feed stepper motor direction signal(B)	The signal is used as the motor rotation direction signal output to the stepper motor driver of B scale to control the positive and negative rotation of the motor.

Chapter 6: Serial port 1 set (3 COM_1)

6.1 Serial Port 1 Set parameters

Serial Number	Parameters	Initial values	Instructions
3.1	Address number id	1	Range: 0 to 99.
3.2	Baud rate	38400	Range: 9600, 19200, 38400, 57600, 115200
3.3	Communication mode	Modbus-RTU	Range: Modbus-RTU, Modbus-ASCII, Cont continuous send, result send
3.4	Data Format Format	8-E-1	Range: 8-N-1, 8-E-1, 8-O-1, 7-E-1, 7-O-1 (8-bit data bit, parity check bit, and 1-bit stop bit).
3.5	Hi-low word	AB-CD	Modbus communication display mode Range: AB-CD(high byte in front), CD-AB(low byte in front)
3.6	Send interval (interv)	5	Valid only under Continuous Send protocol The value ranges from 0 to 1000ms

Chapter 7: Serial 2 Settings (4 COM_2)

7.1 Serial Port 2 Set parameters

Serial Number	Parameters	Initial values	Instructions
4.1	Address number (id)	1	The value ranges from 0 to 99.
4.2	Baud rate(buad)	38400	Range: 9600, 19200, 38400, 57600, 115200
4.3	Communication Mode(mode)	Modbus-RTU	Range: Modbus-RTU, Modbus-ASCII, Cont continuous send, result send
4.4	Data Format (Format)	8-E-1	Range: 8-N-1, 8-E-1, 8-O-1, 7-E-1, 7-O-1 (8-bit data bit - Parity check - 1-bit stop bit).
4.5	Hi-low byte (Hi-low)	AB-CD	Modbus communication display mode: Range: AB-CD(high byte in front), CD-AB(low byte in front)
4.6	Send interval (interv)	5	Valid only under Continuous Send protocol The value ranges from 0 to 1000ms

Chapter 8: Network Port Settings (5 NET)

8.1 Network Port Setup parameters

ID	Parameters	Initial values	Instructions
5.1	IP address segment 1 ip 1	192	Range: 0 to 255
5.2	IP address segment 2 ip 2	168	Range: 0 to 255
5.3	IP address segment 3 ip 3	80	Range: 0 to 255
5.4	IP address segment 4 ip 4	125	Range: 0 to 255
5.5	Port ID	502	Range: 0 to 60,000 Network communication port number setting, 0 indicates that the connection is closed

GMC-X802 can be optional network communication interface, with RJ-45 crystal head connection, to achieve communication with the host computer or PLC.

1) Single network port option, support TCP protocol, LAN1 can do network port communication, LAN2(identification N/A) is not available.

2) Dual network port option (1 group IP), built-in switch, supports up to 4 TCP connections.

3) Using Modbus-TCP communication protocol, the IP address of the network port should be set in the working parameter 5 NET. If the IP address of the network port is 192.168.101.106, then the 5.1 ip_1 input should be 192, 5.2 ip_2 input 168, 5.3 ip_3 input 101, 5.4 ip_4 input 106; The port number is set to 5.5 port.

4) MAC address View range: 10100 to 10111 (PLC address 410101 to 410112).

Chapter 9: Custom Read/write (6 RW_DT)









9.1 Customize read/write parameters

ID	Parameters	Initial values	Instructions
6.1	Custom parameter Read and write 0, rw	40001	Parameter Custom 0
6.2	Custom parameter read/write 1, rw dt1	40001	Parameter Custom 1
6.3	Customize Parameter Read/write 2, rw dt2	40001	Parameter Custom 2
6.4	Customize Parameter Read/write 3, rw dt3	40001	Parameter Custom 3
6.5	Customize Parameter Read/write 4, rw dt4	40001	Parameter Custom 4
6.6	Customize parameter Read/write 5, rw dt5	40001	Parameter Custom 5
6.7	Customize parameter read/write 6, rw dt6	40001	Parameter Custom 6
6.8	Customize Parameter Read/write 7, rw dt7	40001	Parameter Custom 7
6.9	Customize Parameter Read/write 8, rw dt8	40001	Parameter Custom 8
6.10	Custom parameter read/write 9, rw dt9	40001	Parameter Custom 9

9.2 Customize read and write parameter Settings

The instrument has the function of user-defined parameter read and write. If you need to read and write a parameter in emergency, you can use this function. For details about the address area for user-defined parameter read and write, see the MODBUS communication address table in [110612120004 GMC-X802 Standard Communication Manual](#)

The operation method is as follows (6.1 rw dt0 is defined as a digital filter parameter, and the default value is changed to 5 as an example) :

- 1) Query "Digital filter" parameter address is 0122~0123(PLC address 40123~40124), the default value is 4.
- 2) Enter 6.1 Custom parameter read and write 0, press the key , the instrument briefly displays the current custom information, the first row display rw dt0 indicates that the current belongs to the custom read and write 0, the second row display word is (4x single word), because our "digital filter" this parameter is 4x double word, so need to modify the type, at this time press the key , the second row display flashes, Press the button  to modify type: dbword(4x double word), word(4x single word) coils(0x coil), select dbword(4x double word) and press the key  again.
- 3) At this time, the parameter read state is entered, and the first row displays the parameter address, while the second row displays the parameter value.
- 4) If the address is not correct at this time, then long press button  to enter the modify/read/write address, and the button  continues to return to the parameter read state after the modification is completed.
- 5) Modify the parameter value, long press button , enter the parameter value modification state, after the modification is complete, press button  continue to return to the parameter read state.

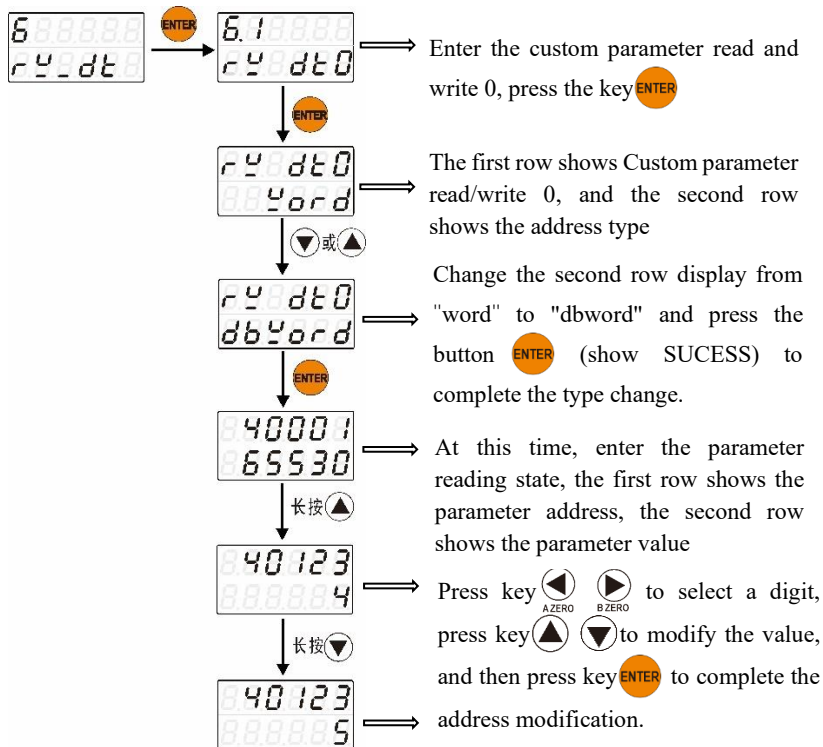

Enter the custom parameter read and write 0, press the key **ENTER**

The first row shows Custom parameter read/write 0, and the second row shows the address type

Change the second row display from "word" to "dbword" and press the button **ENTER** (show SUCESS) to complete the type change.

At this time, enter the parameter reading state, the first row shows the parameter address, the second row shows the parameter value

Press key **◀** **▶** to select a digit, press key **▲** **▼** to modify the value, and then press key **ENTER** to complete the address modification.

Press Key **◀** **▶** to select digit, Press key **▲** **▼** to modify the value, and then press key **ENTER** to complete the parameter value modification

Chapter 10: System Parameters (7 SYS)

10.1 System Parameters



No.	Parameters	Initial values	Instructions
7.1	Back-end version time ver bc	/	View the system back-end version and time, the first row shows the back-end version, and the second row shows the compile date.
7.2	Front-end version time ver dp	/	View the system fore-end version and time, the first row shows the fore-end version and the second row shows the compile date.
7.3	Parameter reset reset	all	Range: all parameter reset, uncalibrated content reset, calibrated parameter reset, application parameter reset (except IO function, other are address table parameters), recipe parameter reset (address table parameters), tran transfer parameter reset, IO function reset Note: Corresponding address 8900-8920(PLC address 48901-48921)
7.4	Parameter Change password switch Ps sw	off	Set parameters Change password switch (on, off) on: To modify parameters, enter the correct password; off: no password is required for parameter modification
7.5	Modify parameter password mdf ps	000000	Change the parameter password, which is 6 characters in length
7.6	Program Upgrade	USB	How to perform program upgrades

	update		
7.7	export parameters by USB Export	all	Range: all export all parameters, export application parameters (in addition to IO function, other address table parameters), export weight parameters, export communication parameters, export io parameters, export transmitter parameters, export recipe parameters (address table parameters). Note: corresponding address 8652-8653(PLC address 48653-48654)
7.8	import Parameter by USB import	all	range: all import all parameters, import application parameters, import weight parameters, import communication parameters, import io parameters, import transmitter parameters, import recipe parameters



10.2 USB flash drive function

Usb flash drive function requirements USB flash drive must meet the following requirements: USB2.0, Fast32 format, capacity is less than or equal to 32G.

Parameter export by USB:

Insert the USB flash drive into the USB port, press  and  to enter the menu 7.7 Parameter USB Export, select the parameter range to be exported, press the button  to confirm the export parameters.

Parameter import by USB:

Insert the USB flash drive into the USB port, press  and  to enter the menu 7.8 Parameter USB Import, select the parameter range to be imported, press the button  to confirm the import parameters.

USB upgrade function:

In order to follow-up product optimization, convenient to upgrade program, provide U disk upgrade function. The specific operations are as follows: Get the upgrade file of GMC_X802CD.gm or GMC_X802C2.gm from our technical department, and put the file in the path of the U disk: GMC_X802CD(C2)// gmc_x802cd(c2).gm. Insert U disk in the instrument, enter the menu 7.6 program upgrade, when the second row flashes usb, press the button  to confirm the start of upgrade, if the file is correct, the instrument will make a drip sound to start the upgrade, wait for a moment to upgrade it. **Pay attention to the upgrade process do not power off! Upgrade file, please call our technical support department to obtain!**

Chapter 11: Supporting HMI description

This instrument comes with key display to set basic parameters for commissioning. In actual work, the touch screen or the upper computer should be used for status monitoring and parameter setting.

Our company provides two scales/four scales/six scales/ten scales universal sample touch screen, contact the technical support department for communication and access.

Chapter 12: Communication protocol

Gmc-x802 provides two serial communication ports, 2 RS485 to achieve communication with the host computer. The serial port supports Modbus **RTU** protocol, continuous transmission protocol and result transmission protocol. See [Chapter 2.4 Serial Port Connection for Serial port terminals](#).

Refer to [110612120004 GMC-X802 Standard Communication Manual](#).for details of the communication protocol and modbus address.

Chapter 13: Procedure Description

13.1 Timing Diagram

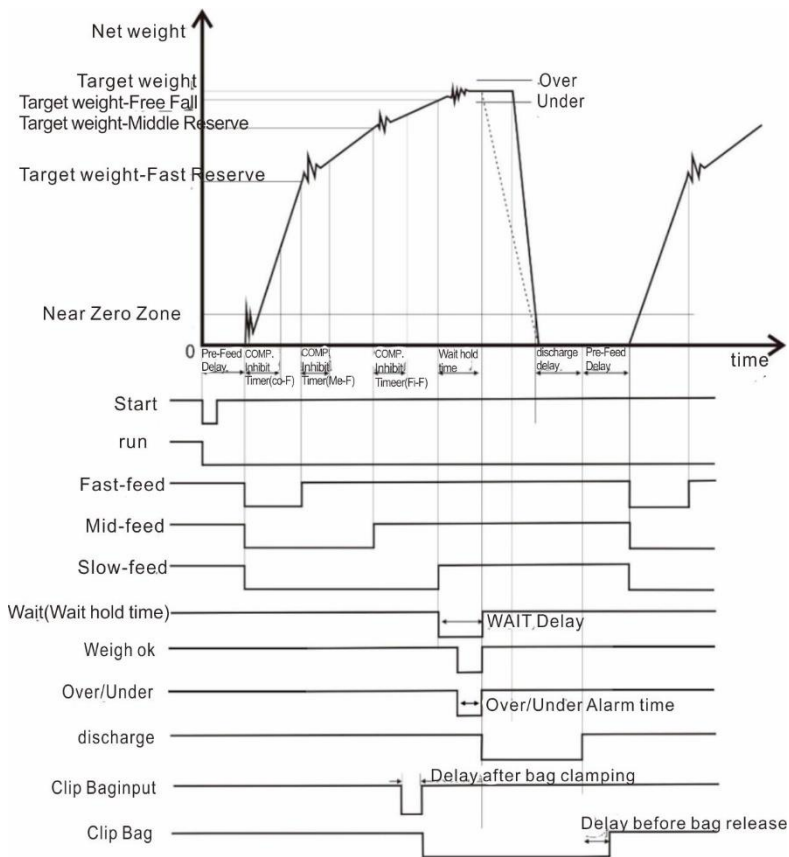

Note: The MODBUS address of formula parameters and formula cumulative parameters in the feeding process is **41001~48000**.

13.2 Flow Chart

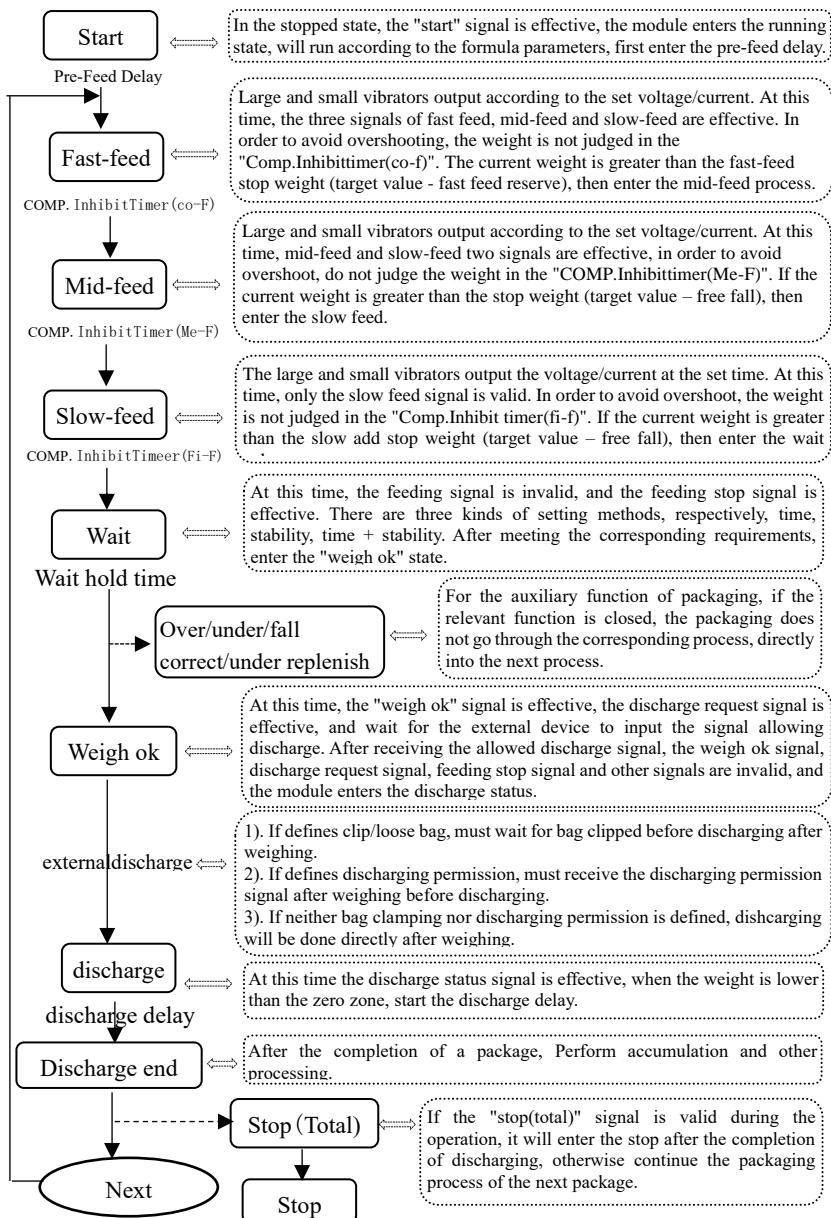

Chapter 14: Feeding mechanism

The module supports a variety of feeding mechanisms, commonly used pneumatic, vibrator, belt pulse, stepper motor. Related functions will have corresponding outputs in fast feed, mid feed and slow feed.

1) Pneumatic feeding mode

Only need to use the output of fast feed, mid feed, slow feed.

2) Vibrator feeding mode

First of all, confirm the type of vibrator (PLC address 40303~40304) and analog mode (PLC address 40395~40396) according to the mechanical structure, and then connect the analog output port of the instrument, and set the analog parameters of fast-feed and slow-feed in the formula parameters. When feeding, the instrument will output control vibrator for feeding according to the set fast feed, mid-feed and slow-feed analog value at each stage.

3) Belt feeding mode

First of all, we need to define the output "belt feeding pulse" in the PW1~PW6 of the IO, apply the parameter belt feeding frequency conversion time (PLC address 40397~40398), and then set the fast-feed and slow-feed frequency in the formula parameters. When feeding, the instrument will output pulse to control the belt feeding according to the frequency of the set fast-feed, mid-feed and slow-feed stages.

4) Stepper motor feeding mode

First, you need to define the output "feeding pulse" in PW1~PW6 in the IO module. The stepper motor method controls the open or close of the feeding gate, and the IO module involved are: O53 (A feeding pulse)/O54 (A feeding direction signal)/O55 (B feeding pulse)/O56 (B feeding direction signal), I49 (A feeding gate closed in place)/I50 (B

feeding gate closed in place). (I49/I50 signals are determined by the in place signal type).

There are five groups of motor parameters involved, which are determined by the motor group number (Modbus address 41127~41128) used in the current recipe. For specific descriptions of the feeding motor related parameters, please refer to the Modbus address table (44005~44046)

Take the fast-feed\mid-feed\slow-feed process of A scale as an example:

Fast-feed process: The instrument controls the output of O54 (A feeding direction signal) to ensure that the motor rotates in the direction of the gate opening. Then O53 (A feeding pulse) outputs pulses according to the set A scale feeding motor frequency to control the feeding stepper motor to rotate in the direction of the gate opening. When the number of O53 (A feeding pulse) reaches the set value (A scale feeding fast-feed pulse number), the pulse signal stops outputting and the feed gate stops rotating. At this time, it is in the fast-feed state.

Mid-feed process: ① Directly start mid-feed, O53 (A scale feed pulse) outputs pulses according to the set A scale feed motor frequency, controls the feed stepper motor to rotate in the direction of gate opening, O53 outputs (A feed pulse) and stops outputting pulse signals after the number reaches the set value (A scale feed mid-feed pulse number), and the feed gate stops rotating, at this time it is in mid-feed state; ② When switching from fast feed to mid-feed, O53 (A feed pulse) outputs pulses according to the set A scale feeding motor frequency, controls the feed stepper motor to rotate in the direction of gate closing, O53 (A Scale feed pulse) stops outputting pulse signals after the number reaches the set value (A scale feed fast feed pulse

number - A scale feed mid-feed pulse number), and the feed gate stops rotating, at this time it is in mid-feed state.

Slow feed process: ① Directly start slow feed, O53 (A scale feed pulse) outputs pulses according to the set a scale feeding motor frequency, controls the feeding stepper motor to continue to rotate in the direction of gate opening, and stops outputting pulse signals after the number of O53 (A scale feed pulse) reaches the set value (A scale feeding slow feed pulse number), and the feeding gate stops rotating, and it is in slow feeding state. ② When switching from medium feed to slow feed, O53 (A scale feed pulse) outputs pulses according to the set A scale feed motor frequency, controls the feeding stepper motor to rotate in the direction of gate closing, and stops outputting pulse signals after the number of O53 (A scale feed pulse) reaches the set value (A scale feeding mid feed pulse number - A scale feeding slow feed pulse number), and the feeding gate stops rotating, and it is in slow feeding state.

Stop Feeding: O53 (A feeding pulse output) outputs pulses according to the set A scale feeding motor frequency, controls the feeding stepper motor to continue to rotate in the direction of closing the gate, and stops outputting pulse signals after detecting that I31 (A feeding gate is closed in place) input is valid, and the feeding gate stops rotating, at which time the feeding is completely closed. Note: If the closing process time exceeds the feeding gate closing timeout time set by the feeding gate closing timeout time, and the instrument has not detected I49 (A feeding door is closed in place), then the instrument will stop O53 (A feeding pulse) and alarm A scale feeding gate closing timeout.

Chapter15: Discharge mechanism

The module supports 7 types of discharge modes (0: pneumatic discharge, 1: motor rotary discharge, 2: motor positive and negative rotation (dual photoelectric), 3: motor positive and negative rotation (single photoelectric), 4: motor positive and negative rotation without photoelectric, 5: stepper motor rotation (photoelectric), 6: stepper motor positive and negative rotation). The necessary parameters and timing diagrams of the relevant modes are described below.

1) Pneumatic discharge mode

IO definition: discharge gate opening (IO output)

Formula parameters: discharge delay, zero zone value

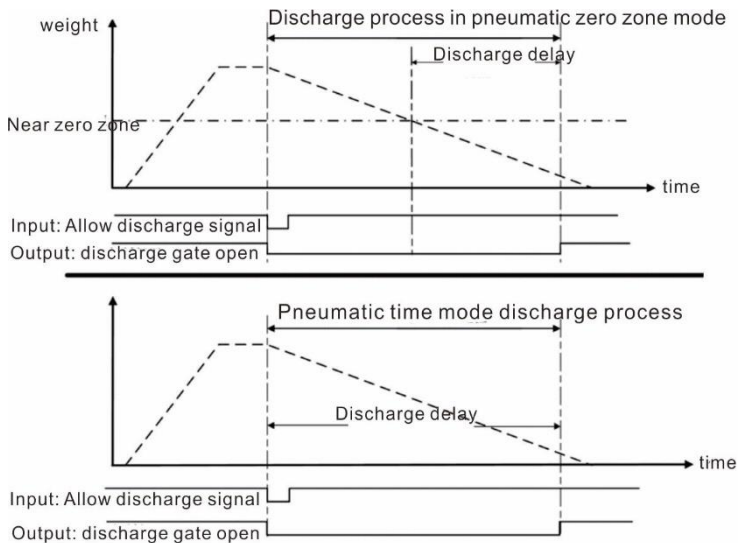

2) Motor rotation discharge mode

IO definition: discharge gate opening (IO output), discharge gate closing in place (IO input)

Formula parameter: discharge times

Application parameter: open gate shake time

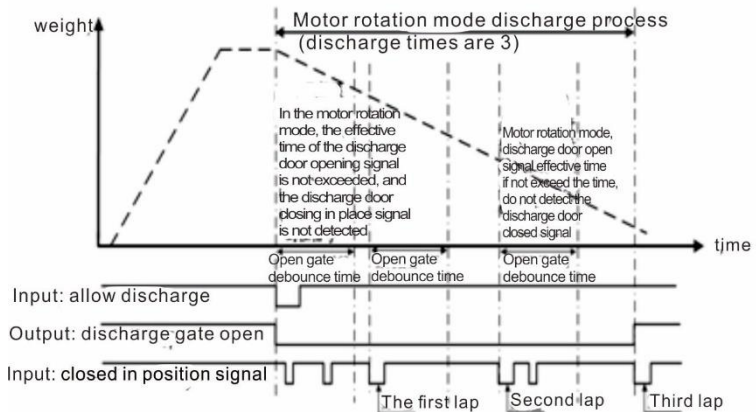
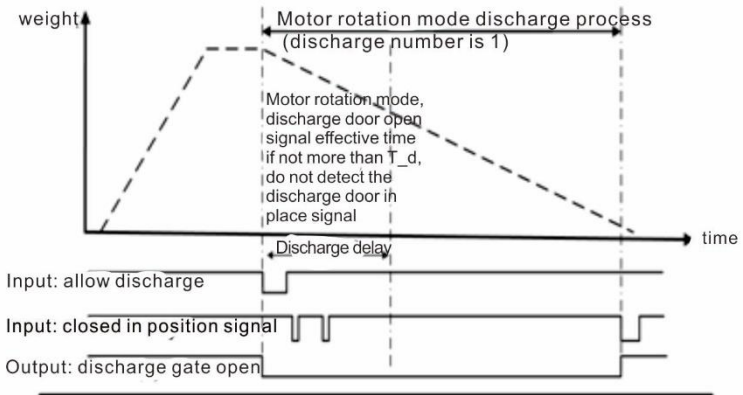

3) Motor positive and negative rotation (dual photoelectric) discharge mode

IO definition: discharge gate(IO output), discharge gate(IO output), discharge gate in place (IO input), discharge gate in place (IO input)

Formula parameters: discharge delay, zero zone value

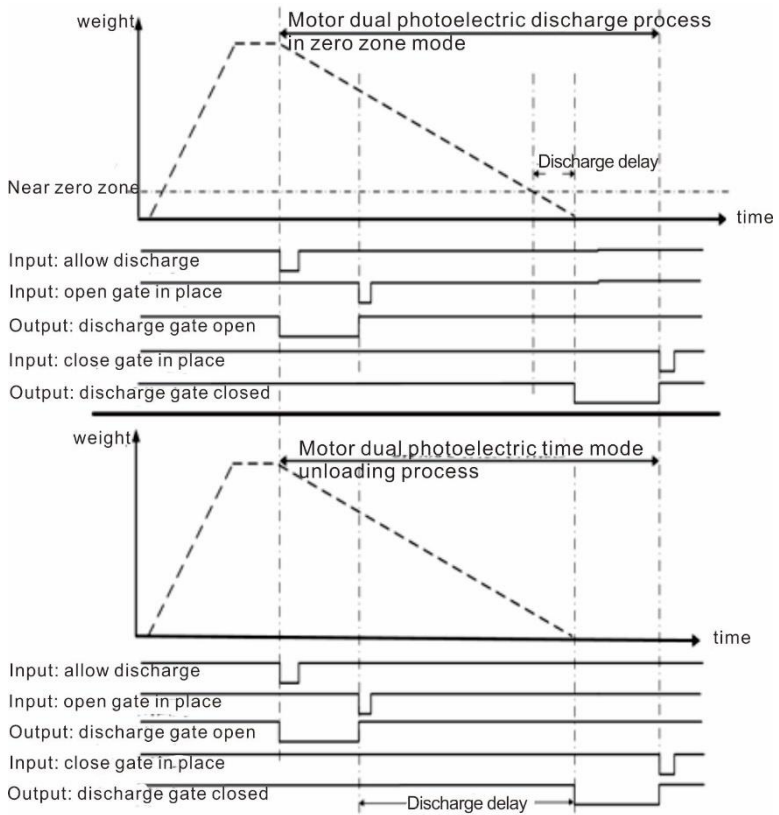

4) Motor positive and negative rotation (single photoelectric) discharge mode

IO definition: discharge gate opening (IO output), discharge gate closing (IO output), discharge gate closing in place (IO input)

Application parameter: discharge gate opening time

Formula parameters: discharge delay, zero zone value

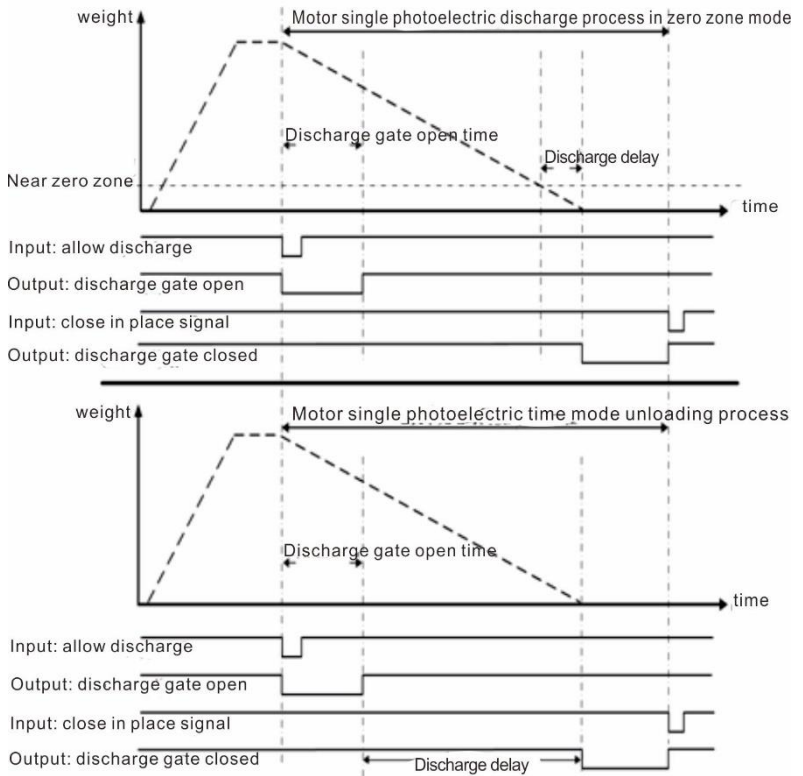

5) Motor positive and negative rotation (no photoelectric) discharge mode

IO definition: discharge gate opening (IO output), discharge gate closing (IO output)

Application parameters: discharge gate opening time, discharge gate closing time

Formula parameters: discharge delay, zero zone value

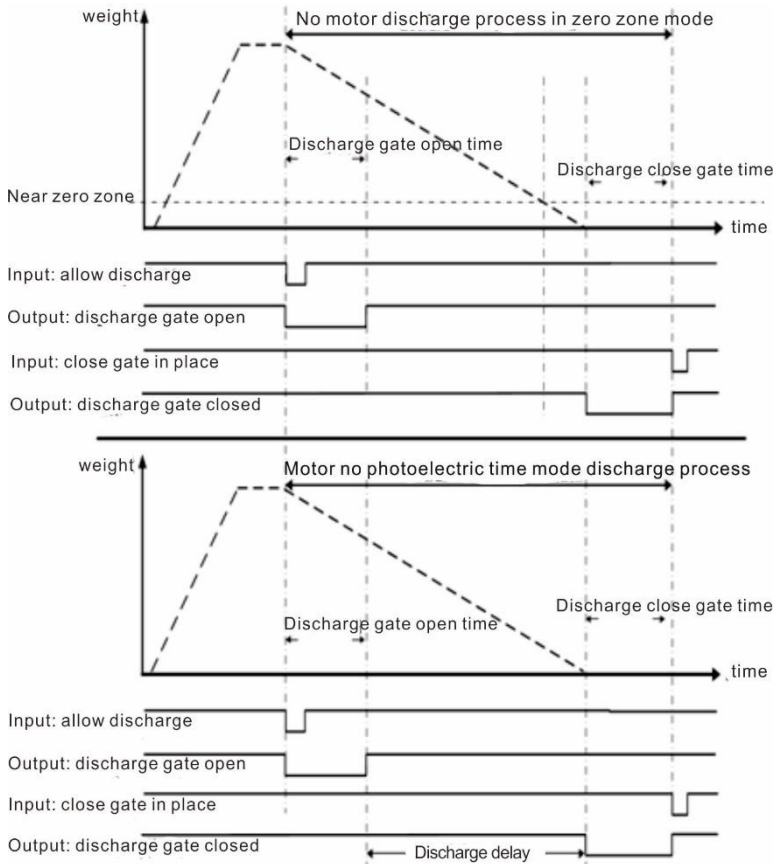

6) Stepper motor rotation discharge mode

IO definition: discharge pulse (IO output), discharge gate in place (IO input)

Application parameters: opening gate shake time, discharge motor work frequency, discharge motor starting frequency, discharge motor acceleration time.

Formula parameters: discharge times, zero zone value

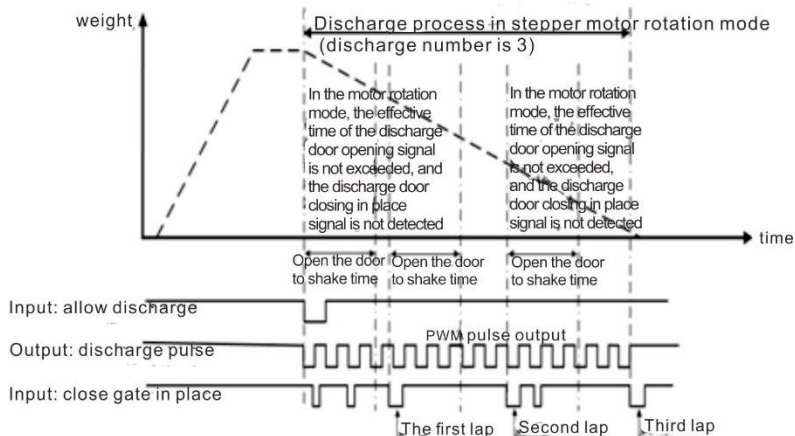
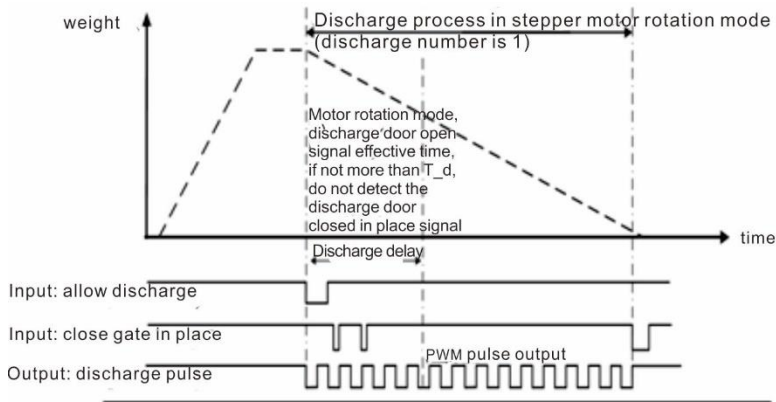

7) Stepper motor positive and negative discharge mode

IO definition: discharge pulse (IO output), discharge gate opening (IO output), discharge gate closing (IO output), discharge gate in place (IO input)

Application parameters: number of stepper motor opening pulse, discharge motor operating frequency, discharge motor starting frequency, discharge motor acceleration time.

Formula parameters: discharge delay, zero zone value

Note: "Discharge gate open" and "discharge gate close" in the figure are used as the direction signals of the stepper motor. If the direction of the discharge stepper motor is not correct, you can switch the two or set the reverse on the stepper motor driver.

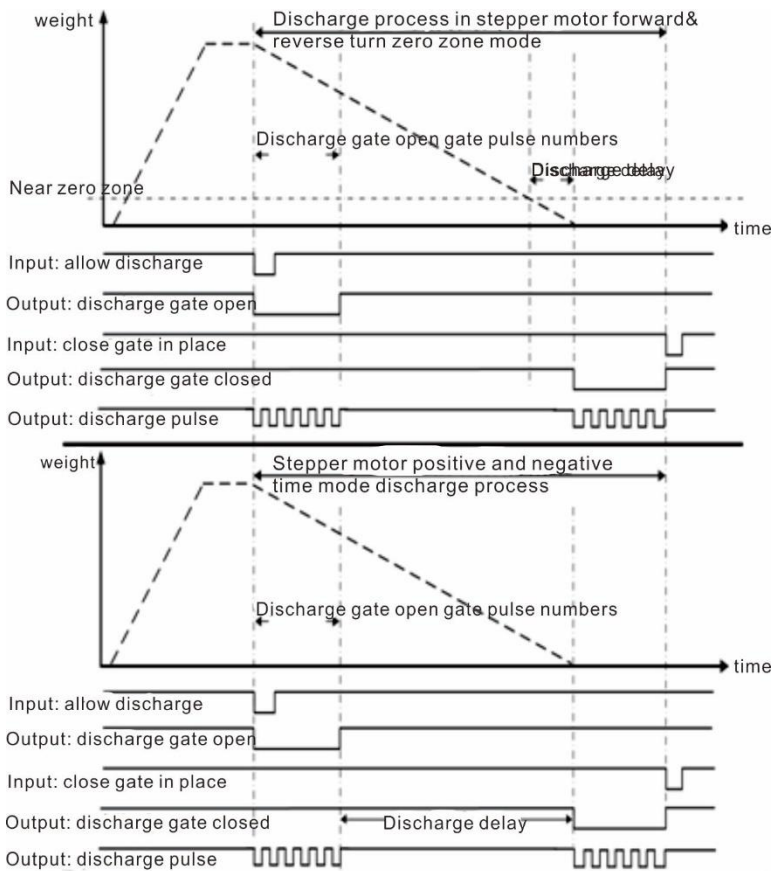

Chapter 16: Discharge interlock function

Gmc-x802 has four working modes (0: standard mode, 1: host mode, 2: slave mode, 3: single hopper independent mode), which can be set through the communication address 0300~0301 (PLC address 40301~40302).

Note: the scale mode configuration application parameter MODBUS address is **40301~41000**.

16.1 Standard mode

When there are only two scales and cannot be discharged at the same time, the operating mode should be set to standard mode, with the 2 channels of the instrument sharing an identical target value. At this time, the two channels inside the module will be interlocked in discharge, when a channel weighs ok, the first will judge whether another channel is discharging, if yes, wait for the discharging to be completed, if not, the output to the external PLC discharging request signal, PLC to allow the discharging signal before discharging, so as to achieve the same time only one channel in discharging.

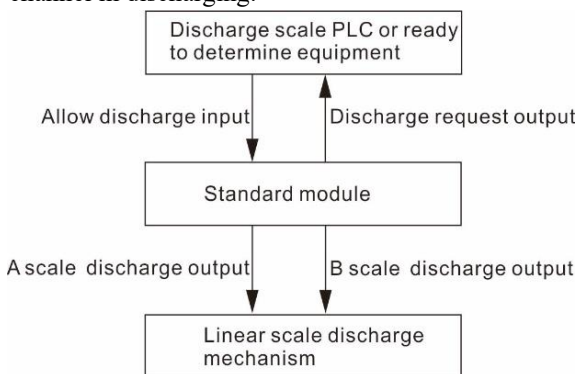

16.2 Single hopper independent mode

When the two scales can discharge at the same time and do not interfere with each other, the working mode should be set to the single bucket independent mode, the 2 channels are independent, using their respective target values. At this time, the two channels inside the module do not interfere with each other when discharging, when any channel is weighed, it will output the discharge request signal of the corresponding

channel to the external PLC, and the PLC will discharge the material after allowing the discharge signal

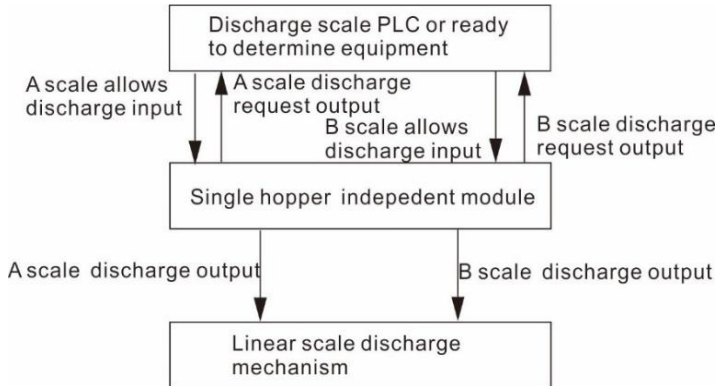

16.3 Multi-channel combination mode

When there are four or six scales, and can not be discharge at the same time, at this time to use multiple modules, you need to set one module to the host mode, the other module is set to the slave mode, multiple modules through the IO connected to each other, the host must not only control the two channels of its own discharge, but also control the two channels of the slave machine discharge, When the host and the slave machine all the channels of any channel weigh OK, the host will determine whether the other channel is discharging, if it will wait, not by the host to the external PLC output discharging request signal, and then wait for the discharging signal, so as to ensure that the multi-channel interlock, orderly discharging.

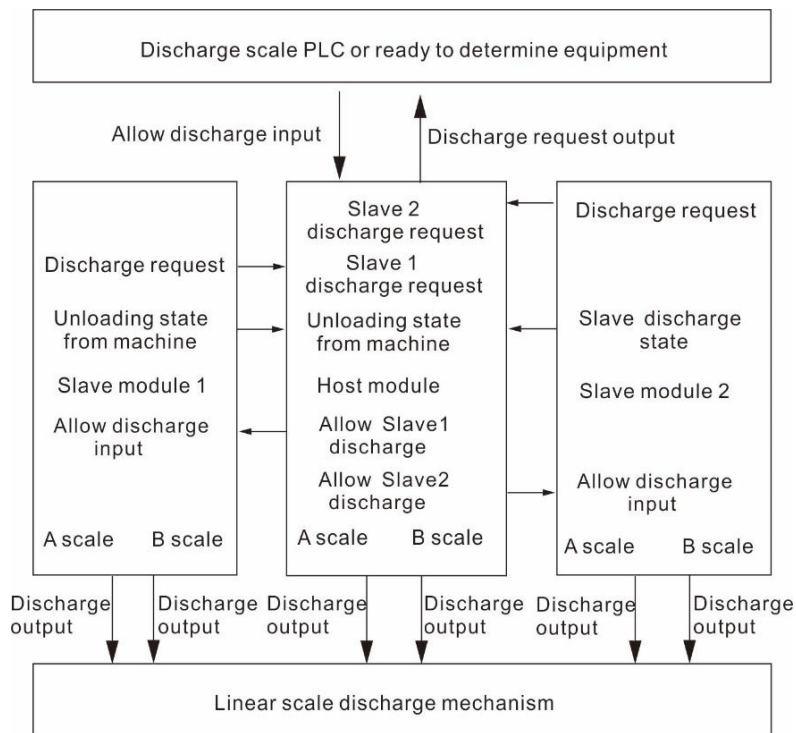

Chapter17: Error and alarm information

Err-00: The power-on zero is out of range

Err-01: The power-on zero is unstable

Err-02: The Zero is out of range

Err-03: The Zero is unstable

Err-04: Clear zero voltage-negative overflow

Err-05: Clear zero voltage-positive overflow

Err-06: The target value at startup is 0

Err-07: Reserve is wrong at startup

Err-08: Weight is OFL at startup

Err-09: failure to clear before feeding alarm

Err-10:Over and under alarm

Err-11: The discharge gate is not closed when starting

Err-12: The power-on discharge gate is not closed

Err-13: Feed timeout

Err-14: Discharge time out

Err-15: The operation is not allowed in the vibrator test

Err-16: The I/O test status does not allow the operation

Err-17: The Empty material status does not allow the operation

OFL: The Loadcell voltage or weight is too large

-OFL: The Loadcell voltage or weight is too small

Chapter 18: Instrument size (mm)

