

Weighing Instrument Selection Manual



ENTERPRISE PROFILE



30⁺
years
Industry Experience



40⁺
Country Sales



200⁺
R&D Patent



2000⁺
Applications

General Measure established in 1993, as one of China's earliest industrial weighing company who is also a national high-tech enterprise, has over 50 people in the R&D team. For decades, we have been committed to improving the automatic process of industrial weighing and the precision of weighing control.

In 2003, we began to open the overseas market. Since 2006, General Measure dominated the high-end market and occupying more than 25% of the market in China. To expand the global business scale, we have been focusing on overseas markets since 2012. It has been seen that the average sales growth is above 30% every year.

We will continue to provide reliable industrial weighing indicators and equipment with excellent performance and weighing solutions with innovative value to our partners. Listening, Innovating, and growing together is our value, which guides us to achieve win-win cooperation by helping clients achieve their goals.

CONTENTS**01****Weighing Transmitter** 02

GMT-X1 (Digital Version Available)	02
GMT-X4	04
GMT-P1 (Digital Version Available)	07
GMT-H1 (Digital Version Available)	09
GMT-H2 (Anti-explosion Version Available)	11
GM7702	13
GM8802S-T	15

Weighing Controller 17

GMC-X3	17
GMC-X904-2/D	19
M04 Series	21
GMC-P7	32
GMC-P7(F8) (Digital Version Available)	34
GM9907 Series	36

Others 46

Remote Display GM8892/GM8895	46
Junction Box GM-JX-M	48

GMT-X1

Weighing Transmitter

(Digital Version Available)



GMT-X1, a DIN rail-mounted weighing transmitter for industrial automation, can be used in various system weighing applications, such as weight checking, loss-in-weight, liquid filling, batching, vessel and silo weighing, etc. Through Bluetooth, it can be connected to Weasy App for configuration and monitoring.



SOFTWARE HIGHLIGHTS

- Liquid filling software selectable ;
- Calibration without weights (by loadcell sensitivity value) ;
- Printer function ;
- Self-testing for I/O and communication port ;
- Self-editable boot screen ;



HARDWARE HIGHLIGHTS

- Stainless steel case with compact design ;
- Different configuration choice, a variety of combinations ;
- Standard: RS485 + RS485/RS232(Selectable)
- Option 1** 3 Input 5 Output or 3 Input 4 Output relay (Optional) ;
- Option 2** RS485+16bit Analog or 2 Input 4 Output or CAN communication;
- Option 3** Modbus TCP or Ethernet/IP or Profinet or Profibus DP or CCLink IE;
(Hardware Option1,2,3 can be selected at the same time) ;
- Bluetooth communication.

Digital Version

Standard:

- RS232 or RS485 selectable;
- RS485 for digital loadcell interface;

Options:

Same as common version;



Standard Specification

	Model	GMT-X1	GMT-X1 Digital Version	
General Specifications	Power Supply	DC 24V(12~30VDC)		
	Working temperature	-10°C~40°C		
	Maximum humidity	90% RH.without dew		
	Testing standards	Class III 6000 e,1μV/d		
	Power consumption	About 5W		
	Measurement Parameters	A/D performance	24 bit Delta-Sigma	N/A
A/D conversion speed		50~960 times/sec	N/A	
Non-linearity		0.01%F.S	N/A	
Gain drift		10PPM/°C	N/A	
Input sensitivity		0.1μV/d	N/A	
Display Accuracy		1/1,000,000	1/1,000,000	
Weighing Platform Requirement		1 simulation scale interface can connect up to 8 load cells with 350Ω, Support sensitivity in 1mV/V、2mV/V、3mV/V	1 standard RS485 digital loadcell interface	
Sensor power supply		DC 5V 200mA(Max)	DC12V 250mA, up to connect with 8 digital load cells	

Application

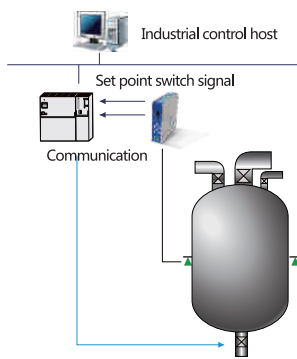

Set point weighing application

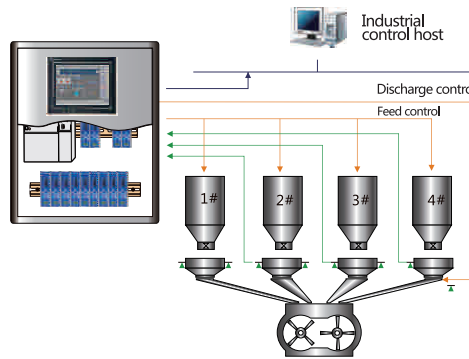

Multi-material batching application

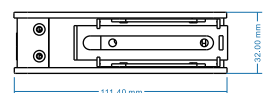
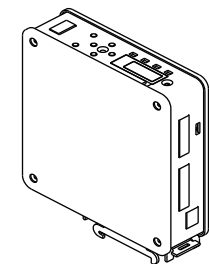
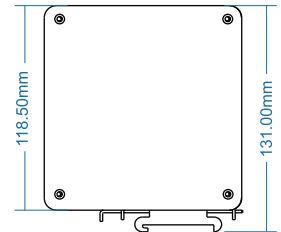

GMT-X4

DIN Rail Mount Four-Channel Weighing Transmitter



GMT-X4 is a DIN rail mounted weighing transmitter with four-channel. It has the characteristics of compact design, stable performance, and easy operation, which can be used for various weighing applications, such as weight checking, loss-in-weight, liquid filling, batching, vessel and silo weighing, etc.



HARDWARE HIGHLIGHT



- Stainless steel housing with compact design(62X134X128mm);
- Different configuration choices, a variety of combination;

Standard

- ① 4-channel of 6-wire load cell interfaces;
- ② RS485 & RS232;
- ③ 4 Input 8 Output I/O;

Option1

Modbus TCP /IP or EtherNet/IP or ProfiNet or EtherCat or CCLink IE;

Option2

4-channel analog output;

Option3

CAN communication;

(Option1, 2, 3 can be selected at the same time.)



SOFTWARE HIGHLIGHT

- Zero point reset function: support resetting the zero point as before power failure when re-powering;
- Theoretical value calibration, stable within 3s of the calibration process automatically;
- Remote monitoring and configuration by PC with Modbus TCP connecting up to 6 devices at once;
- Input anti-vibration function, which time can be set.

GMT-X4

Weighing Transmitter (Intelligent Junction box)



GMT-X4 weighing indicator with intelligent junction box built in can easily monitor the defaulted load cell.



FEATURES



- Main display
- Up to 6 digits

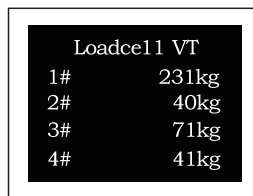

- Weight display
- Individual load cells

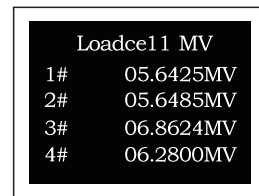

- Millivolt display
- Individual load cells



- Main display
- Error notice
- Load cell failure

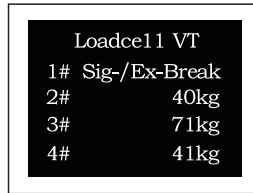

- Weight display
- Error notice
- Defaulted load cell

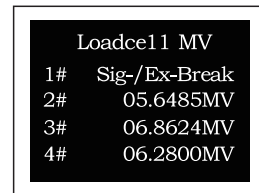

- Millivolt display
- Error notice
- Defaulted load cell



HARDWARE HIGHLIGHT

- Stainless steel housing with compact design(62X134X128mm);

Standard

- ① 4-channel of 6-wire load cell interfaces;
- ② RS485 & RS232;
- ③ 4 Input 8 Output I/O;

Option1

Modbus TCP /IP or EtherNet/IP or ProfiNet or EtherCat or CCLink IE;

Option2

1-channel analog output;

Option3

CAN communication;

(Option1, 2, 3 can be selected at the same time.)



Specification

General Specifications	Model	GMT-X4
	Power	DC 24V \pm 5%
	Size	62mm \times 134mm \times 128mm
	Weight	Approx. 880g
	Operating Environment	-10 \sim 40°C; 90%R.H, No Condensation
	Storing Environment	-40 \sim 60°C; 90%R.H, No Condensation
	Power Dissipation	10W
Measurement Parameters	Weighing Platform Excitation Voltage	5V, 200mA(MAX)/channel
	Weighing Platform Requirement	4 simulation scale interface, can connect up to 40 load cell with 350 Ω , support sensitivity 1mV/V, 2mV/V, 3mV/V
	Sensitivity	0.1uV/d
	Non-Linearity	0.01% F.S
	A/D Conversion Speed	50/60/100/120/200/240/400/480/800/960/SPS
	Maximum Display Accuracy	1/1,000,000

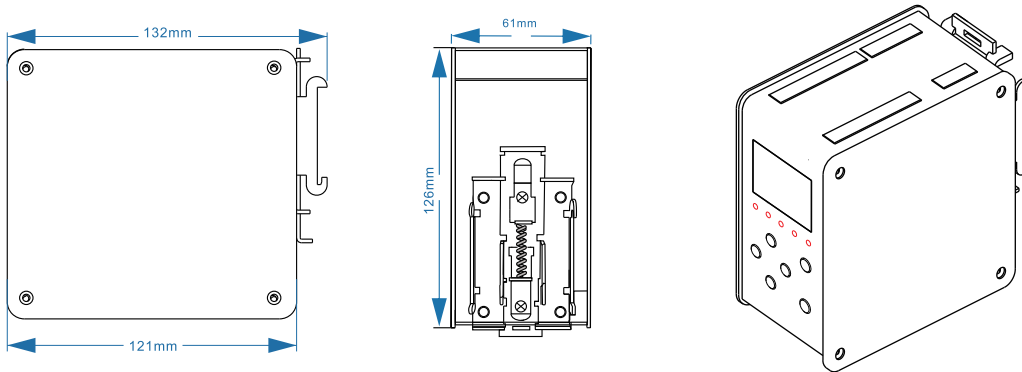

Application Diagram

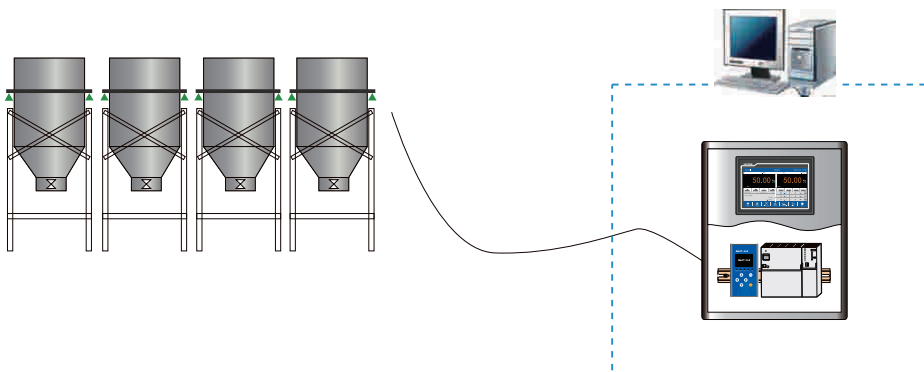

Multi-material batching application

GMT-P1

Weighing Transmitter

(Digital Version Available)



The GMT-P1 is a panel/harsh-mounted weighing transmitter that offers exceptional reliability, advanced filtering, and tested ability to perform stably under interference of harsh industrial environments. It is customized for dynamic weighing systems with the highest demand for reliability, response speed and accuracy.



FEATURES

- OIML R76 approval;
- With second generation anti-vibration filter;
- Support calibration without weights;
- 1,000,000 weight resolution ability;



HARDWARE HIGHLIGHTS

Standard

- RS232 or RS485 selectable by switch;
- 1 input 2 output I/O;

Options

- Single network port + RS232/RS485 selectable, support Modbus;
- Dual network ports, support ModbusTCP;
- Profinet or Ethernet IP or EtherCAT or CCLink IE;
- Analog output.

Digital Version

Standard

- RS232 or RS485 selectable by switch;
- RS485 for digital loadcell interface;
- 1 input 2 output I/O;

Options

- 16-bit analog output (Voltage/Current Type);

Standard Specification

General Specifications	Model	GMT-P1	GMT-P1 Digital Version
	Power Supply	DC 24V±5%	
	Working temperature	-10°C~40°C	
	Maximum humidity	90% RH.without dew	
	Testing standards	Class III 6000 e,1μV/d	
	Power consumption	About 10W	
Measurement Parameters	A/D performance	24 bit Delta-Sigma	N/A
	A/D conversion speed	30/60/120/240/480/960 times/sec	N/A
	Non-linearity	0.01%F.S	N/A
	Gain drift	10PPM/°C	N/A
	Input sensitivity	0.01μV/d	N/A
	Maximum input voltage	0~15mV	N/A
	Display Accuracy	1/1,000,000	1/1,000,000
	Load cell excitation	DC 5V,200mA(Max),Up to 8 load cells (350Ω) can be connected	DC12V, 250mA, up to connect 8 digital load cells
	Dust/water protection	The IP65 display when mounted into a panel	

Application

Unit:mm

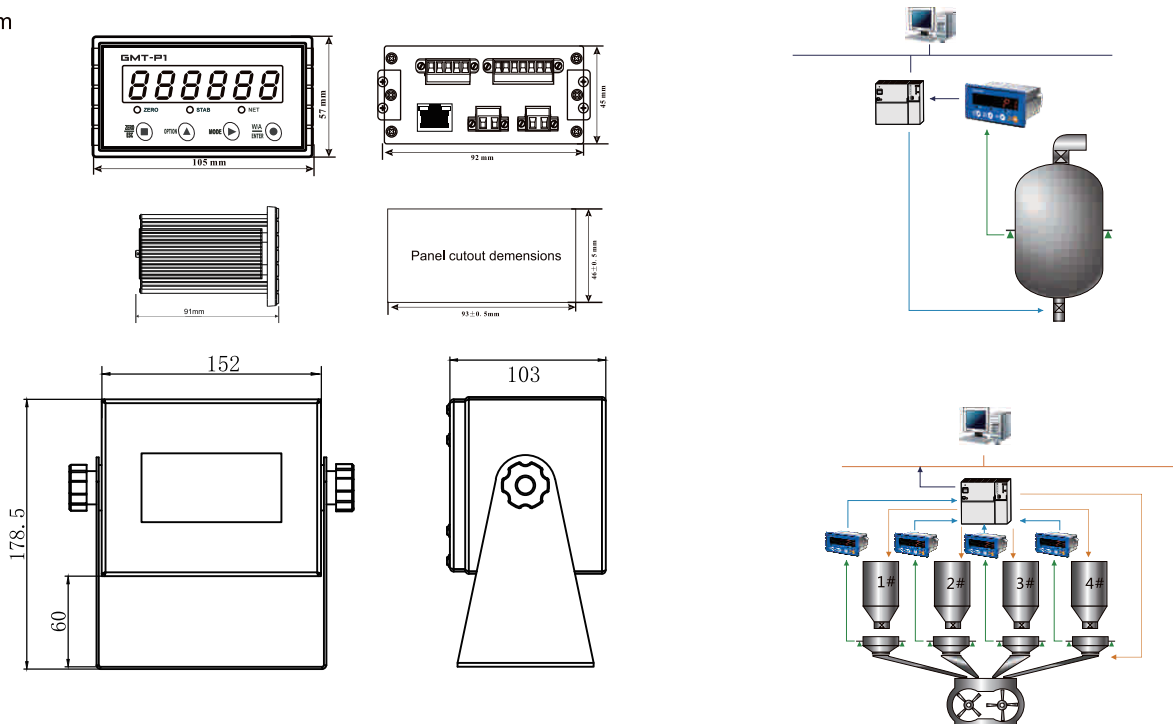

GMT-H1

Weighing Transmitter

(Digital Version Available)



PRODUCT INTRO

GMT-H1 weighing transmitter is designed for industrial weighing application. It's harsh mount, **IP65** protection widely used in silo and vessel weighing field.

FEATURES

- Anti-dust and waterproof harsh mount case;
- 6-wire loadcell interfaces, connecting up to 8 load cells in 350Ω;
- Support theoretical data calibration;
- Support **GPRS, Modbus-RTU, Modbus-TCP/IP, RS485** for communication;
- The function of automatic upload relevant weighing data;
- Through IO port to get the information of material level.

DIGITAL VERSION

Standard

- RS485 for digital loadcell interface;
- RS485 support ModbusRTU;
- Standard network port, support ModbusTCP;
- 3 inputs 3 outputs, 3 self-defined I/O (input or output);

Options

- GPRS data transmission function;



Standard Specification

	Model	GMT-H1	GMT-H1 Digital Version
General Specifications	Power	AC 90~260V 50Hz(or 60Hz)±2%	
	Temperature	-20°C~60°C;90% RH.without dew	
	Power consumption	About 10W	
	Weights	750g	
	A/D conversion	24 bit Delta-Sigma	N/A
Measurement Parameters	Sampling rate	Sampling rate, initial value:100times/sec, range: 50,60,100,120,200,240,400,480 times/sec	N/A
	Nonlinearity	0.01%F.S	N/A
	Gain drift	10PPM/°C	N/A
	Sensitivity	0.1μV/d / 0.5μV/d	N/A
	Input range	Max 0.02~15mV	N/A
	Maximum display accurarcy	1/100,000	1/100,000
	Weighing platform load cell	1 simulated weighing platform load cell interface can connect up to 8 load cells that is in 350Ω, and the sensitivity in 1mV/V, 2mV/V, 3mV/V.	1 digital load cell interface, up to connect to 8 load cells
	Load cell excitation	DC 5V 200mA(Max)	DC 12V 250mA
	I/O Interfaces and Communications	RS485(Standard); Support ModbusRTU, continuous transmission protocol	
RJ45(Standard); Support Modbus-TCP, continuous transmission protocol			
GPRS data transmission function			
Fixed IO: 3 Input, 3 Output			
Optional IO: 3 more (can be selfdefined as output or input)			

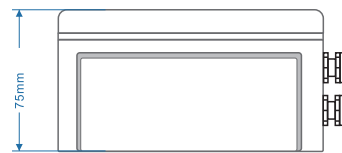
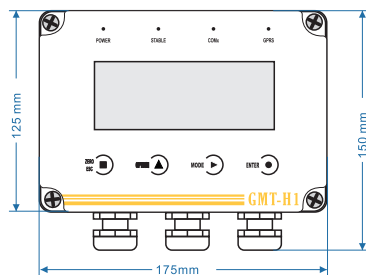

Unit : mm

Application

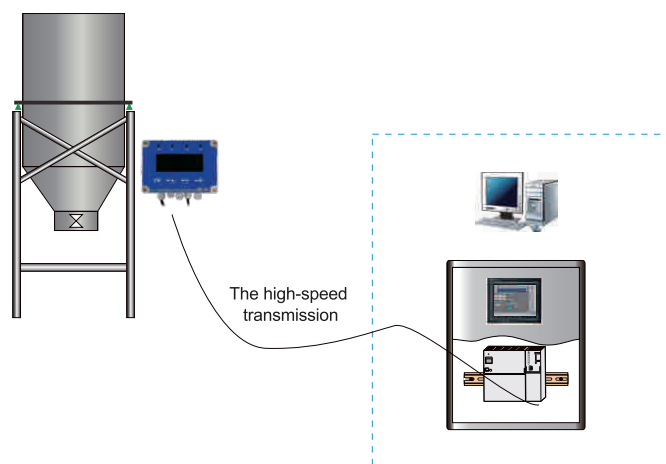

GMT-H2

Wall/Desk Mount Weighing Transmitter

(Anti-explosion Version Available)



GMT-H2 is a wall/desk-mount weighing transmitter, with stainless steel shell which reaches IP65 protection. 2-inch LED display with 6 digits and 6 indicator lights. It can be widely used in the industrial automation fields, such as silo weighing, platform weighing, weight checking, loss-in-weight, liquid filling, batching, and so on.

Anti-explosion Version Available

Anti-explosion version GMT-H2ex is suitable for explosive industrial field. Cast aluminum explosion-proof enclosure, 4 metal buttons, AC220V / DC24V dual power supply configuration.

Ex d IIB T6 Gb / Ex tD A21 IP66 T80°C



HARDWARE HIGHLIGHTS



Standard

- 2 RS485, 1 RS232 ports;
- 4 in 6 out I/O ports;



Options

- 1 analog output;
- Modbus TCP, or Profinet(support Siemens PLC connection), or Ethernet IP (Omron or Schneider PLC connection) or EtherCAT (developing phase, Omron or Schneider PLC connection).

SOFTWARE HIGHLIGHTS

- Zeroing and taring functions;
- Analog functions;
- Serial port communication functions;
- Simple weighing functions: weight collect, filter and display;
- Calibration with or without weights, support 5 points calibration with weights;
- Print function;
- I/O preset point function;

Standard Specification

General Specifications	Model	GMT-H2	GMT-H2ex
	Power Supply	DC 24V (12~30VDC)	AC220V / DC24V dual power supply configuration
	Working temperature	-10°C~40°C	
	Maximum humidity	90% RH.without dew	
	Testing standards	Class III 6000 e, 1μV/d	
	Power consumption	About 10W	
Measurement Parameters	A/D performance	24 bit Delta-Sigma	
	A/D conversion speed	30/60/120/240/480/960 times/sec	
	Non-linearity	0.01%F.S	
	Gain drift	10PPM/°C	
	Input sensitivity	0.1μV/d	
	Maximum input voltage	0~15mV	
	Display Accuracy	1/1,000,000	
	Load cell excitation	DC 5V,200mA(Max),Up to 10 load cells(350Ω) can be connected	

Dimension

unite:mm

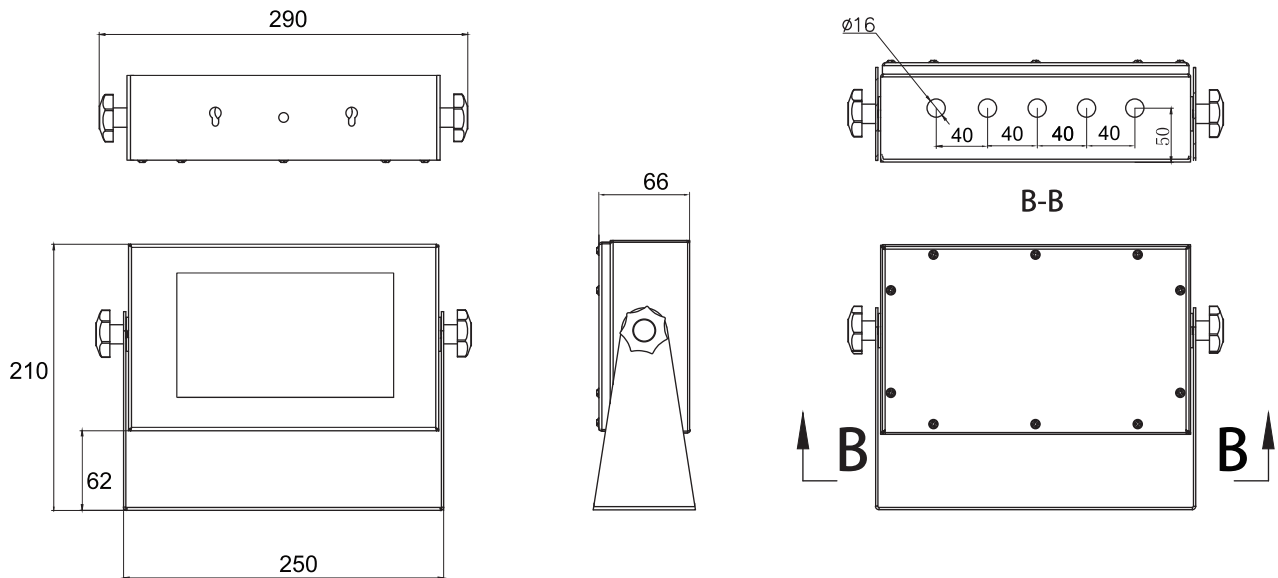

GM7702

Weighing Transmitter



GM7702, a digital weighing transmitter with the standard dimension, is suitable for mounting on DIN rail in many industrial fields. Small size and compact design make it ideally integrate with whole weighing sector. Due to its high practicability, stability and easy operation, GM7702 can be widely applied to the industry of feeds, chemical, concrete and bitumen mixing, metallurgy smelting, etc.

DESCRIPTION



Standard

- With RS232/485 serial ports and support remote control;
- Support tare, preset tare function;
- Equipped with 2 IN 3 OUT I/O module.



Compact Design

- Small size and compact design with standard 35mm DIN mounting;



Optional Communication

- Optional 16bit high-precision analog output: 0~24mA, 0~5V, 0~10V and user-defined analog output.



Standard specification

General Specifications	Model	GM7702
	Power Supply	DC 24V
	Working temperature	-10°C~40°C
	Maximum humidity	90% R.H without dew
Measurement Parameters	A/D performance	24 bit Delta-Sigma
	A/D conversion speed	120/240/480 t/s
	Non-linearity	0.01%F.S
	Gain drift	10PPM/°C
	Input sensitivity	0.02μV/d
	Input range	-15mV~15mV
	Maximum display accuracy	1/100,000
	Load cell power	DC 5V 100mA(Max)
	Input impedance	10MΩ
	Zero steady range	-15mV~15mV(Load cell 3mV/V)
I/O Part	Inputs	2,active low Zero/tare/trigger preset point n (n=1/2/3/4)
	Outputs	3,single drive current 500mA Stabilization/Overflow/Trigger Point n Output (n=1/2/3/4)/Upper/Middle/Lower Limit

Dimensions

Unit:mm

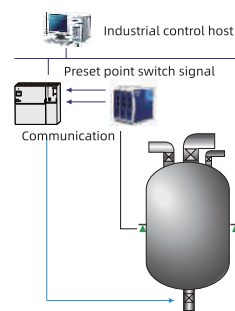
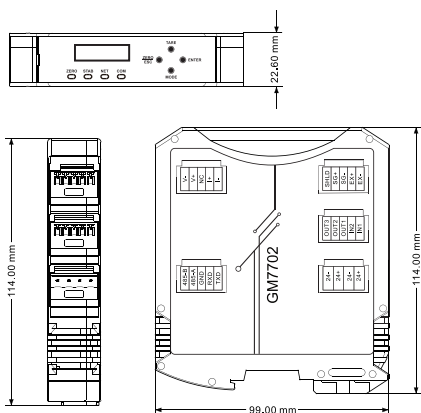

Preset point mode weighing application

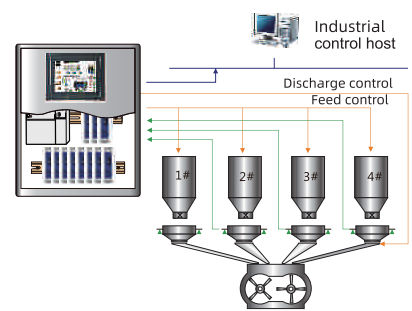

Multi-material serial weighing and networking

GM8802S-T

Rail Mount Weighing Transmitter



GM8802S-T weighing indicators are specially designed for weight transmitting in industrial fields, which have features of small volume, plenty communicating commands, stable performance, easy operation and practicability, so they are widely applied to concrete and bitumen mixing equipment, commodity industry, chemical industry and feed, etc.

DESCRIPTION



- Weigh controller module with optional preset point function;
- Easy operation and installation, equipped with **OLED** display;
- **RS485** communication as standard to connect with a **PLC**;
- A variety of expansion modules are available to support various external communication output modes.



DIMENSIONS

Unit:mm

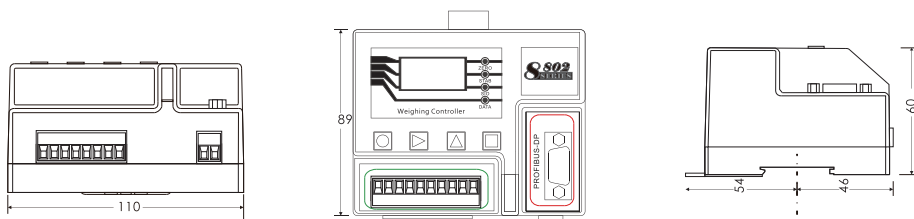

Standard specification

Measurement Parameters	Model	GM8802S-T
	A/D Conversion Method	24-bit Delta-Sigma modulation
	Zero Adjustment Range	0.02~8mV (Load cell 2mV/V)
	Nonlinearity	0.01%F.S
	Maximum Input Voltage	0.02~10mV (Load cell 2mV/V)
	Minimum Sensitivity	0.1μV/d
	Input Impedance	10MΩ
	Sampling Rate	120/240/480 t/s.
	Display Resolution	1/100,000
	Load Cell Excitation	DC5V,200mA(Max),Up to 8 load cells can be connected
General Specifications	Display Element	1.3 inch OLED screen
	Status Indicators	ZERO,STAB,SIO,DATA
	Power Source Voltage	DC 24V ±5%
	Power Consumption	Approx.10w
	Temperature and Humidity	-10°C~40°C/90% R.H or less (Condensation must be avoided)
	Dimensions	110*89*60mm (L*W*H)
	Weight	Approx.250g

Application

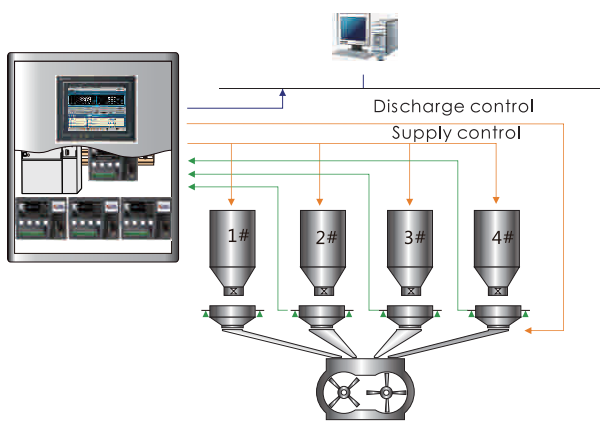

Multiple material batching machine

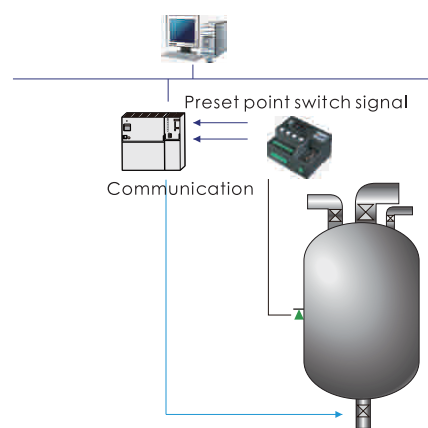

Preset point weighing controller

GMC-X3

Rail-Mount Loss-in-Weight Controller



GMC-X3 is a loss-in-weight scale control module for high precision continuous dosing applications, capable of reliable, accurate and stable dosing of liquid, powder, granular and flake dry bulk materials, reducing material waste and improving mixture consistency. It is mainly used in chemical, plastic, rare earth smelting and other industries.

Functions & Features

Weasy Functions

- Standard 1. 9.6-inch OLED display
- Optional Weintek 7-inch or 10-inch touch screen, well-designed interface, easy operation.



• Standard



• Optional

- Two permissions, prevents operator error;
- Modular design, Clear simple interface and easy operation.
- Support 4 points flow calibration, single point flow calibration, more accuracy;
- Historial data check and excel export.

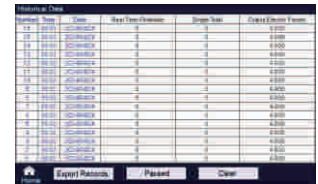
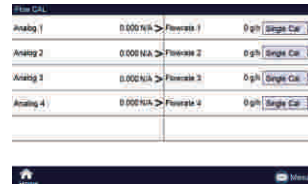
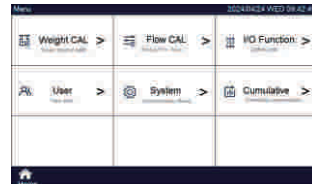

Hardware Features

- Stainless steel case, IP65 protection;
- USB Port, Easy to upgrade and import/export data;
- **Standard**
- 6-wire load cell interface;
- 1 analog output interface;
- 1 RS485, 1 RS232 interface with isolation;
- 4 inputs and 4 outputs + 4 self-defined transistor input or output interfaces;
- **Options**
- Modbus TCP /Profinet;
- 1 Analog input (current/voltage optional)+1 analog output interface;



Software Features

- New generation flow control algorithm, more stable;
- Support analog calibration, automatic/manual calibration of flow rate;
- Automatic locking and unlocking function for flow interference;
- Support two devices to access the instrument parameters function simultaneously (ModbusTCP);
- **Working modes**: ① Flow calibration mode; ② Flow rate presetting and flow rate giving mode; ③ PID control mode, segment control mode;
- Threshold anti-interference function, which makes the working process of the instrument more stable;
- Multi-material function, support up to 10 sets of material parameters, convenient to switch between different material parameters;

Standard Specification

General Specifications	Model	GMC-X3
	Power Supply	DC 24V (18~36VDC)
	Approved Environment	-10°C~40°C
	Maximum humidity	90% R.H without dew
	Testing standards	Class III 6000 e, 1 μ V/e
	Power Dissipation	15W
Measurement Parameters	Load cell excitation voltage	5V 200mA(MAX)
	Load cell connection	1load cell interface , 6-wire with compensation , up to 8 load cells with 350Ω, support 1mV/V、 2mV/V、 3mV/V sensitivity.
	Analog Input Range	0~15mV
	Input sensitivity	0.1μV/d
	Non-Linear	0.01%F.S
	A/D Conversion	480 times/sec
	Display Accuracy	1/1,000,000
Communication Interface	Standard	<ul style="list-style-type: none"> • 1 analog output interface • 1 RS485, 1 RS232 interface with isolation • 4 inputs and 4 outputs + 4 self-defined transistor input or output interfaces;
	Optional	<ul style="list-style-type: none"> • Modbus TCP /Profinet; • 1 Analog input (current/voltage optional) + 1 analog output interface;

Application Diagram

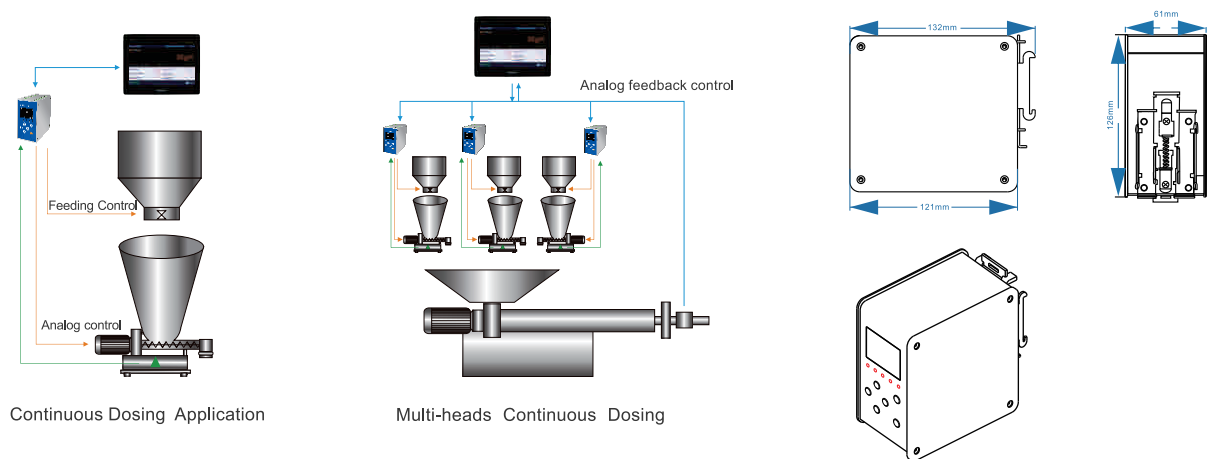

GMC-X904-2/D

Rail-Mount Packing Controller



GMC-X904-2/D single or double hopper packing controller is a DIN rail-mounted weighing controller developed for packaging machine. Stainless steel case provides strong capability in anti-interference. The new algorithm makes the weighing control faster and more accurate. It can be widely used in feed, chemical, grain and other industries.



HARDWARE HIGHLIGHT



- Stainless steel case with compact design (61*132*126mm);
- 1 RS232 and 1 Rs485;
- Modbus TCP/IP;
- I/O 12 input and 16 output;



SOFTWARE HIGHLIGHT

- Support hopper/non hopper/big bag/bulking scale structure;

Multiple working modes: pneumatic feeding/discharging; motor feeding/discharging;

Clamping and loosening bag modes: Pneumatic, stepping motor, motor single-limit, motor double-limit optional;

- Batches setting function;
- Material level control function;
- I/O logic programming control function;

Weighing and peripheral functions:

- multiple digital filtering;
- automatic zero tracking;
- auxiliary pulse;
- multiple bag tapping modes;
- sewing machine control;
- discharge vibration;
- conveyor control;



Standard Specification

General Specifications	Model	GMC-X904
	Power	DC24V \pm 5%
	Size	61mm \times 132mm \times 126mm
	Working Environment	-10~40°C
	Max. Humidity	90%R.H No Condensation
	Power Dissipation	Approx. 15W
Measurement parameters	Weighing Standard	ClassIII6000e, 1 μ V/d
	A/D Conversion	24bit Sigma-Delta
	A/D Speed	120/240/480/960 SPS
	Non-Linearity	0.01%FS
	Gain Drift	10 PPM/°C
	Sensitivity	0.02 μ V/d
	Input Millivolt	0.02~15mV
	Load cell Power	DC5V, 125mA(Max)
	Input Impedance	10MQ
	Zero Steady Range	Maximum 0.002~15mV(Load Cell 3mV/V)

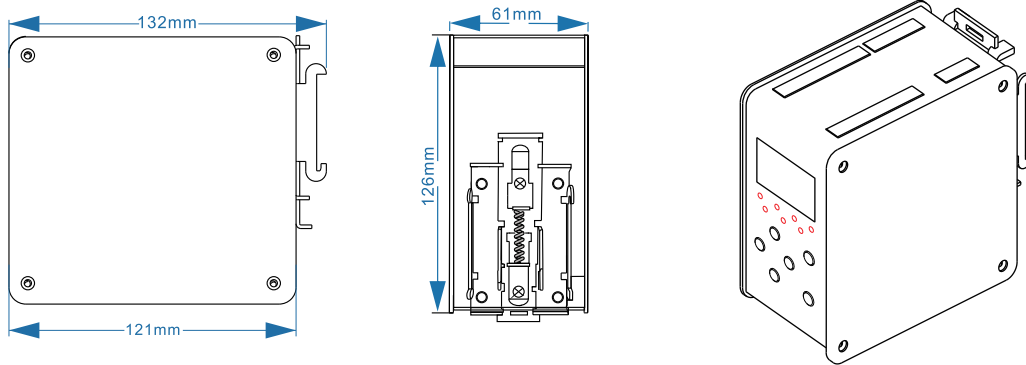

Application Diagram

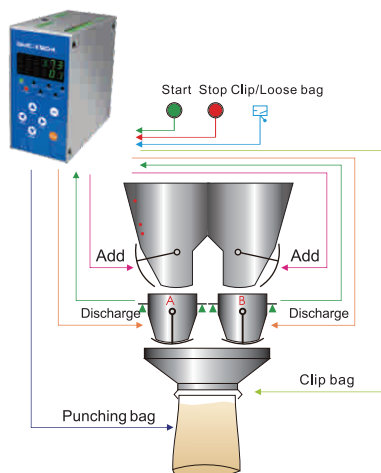

Duplex Packing Controller with Hopper

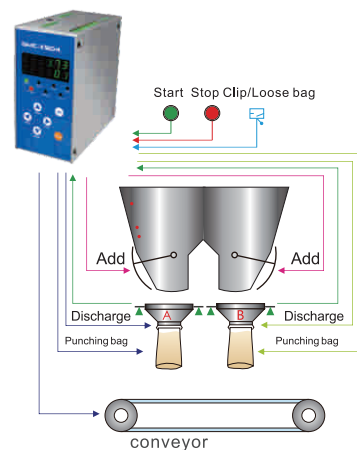

Duplex Packing Controller without Hopper

M04-2

Bagging Scale Controller



M04-2 software supports for multi-type bagging scale application.



Version Features

MULTI-Mode

Supporting the hopper/non-hopper mode and the double scale inter-locking mode (two controllers working synchronously).

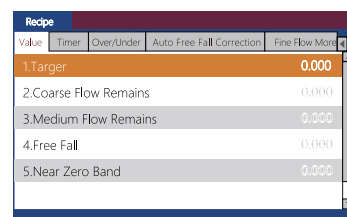
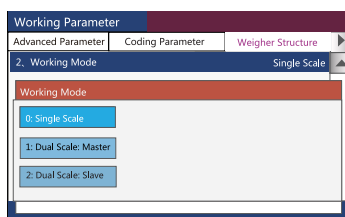

Supporting I/O tests, easy for products debugging.



Automatic three-material speed feeding control, with optional manual slow feeding function.



Multiple digital filtering to improve the anti-interference capability of the packaging scale.



Batch setting function, patting bags function, suitable for packaging powder materials



Feed control function, convenient for controlling the connection between packaging scale and feeding equipment.



Multiple levels of operating permissions, such as users, administrators and system administrator.

Button Functions

One-click button can be set for recipe selection, batch setting, parameter calibration, etc.

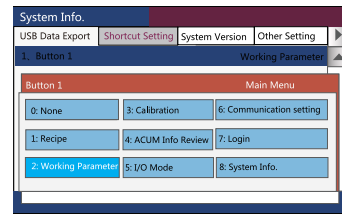
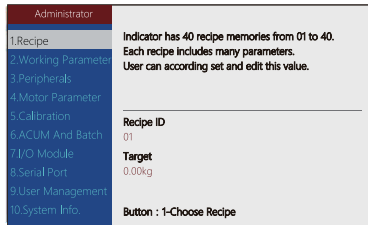

Database

It can store 20 groups of recipes. For each recipe, the target value, fast/slow feeding mode, drop value and other parameters can be set up manually.

I/O Port

8 Input/12 Output

Used to start and stop, and carry out A/B scale feeding, A/B scale unloading and other operations.

ModbusTCP

For connecting PC, PLC, Printers, etc., for reading remotely.

RS485+RS232

For connecting PC, PLC, Printer, Label Printer, Remote Display, or other external devices, for reading and setup remotely.

USB

For importing and exporting recipes, works, I/O function, communication and other parameters, upgrading system software, customizing boot screen, etc.

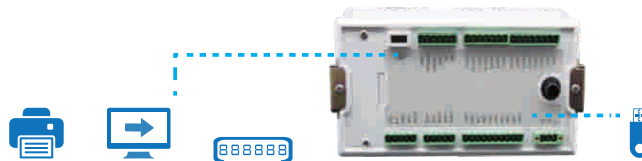

Application Diagram

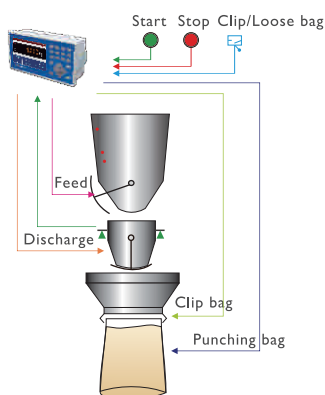

Single Channel Packaging Controller with Hopper

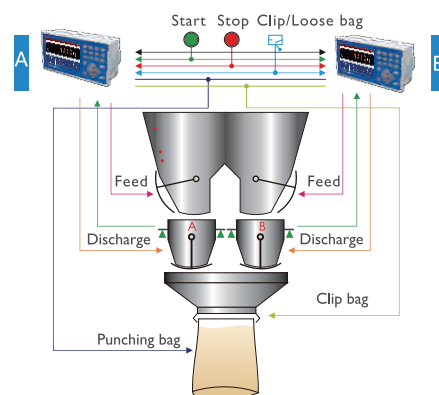

Double Channel Packaging Controller with Hopper

M04-D

Bagging Scale Controller with Double Hopper



M04-D software supports for multi-type bagging scale application (dual mode).



Version Features

MULTI-Mode

Supporting hopper / non-hopper mode, pneumatic and electric mode.

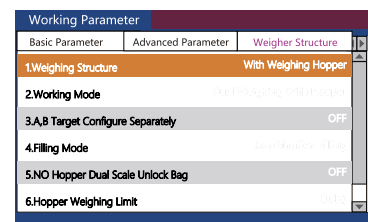
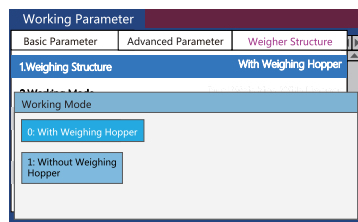

Supporting I/O tests, easy for products debugging.



Automatic three-material speed feeding control, with optional manual slow feeding function.



Multiple levels of operating permissions, such as users, administrators and system administrator.



Batch setting function, patting bags function, suitable for packaging powder materials



Feed control function, convenient for controlling the connection between packaging scale and feeding equipment.



Multiple digital filtering to improve the anti-interference capability of the packaging scale.

Button Functions

Shortcut key can be set to facilitate formulation selection, batch setting, parameter calibration and other operations.

System Info.	
USB Data Export	Shortcut Setting
1.Button 1	Working
2.Button 2	Calibration
3.Button 3	Batch
4.Button <-	Target
5.Button 4	System Info
6.Button 5	Recipe ID

Database

It can store 40 groups of recipes. For each formula can input target value, fast/slow feed, drop value and other parameters. Parameters can be entered manually or imported through USB interface.

Administrator	
1.Recipe	Indicator has 40 recipe memories from 01 to 40.
2.Working Parameters	Each recipe includes many parameters.
3.Peripherals	User can according set and edit this value.
4.Motor Parameter	
5.Calibration	Recipe ID
6.ACUM And Batch	02
7.I/O Module	Target
8.Serial Port	0.0kg
9.User Management	
10.System Info.	Button : 1-Choose Recipe

I/O Port

USB

For importing and exporting formula, working, I/O function, communication and other parameters, also for upgrading system/software, and customizing boot screen.

RS485+RS232

For connecting PC, PLC, printer, label printer, remote display, coding machine or other external equipment, which can be used for remote reading and setting.

I2 Input/I7 Output

For starting, and stopping, and carrying out A/B scale feeding, A/B scale unloading and other operations.



Application Diagram

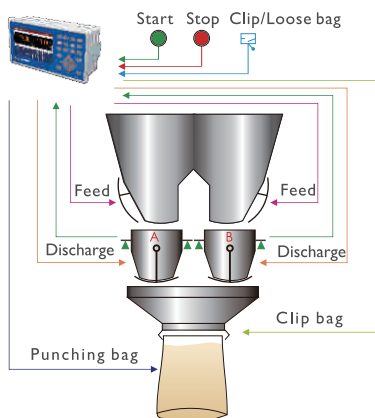

Double Channel Packaging Controller with Hopper

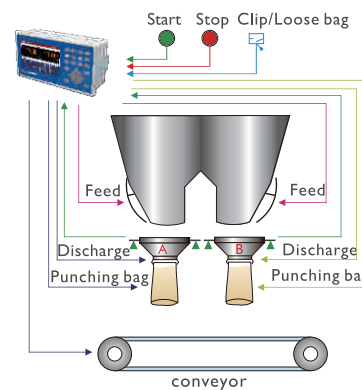

Double Channel Packaging Controller without Hopper

M04-5

Bulk Scale Controller



M04-5 software supports for continuous weighing bulk scale application to solve the problem of batch weight and automatic totalizing of incoming and outgoing materials.



Version Features

Updated Algorithm

Weighing control faster and more accurate ;
AD conversion rate 960times/sec;

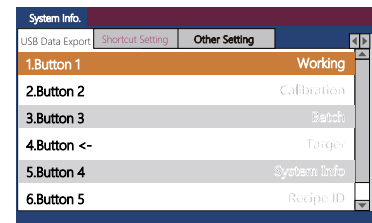
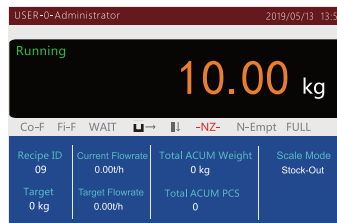

Supporting I/O tests, easy for products debugging.



Automatic three-material speed feeding control, with optional manual slow feeding function.



Multiple digital filtering to improve the anti-interference capability of the packaging scale.



Batch setting function.



Feeding control function facilitates the control connection between feeding equipment and discharging equipment.



Multiple levels of operating permissions, such as users, administrators and system administrator.

Button Functions

One-click button can be set for recipe selection, batch setting, parameter calibration, etc.

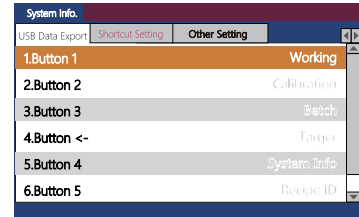
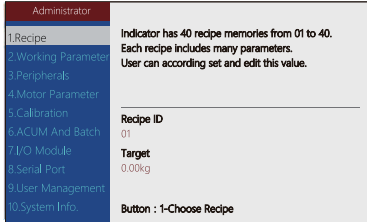

Database

It can store 20 groups of recipes. For each recipe, the target value, fast/slow feeding mode, drop value and other parameters can be set up manually.

I/O Port

8 Input/12 Output

Used to start and stop, and carry out A/B scale feeding, A/B scale unloading and other operations.

ModbusTCP

For connecting PC, PLC, Printers, etc. , for reading remotely.

RS485+RS232

For connecting PC, PLC, Printer, Label Printer, Remote Display, or other external devices, for reading and setup remotely.

USB

For importing and exporting recipes, works, I/O function, communication and other parameters, upgrading system software, customizing boot screen, etc.



Application Diagram

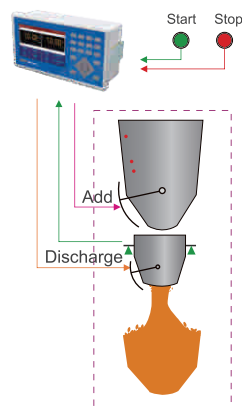

Continuous Weighing

M04-6/6D

Single/Double Nozzle for Liquid Filling Application



M04-6/6D software supports for single/double nozzle liquid filling application.



Version Features

M04-6/M04-6D

Selective single or double hopper filling scale: M04-6 or M04-6D

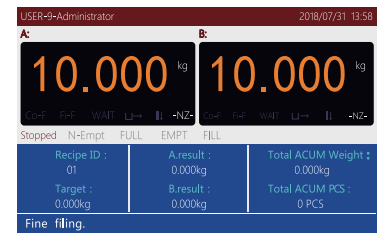
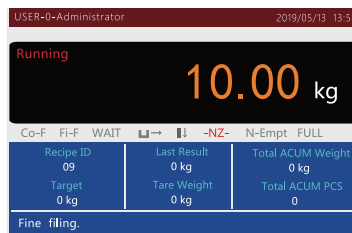

Supporting I/O tests, easy for products debugging.



Automatic two-material speed feeding control.



Multiple levels of operating permissions, such as users, administrators and system administrator.



Batch setting function.



Feeding control function facilitates the control connection between filling scale and frontend feeding equipment.



Multiple digital filtering to improve the anti-interference capability of the packaging scale.

Button Functions

Quick access key can be set to facilitate formulation selection, batch setting, parameter calibration and other operations.

Auxiliary logic programming function

Up to 6 sets of logic trigger signals can be defined, and simple logic signal output can be configured to control the upper barrel, gland, coding and other auxiliary devices.

Database

It can store 20 groups of recipes. For each formula can input target value, fast/slow feed, drop value and other parameters.

Intelligent feeding control

Automatic adjustment of fast feeding, slow feeding, filling scale speed and accuracy to achieve the best.

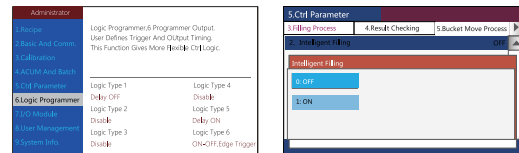

I/O Port

RS485+RS232

For connecting PC, PLC, printer, label printer, remote display, coding machine or other external equipment, which can be used for remote reading and setting.

USB

For importing and exporting formula, working, I/O function, communication and other parameters, also for upgrading system software, and customizing boot screen.

8 Input/12 Output

For starting, stopping, feeding, unloading, clamping/loosening, etc.



Application Diagram

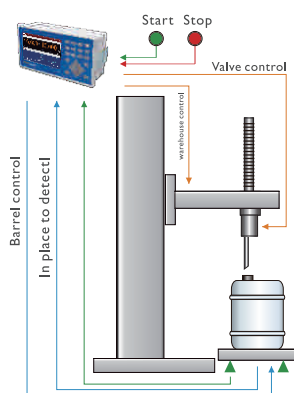

Single Nozzle for Liquid Filling Application

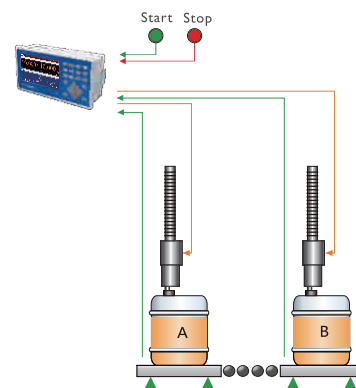

Double Nozzle for Liquid Filling Application

M04

Weighing Controller Stainless Steel Version



M04 weighing controller is designed for dynamic weighing applications like: packing, bulking, and liquid filling, widely used in grain and seeds, feeds, fertilizer, cement and concrete, and the chemical industries.

DESCRIPTION



Application Software

Multiple Software Selections:

- M04-2 Simplex packing;
- M04-D Duplex packing;
- M04-4 Reduce weight method packing;
- M04-5 Bulk Scale (continuous weighing);
- M04-6/6D Liquid filling(simplex/duplex);



Industrial Design

- Stainless steel case, robust and durable;
- 5-inch LCD screen plus button input, user-friendly operation;
- 20 species formula for different weight ranges and materials packing;



Multiple Communication Methods

- RS232 + RS232/RS485 selectable;
- 8 Input/12 Output for starting, stopping, zeroing, clamping/loosening bags, etc.;
- Modbus TCP for connecting PC, PLC, printer etc.;
- USB for importing and exporting data or working parameters, upgrading software or customizing boot screen.;



Standard Specification

General Specifications	Model	M04
	Power supply	DC 90~260V 50Hz(60Hz) $\pm 2\%$
	Working temperature	-10°C~40°C
	Maximum humidity	90% R.H without dew
	Testing standards	Class III 6000 e, 1 μ V/d
	IP grade	Ip65 (front panel)
A/D Conversion	A/D performance	24 bit Delta-Sigma
	A/D conversion speed	120/240/480/960 times/sec
	Non-linearity	0.01%F.S
	Gain drift	10PPM/°C
	Input sensitivity	0.02 μ V/d
	Display accuracy	1/100,000
	Input range	0.02~15mV
	Sensor power supply	DC5V 125mA(Max)
	Input impedance	10M Ω
Zero steady range	Maximum 0.002 ~ 15mV(Load Cell 3mV/V)	
Application Software	<ol style="list-style-type: none"> 1.M04-2 Simplex packing; 2.M04-D Duplex packing; 3.M04-4 Reduce weight method packing; 4.M04-5 Bulk scale (continuous weighing); 5. M04-6/6D Liquid filling(simplex/duplex); 	

Dimension

Unit:mm

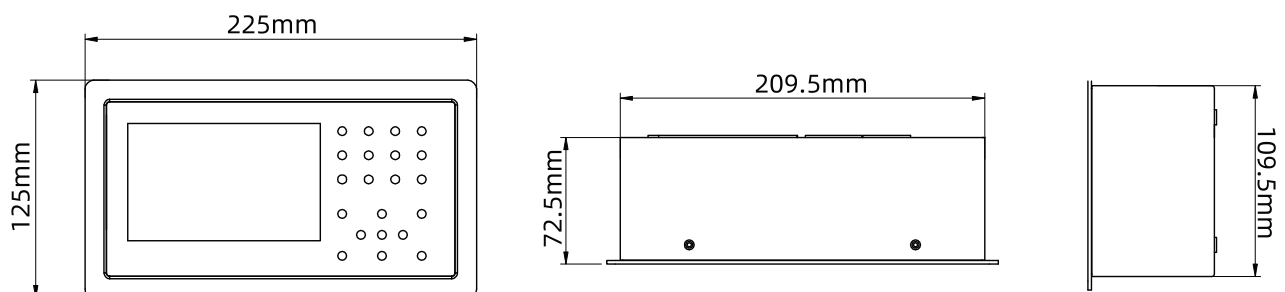

Application

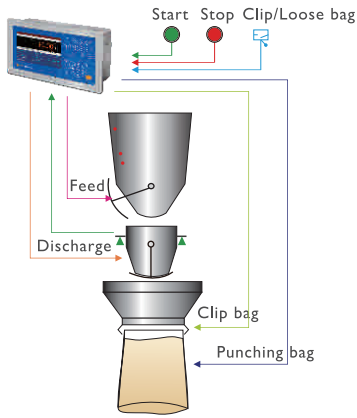

Single Channel Packaging Controller with Hopper

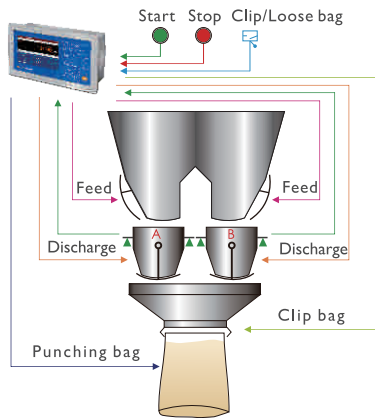

Double Channel Packaging Controller with Hopper

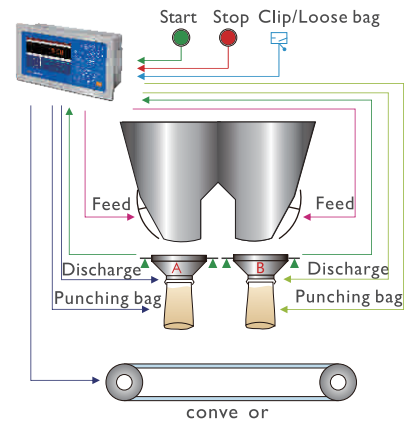

Double Channel Packaging Controller without Hopper

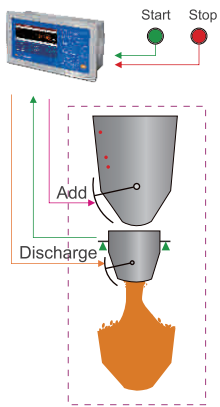

Continuous Weighing

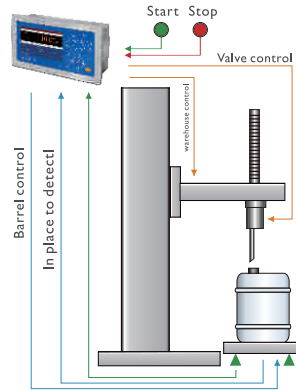

Single Nozzle for Liquid Filling Application

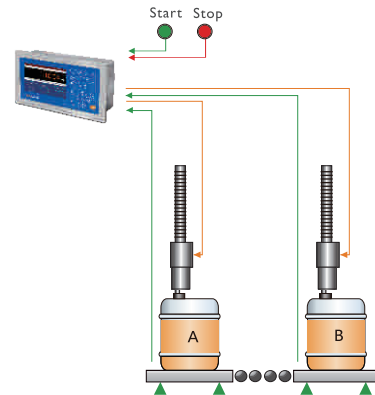

Double Nozzle for Liquid Filling Application



General Measure Technology Co.,Ltd.

Address: Room2208, Block A, Building 6, Shenzhen International Innovation Valley, Nanshan District, Shenzhen, Guangdong Province, P.R.China.

Tel/Wechat: +86 185 6585 5789

E-mail: xjlv@szgmt.com

Website: www.gmweighing.com



Linkedin



Facebook

GMC-P7

Touch Screen Weighing Controller



GMC-P7 weighing controller is designed for dynamic weighing/packing/batching applications, widely used in grain and seeds, feeds, rubber and plastic, and the chemical industries.



DESCRIPTION



Application Software

Multiple Software Selection:

- Simplex packing;
- Duplex packing;
- Reduce weight method packing;
- Bulk Scale (Continuous weighing);
- Batching scale.

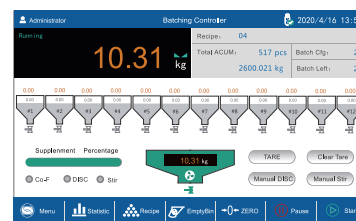
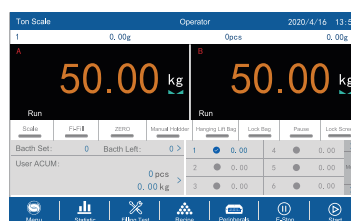

User-friendly Design

- 7-inch touch screen, interactive design, and easy operation;
- Record the weight of every pack, million data storage and export.



Multiple Communication Methods



- **RS232+RS485** for connecting PC, PLC, Printer, Label Printer, Remote Display, Code Printer, or other external devices, for reading and setup remotely;
- **12 Input/16 Output** for starting, stopping, unloading, clamping/loosening bags, etc.;
- **Modbus TCP** for connecting PC, PLC, Printer, etc., for reading remotely;
- **USB** for importing and exporting recipes, I/O function communication parameters and other working parameters, upgrading system software, customizing boot screen, etc.

Standard Specification

General Specifications	Model	GMC-P7 (CoPro Series)
	Power Supply	DC 24V plus or minus 5%
	Working temperature	-10°C~40°C
	Maximum humidity	90% R.H without dew
	Testing standards	Class III 6000 e, 1 μ V/d
	Power consumption	About 15 w
Measurement Parameters	A/D performance	24 bit Delta-Sigma
	A/D conversion speed	120/240/480 times/sec
	Non-linearity	0.01%F.S
	Gain drift	10PPM/°C
	Input sensitivity	0.02μV/d
	Display Accuracy	1/100,000
	Input range	0.02~15mV
	Sensor power supply	DC5V 125mA(Max)
	Input impedance	10MΩ
	Zero steady range	Maximum 0.002 ~ 15mV(Load Cell 3mV/V)
Application Software	<ul style="list-style-type: none"> • Simplex packing; • Reduce weight method packing; • Batching scale. 	<ul style="list-style-type: none"> • Duplex packing; • Bulk Scale (Continuous weighing);
Function extension	Equipped with GMA-X1 automatic traction module, reduce workforce cost	

Dimension

Unit:mm

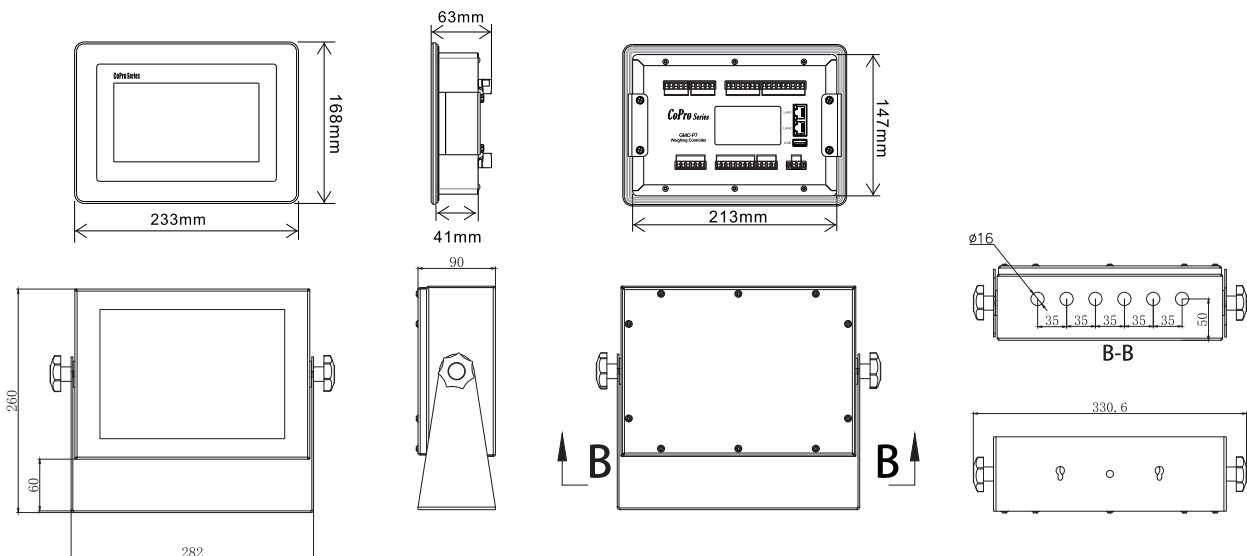

GMC-P7(F8)

Touch Screen Weighing Controller

(Digital Version Available)



GMC-P7(F8) is a high precision weighing controller with 7-inch touch screen. It is easy for operation and checking data. The new algorithm and optimized A/D conversion scheme make the weighing transmission faster and more accurate. A variety of optional communication interfaces make it easier to interact with data between various equipment systems. It can be used in harsh environment for the applications of platform scale, silo weighing, animal weighing, counting, and truck scale.



HARDWARE CONFIGURATION



Standard:

- 5 input (TTL), 9 output (5 TTL and 4 relay output), I/O position can be customized;
- 2 RS485 and 1 RS232;
- Modbus TCP;

Options:

- Profinet or Ethernet/IP;
- 1 analog output;

Digital Version

Standard:

- RS485+ RS232;
- 1 RS485 for digital loadcell interface;
- 5 inputs 5 outputs I/O;
- USB for software upgrading;

Options:

- Analog output;
- ModbusTCP or Ethernet/IP or Profinet;



FEATURES & FUNCTIONS

- 7-inch touch screen provides good interaction, easy for operation;
- Stainless steel casing, robust and anti-interference capability;
- I/O test function and serial test function for user-friendly debugging;
- Built-in web page, which can be connected by Modbus TCP for data interaction;
- Settable upper and lower weight values, which can be read through the communication interface;
- Editable boot screen;
- Static check weigher function;
- Counting function with adaptive adjustment of unit sampling weight;
- Support the connection of printers including Epson printers, while the head and tail of the printed information can be edited.

Standard Specification

	Model	GMC-P7 F8	GMC-P7 F8 Digital Version
General Specifications	Power Supply	DC 24V±5%	
	Working temperature	-10°C~40°C	
	Maximum humidity	90% RH.without dew	
	Testing standards	Class III 6000 e, 1μV/d	
	Power consumption	About 15W	
	Measurement Parameters	A/D performance	24 bit Delta-Sigma
A/D conversion speed		50~960 times/sec	N/A
Non-linearity		0.01%F.S	N/A
Gain drift		10PPM/°C	N/A
Input sensitivity		0.02μV/d	N/A
Input range		0.02~15mV	N/A
Display Accuracy		1/100,000	1/100,000
Sensor power supply		DC 5V 125mA(Max)	DC 12V 250mA
Input impedance		10MΩ	N/A
Zero steady range		Maximum 0.002 ~ 15mV (Load Cell 3mV/V)	N/A

Dimension

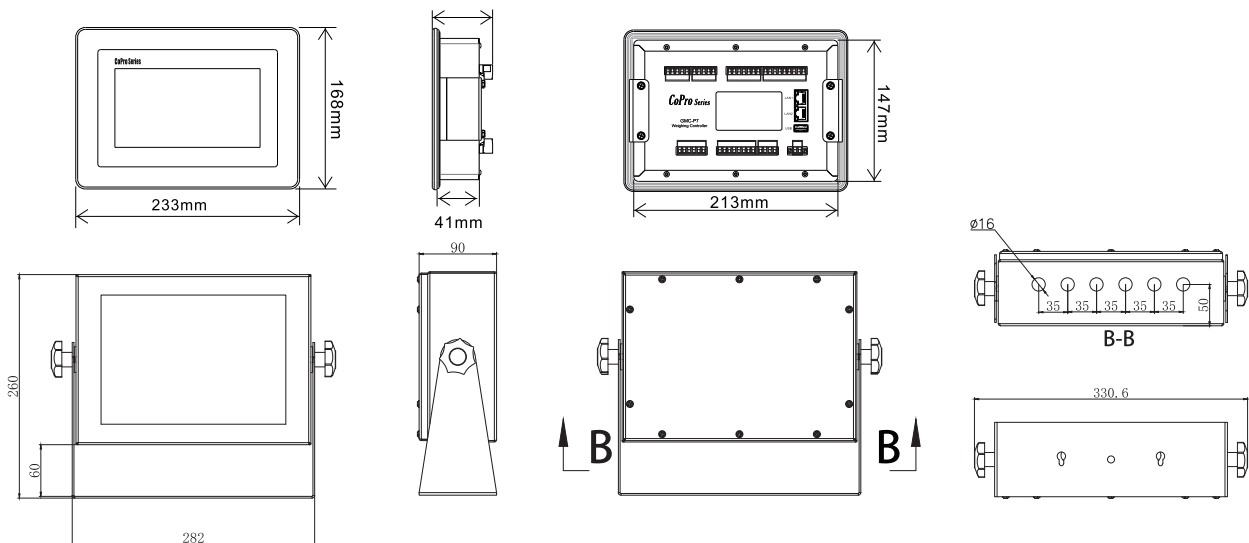

GM9907-L2/LD

Packing Controller
(L2:Simplex Packing LD:Duplex Packing)



GM9907-L2/LD is the simplex/duplex packing controller , widely used for, granule packing scale, powder packing scale,big bag, valve type scale-cement, etc.



Version Features

User-Friendly · Better Experience

- Memory card build in, 7-inch touch screen for displaying clearly and operating easily, Single/double scale interface mode switching;



- **L2:** Simplex packing; **LD:** Duplex packing; can be choosed, interface displayed accordingly;

- **Multi-Mode:** With Hopper, No Hopper, Big Bag Scale,Valve Scale,PLC;

- **Self-Adaptive:** I/O Programmable;

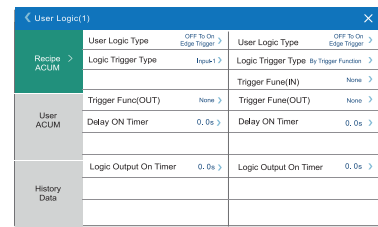
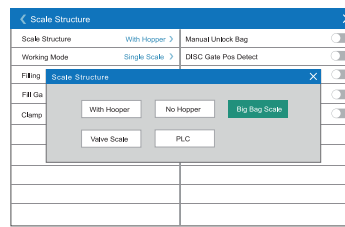
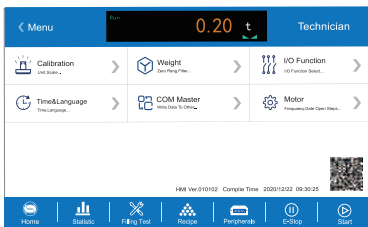

Communication

RS485+RS232

- For connecting PC,PLC,Printer,Label Printer, Remote Display,Code Printer,or other external devices,for reading and setup remotely;

USB

- For importing and exporting recipes,works,I/O function communication and other parameters, upgrading system software,customizing boot screen,etc;

12 Input/16 Output

- For starting,stopping, feeding, unloading, clamping/loosening bags,etc;

Modbus TCP

- For connecting PC, PLC, Printers,etc., for reading remotely.

Specification

Model		GM9907-L2/LD
General Specifications	Power Supply	DC24V
	Operating Temperature	-10~40 C
	Maximum Humidity	90%R.H without dew
	Test Standard	Class III 6000e,1μV/d
	Power Consume	About 15W
Measurement parameters	A/D converter type	24 bit Sigma-Delta
	A/D Conversion Rate	120/240/480/960 times /sec
	Non-Linear	0.01%F.S
	Gain Drifting	10PPM/C
	Minimum Sensitivity	0.02μV/d
	Analog Input Range	0.02~15mV
	Display Accuracy	1/100,000
	Power Source for Load Cell	DC5V 125mA(MAX)
	Input Resistance	10MΩ
	Zero Point Adjustment Range	0.002~15mV (load cell 3mV/V)
I/O Interfaces and Communications	12 Input 16 Output, I/O Selectable	
	12 Input, Active-low Start, Emergency stop, Stop, Zeroing, Clear alarm, Clear total ACUM, Bag Lock/Unlock, Manual discharge, Manual fine flow, Manual coarse flow, Change recipe, Empty material 16 Output, Single drive current 500mA Run, Stopped, Coarse flow, Medium flow, Fine flow, Bag lock, Result waiting, Ready, Discharge, -NZ-, Pat bag, FILL, EMPT, Alarm, Batch complete, Over/Under	

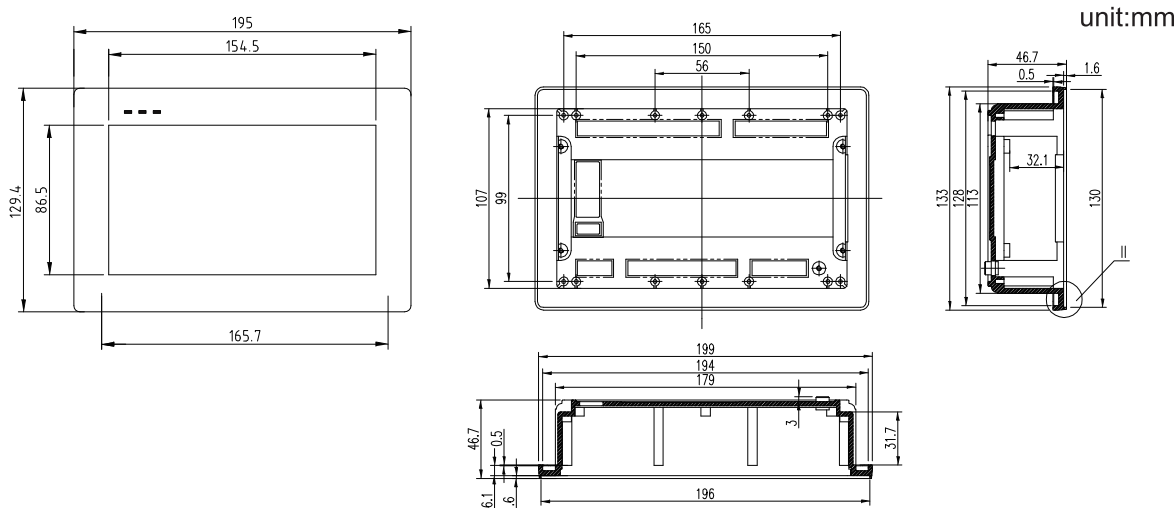

Application Diagram

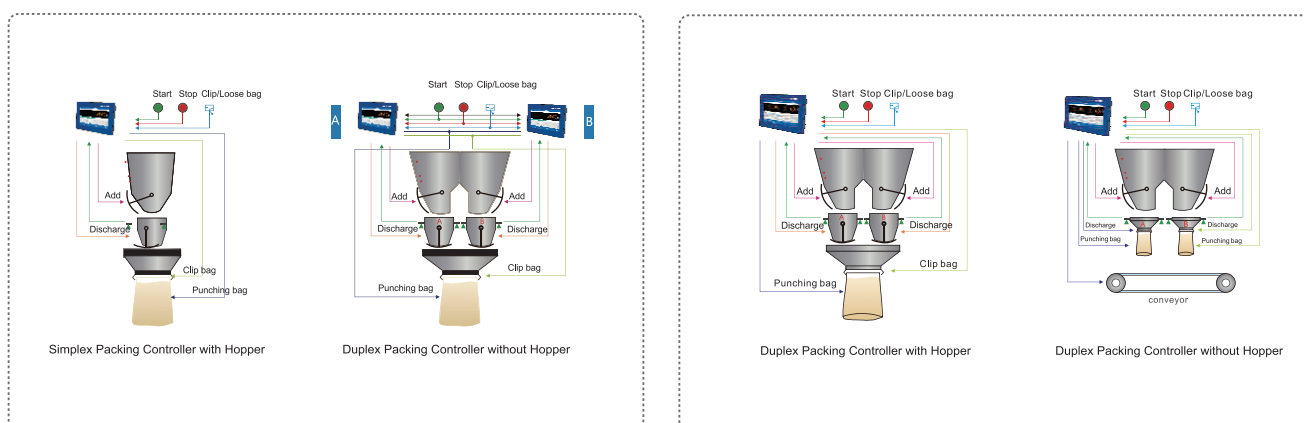

GM9907-L2

GM9907-LD

GM9907-L4

Reduce weight method packing controller



GM9907-L4 is designed for Loss-in-weight bagging machine. It can be widely used in rice, grains, feeds, chemical industries etc.



Version Features

User-Friendly · Better Experience

- Memory card build in, 7-inch touch screen for displaying clearly and operating easily;

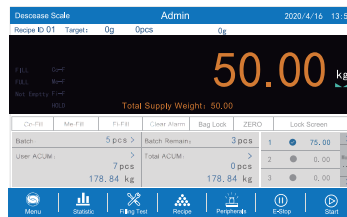

- It can store 20 groups of recipes, 9 groups of users accumulation data;



- Data backup and recovery function can save the optimal parameters and improve the working efficiency;

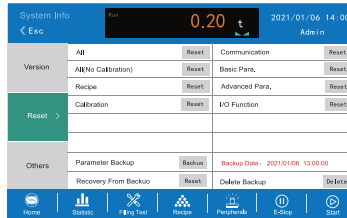

- Starting patting mode when filling material to shape bags by setting relevant parameter;

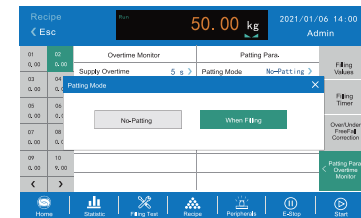

Communication

RS485+RS232

- For connecting PC,PLC,Printer,Label Printer, Remote Display,Code Printer,or other external devices,for reading and setup remotely;

USB

- For importing and exporting recipes,works,I/O function communication and other parameters, upgrading system software,customizing boot screen,etc;

12 Input / 16 Output

- For starting, stopping, feeding, unloading, clamping/loosening bags, etc;

Modbus TCP

- For connecting PC, PLC, Printers, etc., for reading remotely.

Specification

Model		GM9907-L4
General Specifications	Power Supply	DC24V
	Operating Temperature	-10~40 C
	Maximum Humidity	90%R.H without dew
	Test Standard	Class III 6000e,1μV/d
	Power Consume	About 15W
Measurement parameters	A/D converter type	24 bit Sigma-Delta
	A/D Conversion Rate	120/240/480/960 times / sec
	Non-Linear	0.01%F.S
	Gain Drifting	10PPM/ C
	Minimum Sensitivity	0.02μV/d
	Analog Input Range	0.02~15mV
	Display Accuracy	1/100,000
	Power Source for Load Cell	DC5V 125mA(MAX)
	Input Resistance	10MΩ
	Zero Point Adjustment Range	0.002~15mV (load cell 3mV/V)
I/O Interfaces and Communications	2 Input 16 Output, I/O Selectable	
	12 Input, Active-low Start, Emergency stop, Stop, Zeroing, Clear alarm, Change recipe, Bag Lock/Unlock, Manual discharge, Manual fine flow, Manual coarse flow, Clear total ACUM, etc.	
	16 Output, Single drive current 500mA Run, Stopped, Coarse flow, Medium flow, Fine flow, Bag lock, Result waiting, Pat bag, FILL, Batch complete, Supply full, Pause, etc.	

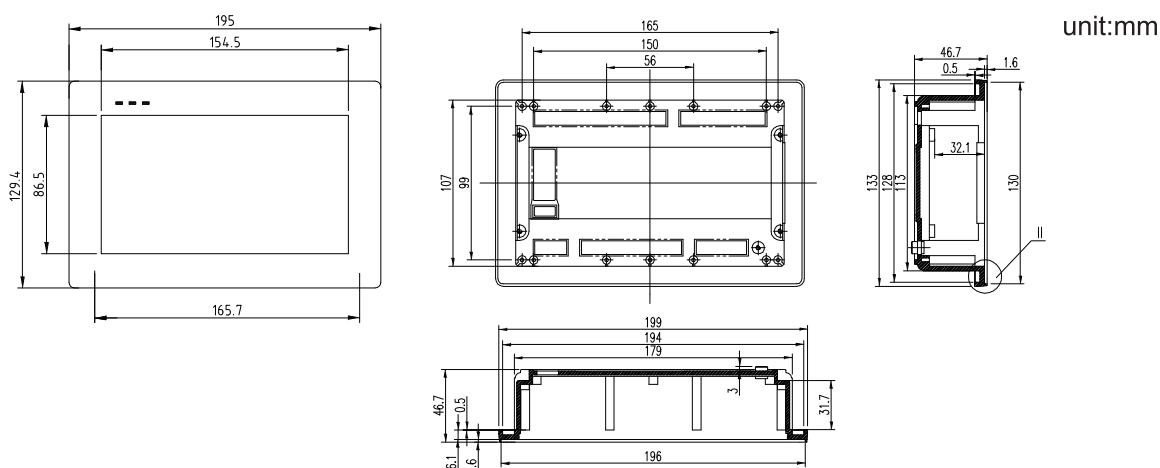

Application Diagram

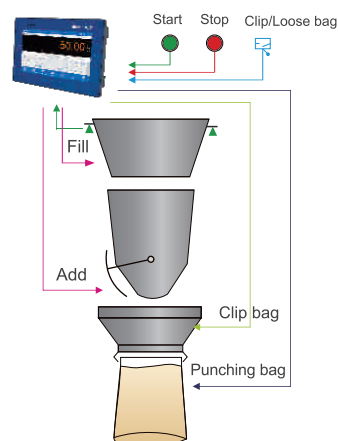

Reduce weight method packing

GM9907-L5

Bulk Scale Controller (Continuous Weighing)



GM9907-L5 is designed for bulk scale to solve the problem of batch weight and automatic totalizing of incoming and outgoing material. It can be used widely used in chemical, grain, feeds, construction and harbor logistics industries etc.



Version Features

User-Friendly · Better Experience

- Memory card build in, 7-inch touch screen for displaying clearly and operating easily;

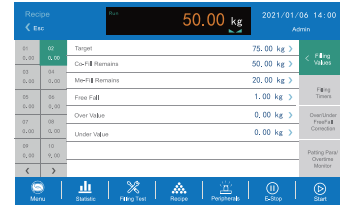
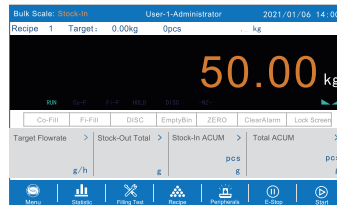

- Flow rate function can discharge material automatically and alarm when flow rate is low, which is more intelligent;



- Two scale mode: Stock-In or Stock-Out; Data information is more convenient to operate;

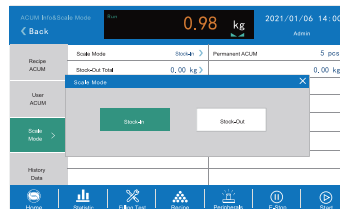

- Two packing mode: Motor or Pneumatic; Add/Discharge feed is more convenient;

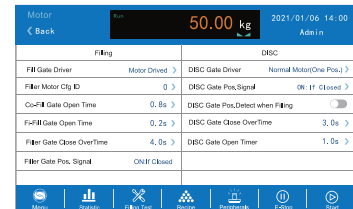

Communication

RS485+RS232

- For connecting PC, PLC, Printer, Label Printer, Remote Display, Code Printer, or other external devices, for reading and setup remotely;

USB

- For importing and exporting recipes, works, I/O function communication and other parameters, upgrading system software, customizing boot screen, etc;

12 Input / 16 Output

- For starting, stopping, feeding, unloading, clamping/loosening bags, etc;

Modbus TCP

- For connecting PC, PLC, Printers, etc., for reading remotely.

Specification

Model		GM9907-L5
General Specifications	Power Supply	DC24V
	Operating Temperature	-10~40 C
	Maximum Humidity	90%R.H without dew
	Test Standard	Class III 6000e,1μV/d
	Power Consume	About 15W
Measurement parameters	A/D converter type	24 bit Sigma-Delta
	A/D Conversion Rate	120/240/480/960 times / sec
	Non-Linear	0.01%F.S
	Gain Drifting	10PPM/ C
	Minimum Sensitivity	0.02μV/d
	Analog Input Range	0.02~15mV
	Display Accuracy	1/100,000
	Power Source for Load Cell	DC5V 125mA(MAX)
	Input Resistance	10MΩ
	Zero Point Adjustment Range	0.002~15mV (load cell 3mV/V)
I/O Interfaces and Communications	12 Input 16 Output, I/O Selectable	
	12 Input, Active-low Start, Emergency stop, Stop, Zeroing, Clear alarm, Fill permission, Clogged, Manual fine flow, etc.	
	16 Output, Single drive current 500mA Run, Stopped, Clogged, Coarse flow, Fine flow, Result waiting, Over/under, Alarm, Stock-out Done, Last feed, DISC, -NZ-, etc.	

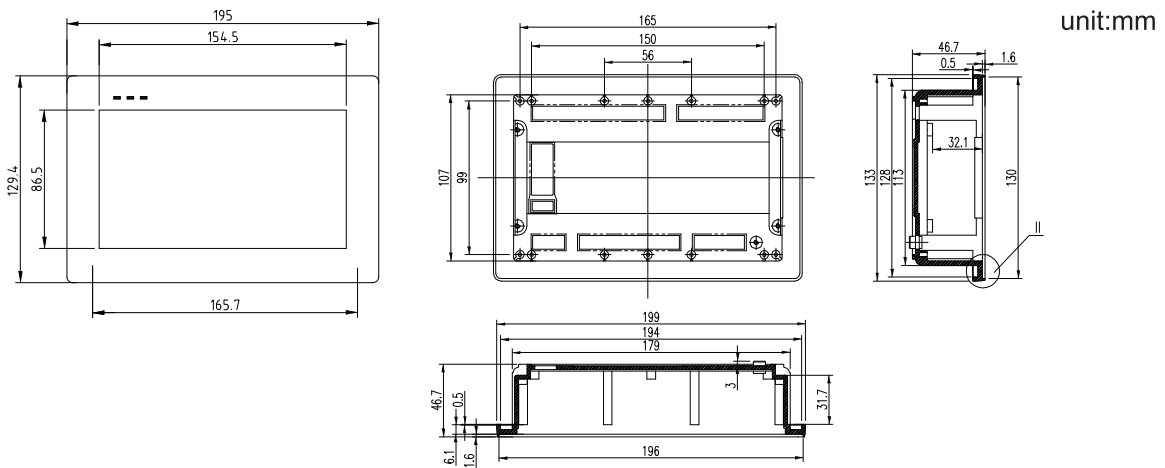

Application Diagram

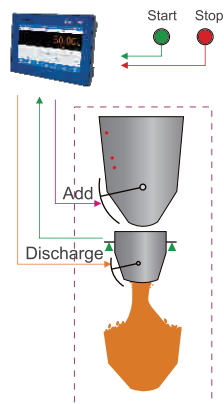

Continuous Weighing

GM9907-L6/L6D

Liquid Filling Controller



GM9907-L6/L6D is designed for single/double nozzle liquid filling applications. It can widely used in food&beverage, chemical, coating industries and so on.



Version Features

User-Friendly · Better Experience

- Memory card build in, 7-inch touch screen for displaying clearly and operating easily;

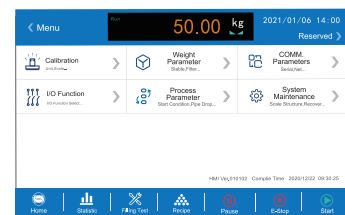
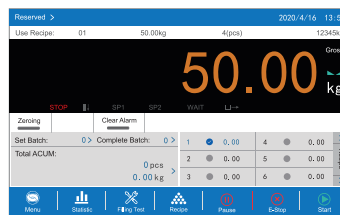

- L6/L6D single or double nozzle liquid filling applications can be chosen. UI changed accordingly.

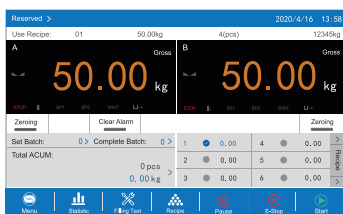

- It can store 20 pieces of formulation for different materials filling.

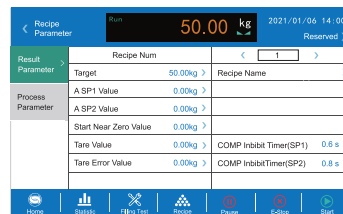

- Automatic 2-filling speed, feed control function, easy to connect with front-end equipment.

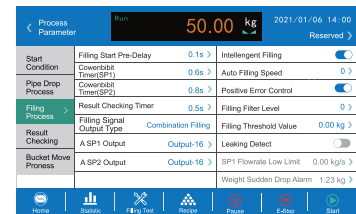

Communication

RS485+RS232

- For connecting PC,PLC,Printer,Label Printer, Remote Display,Code Printer,or other external devices,for reading and setup remotely;

USB

- For importing and exporting recipes,works,I/O function communication and other parameters, upgrading system software,customizing boot screen,etc;

12 Input / 16 Output

- I/O programmable.

Modbus TCP

- For connecting PC, PLC, Printers, etc., for reading remotely.

Specification

Model		GM9907-L6/L6D
General Specifications	Power Supply	DC24V
	Operating Temperature	-10~40 C
	Maximum Humidity	90%R.H without dew
	Test Standard	Class III 6000e,1μV/d
	Power Consume	About 15W
Measurement parameters	A/D converter type	24 bit Sigma-Delta
	A/D Conversion Rate	120/240/480/960 times / sec
	Non-Linear	0.01%F.S
	Gain Drifting	10PPM/ C
	Minimum Sensitivity	0.02μV/d
	Analog Input Range	0.02~15mV
	Display Accuracy	1/100,000
	Power Source for Load Cell	DC5V 125mA(MAX)
	Input Resistance	10MΩ
	Zero Point Adjustment Range	0.002~15mV (load cell 3mV/V)
I/O Interfaces and Communications	12 Input, Active-low Start, Emergency stop, Zeroing, Clear alarm, Switch formula, Dropping/lifting nozzle, feeding, etc	
	16 Output, single drive current 500mA Run, Stop, Fast feeding, Slow feeding, Constant value, Over/Under weight, Alarm, Move barrel, dropping nozzle, Batching finish, etc.	

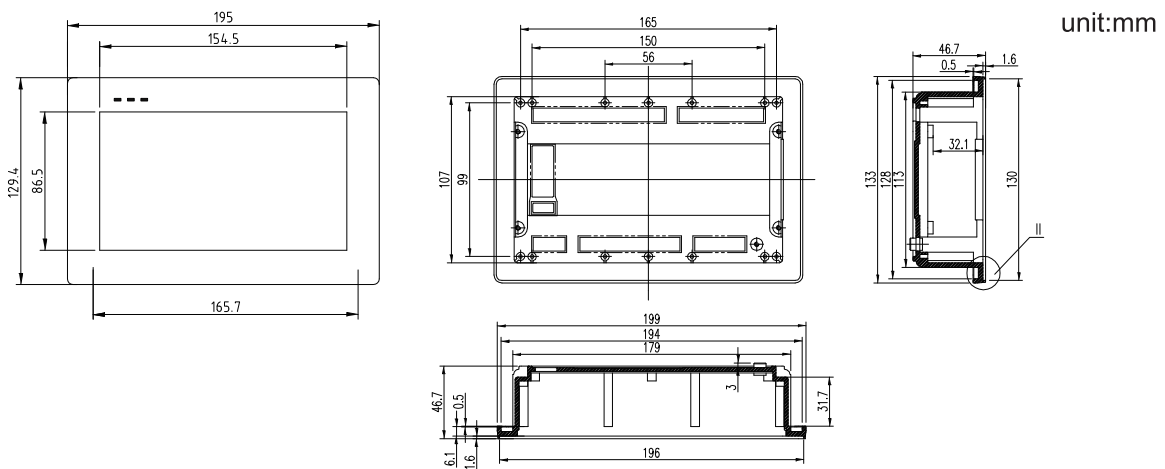

Application Diagram

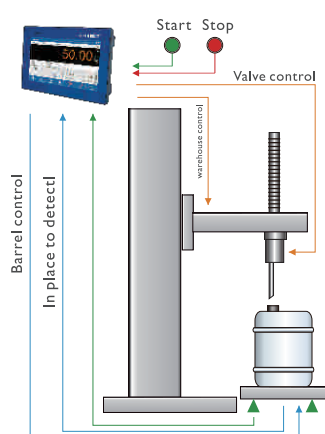

Single Nozzle for Liquid Filling Application

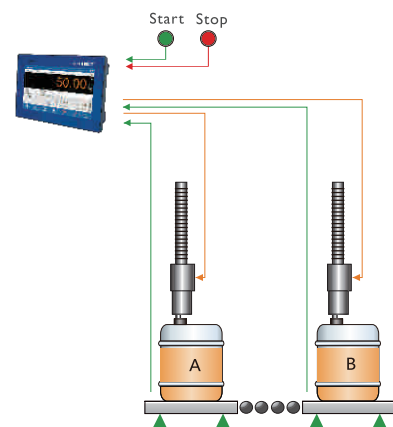

Double Nozzle for Liquid Filling Application

GM9907-LB

Batching Scale Controller



GM9907-LB is designed for batching scale that can sort feeding orders of a variety of materials. It can be widely used in concrete mixing, bituminous mixing, metallurgy, chemical, feeds industries etc.



Version Features

User-Friendly · Better Experience

- Memory card build in, Dynamic batching process can be graphically displayed for better understanding and monitoring;

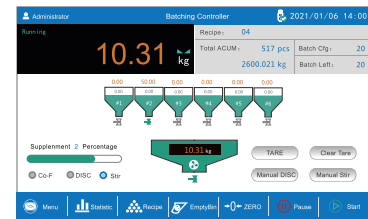
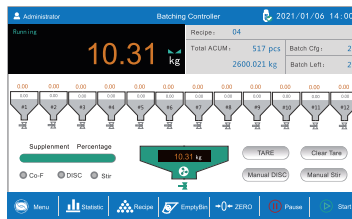

- Support the batching of 12 kinds of materials. It can be customized according to the batching process sequence, which is flexible to use;

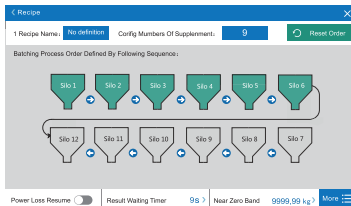

- The working process is clear. Feeding value and time of the material can be set, and real-time feeding dynamic can be displayed;

Recipe1	Supplement2	Filling PreDelay Timer	.5s >
Target		COMP.Inhibit Timer(Co-F)	.5s >
Co-Fill Ramin		COMP.Inhibit Timer(Me-F)	.5s >
Me-Fill Ramin		COMP.Inhibit Timer(F-F)	.5s >
Free Fall		Stir Control	.5s >
Over Limit Value			
Under Limit Value			
Fill Pause Control			<input type="checkbox"/>

- User-friendly design: Save function when power down and monitoring alarm function;

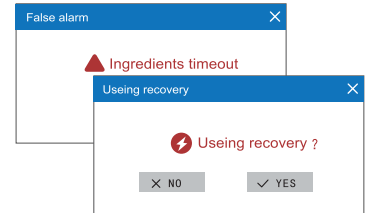

Communication

RS485+RS232

- For connecting PC,PLC,Printer,Label Printer, Remote Display,Code Printer,or other external devices,for reading and setup remotely;

USB

- For importing and exporting recipes,works,I/O function communication and other parameters, upgrading system software,customizing boot screen,etc;

12 Input/16 Output

- For starting, stopping, feeding, unloading, clamping/loosening bags, etc;

Modbus TCP

- For connecting PC, PLC, Printers, etc., for reading remotely.

Specification

Model		GM9907-LB
General Specifications	Power Supply	DC24V
	Operating Temperature	-10~40 C
	Maximum Humidity	90%R.H without dew
	Test Standard	Class III 6000e,1μV/d
	Power Consume	About 15W
Measurement parameters	A/D converter type	24 bit Sigma-Delta
	A/D Conversion Rate	120/240/480/960 times /sec
	Non-Linear	0.01%F.S
	Gain Drifting	10PPM/ C
	Minimum Sensitivity	0.02μV/d
	Analog Input Range	0.02~15mV
	Display Accuracy	1/100,000
	Power Source for Load Cell	DC5V 125mA(MAX)
	Input Resistance	10MΩ
	Zero Point Adjustment Range	0.002~15mV (load cell 3mV/V)
I/O Interfaces and Communications	12 Input 16 Output, I/O Selectable	
	12 Input, Active-low Start, Emergency stop, Stop, Pause, ZERO, Clear alarm, Change recipe, M-DISC permission, TARE, Clear tare, Manual stir, etc.	
		16 Output, Single drive current 500mA Run, Stopped, Coarse flow, Medium flow, Fine flow, Result waiting, Over/under, DISC, -NZ-, Alarm, Stir, etc.

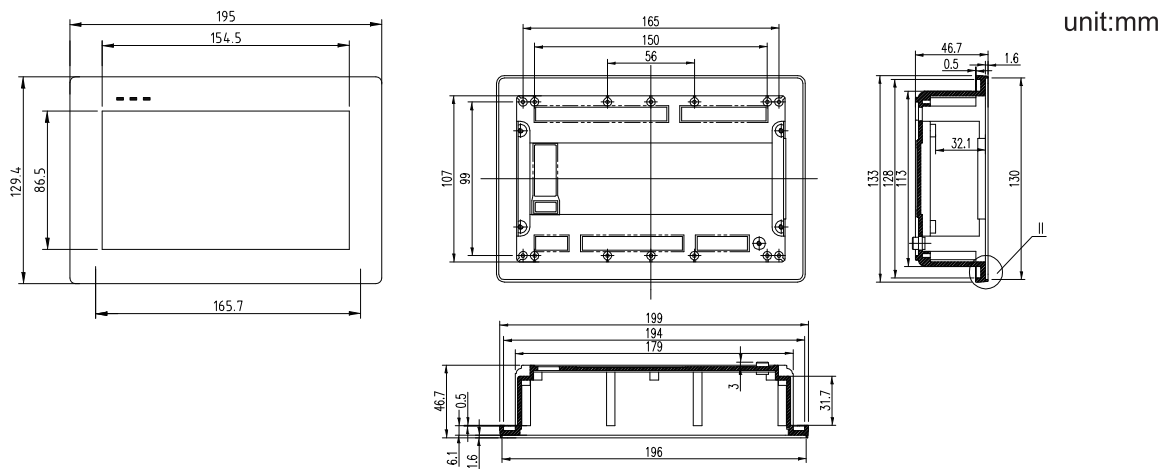

Application Diagram

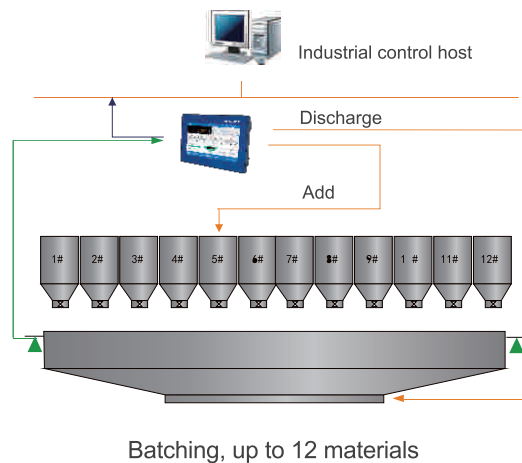

Highly Visible Remote Display



Remote display is a outdoor truck scale weight display of highest quality with full stainless steel body with IP65 standard, which is the ultra light LED display with wide viewing angle of 170 degrees and crystal clear under sunlight.



Remote Display GM8892



High Clarity LED Remote Display for Truck Scales



Remote Display GM8895



High Clarity LED Remote Display for Truck Scales



Communication

Our remote display offer unmatched flexibility with smart data recognition system compatible with indicators for truck scales, such as [AD-4321](#), [AD-4323](#), [TOLEDO](#), [Fairbanks](#), [R2500](#), [UMC600](#), [GSE50 serial](#), [Rinstrum](#), [WI-125](#), [WI-127](#), [Df1500](#) etc.



Standard Specification

Model	GM8892	GM8895
INDICATOR POWER		
Power Supply	90V ~ 260V AC 50Hz(or 60Hz)±2%	90V ~ 260V AC 50Hz(or 60Hz)±2%
Power Consume	20W	40W
DISPLAY		
Display	6 digits, 7 segments, Ultra bright LED	6 digits, 7 segments, Ultra bright LED
Digits Size	2.5"	5.0"
LED Indicators	3 LED, Gross, Net, Motion	3 LED, Gross, Net, Motion
Visible angle	10 degree to 170 degree	10 degree to 170 degree
ENVIRONMENTAL		
Operating Temperature	-10°C to 40°C	-10°C to 40°C
Storage Temperature	-25°C to 70°C	-25°C to 70°C
Humidity	90% R.H without dew	90% R.H without dew
IP Level	IP65	IP65
MECHANICAL DATA		
Dimensions with sun shelter	582×228×200 (L×W×H)	905×295×258 (L×W×H)
Dimensions without sun shelter	578×226×76 (L×W×H)	900×280×107 (L×W×H)
Weight	Approx. 8kgs	Approx. 16kgs
Certification	CE	CE
Enclosure	stainless steel	stainless steel
COMMUNICATION		
Interface	RS485/RS232; Current Circle; Wireless(Optional)	
INDICATOR SUPPORTED		
AD-4321, AD-4323, TOLEDO&Fairbanks, R2500, UMC600, GSE50 serial, Rinstrum, WI-125, WI-127, DF1500		

Dimensions

Unit:mm

GM8892

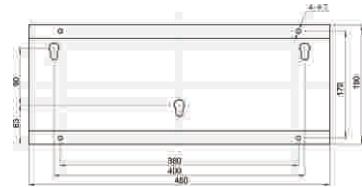
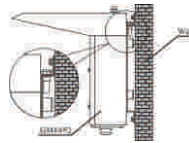
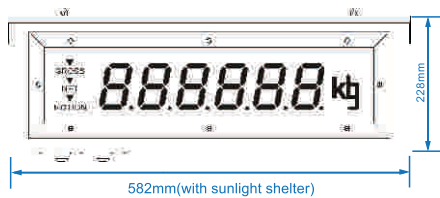

GM8895

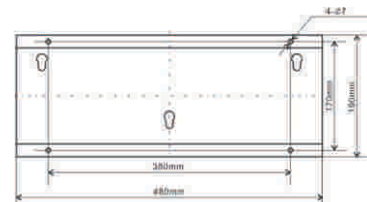
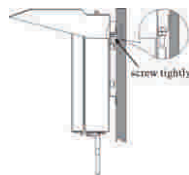
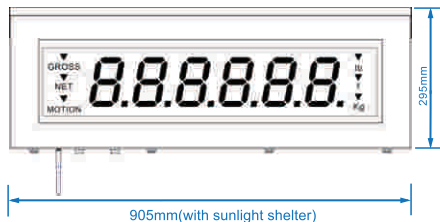

GM-JX-M

GM Load Cell Junction Box



GM-JX-M is a four-wire load cell junction box. In addition to regulating the wiring function, it can compensate and correct the four angle deviation by adjusting the resistance value of the precision potentiometer. In some special weighing occasions when the angle deviation is so large to affect the measurement results, this junction box can effectively solve the user's problems.



OPERATING INSTRUCTION



Internal terminal identification

Four-wire Connection Method .

Internal wire terminals are identified as follows:

- "+E"-- EXCITATION +
- "+S"-- SIGNAL +
- "GND"-- SHIELD
- "-E" -- EXCITATION -
- "-S "-- SIGNAL -

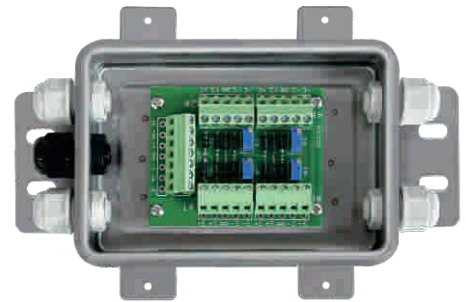

Adjustment Method

Precision potentiometer **W1~W4** can fine tune the output signal of each load cell, which is used to adjust the four angle deviation of the system.



Four-Angle Deviation Adjustment Method

- **Step 1:** Before adjustment, the four-channel potentiometer is gently rotated to the middle position;
- **Step 2:** Fine-tune the channel with large deviation to the average value (close the other three channels when observing one channel);
- **Step 3:** Repeat step 2 until the millivolt signals of four-channel are similar.

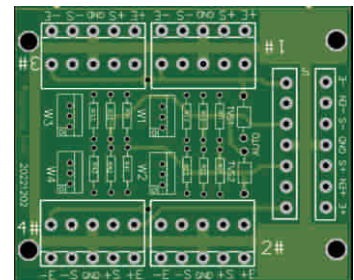

Dimensions

Unit:mm

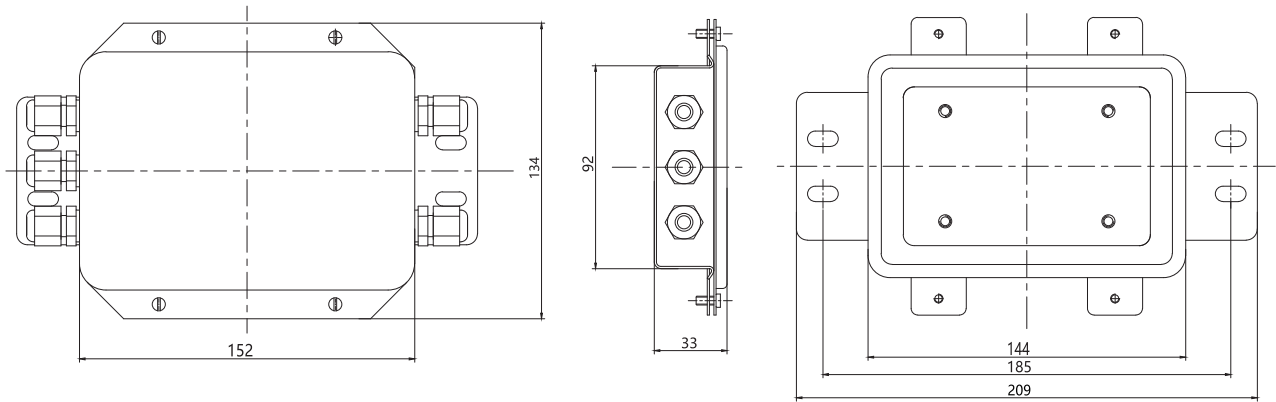

Connection Diagram

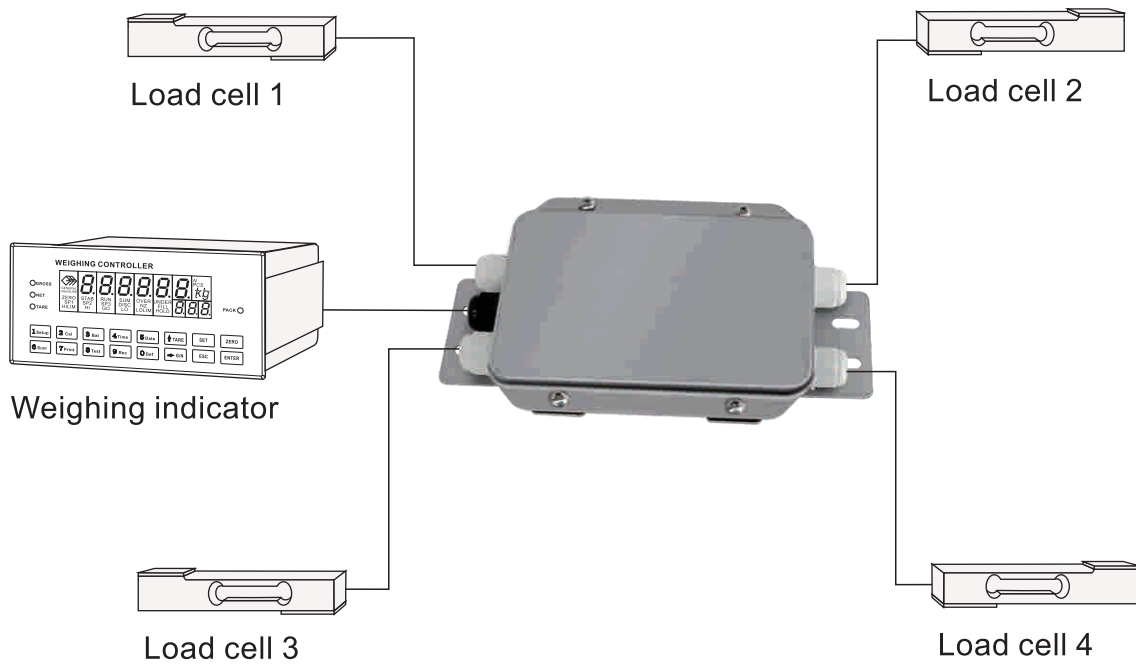

Making weighing more accessible.



Global Clients **2000+**



Product Cases



Multi-applications

GM products are widely used in lithium battery, concrete batching, foods, feeds, chemicals, pharmaceutical industries and etc.





[Linkedin](#)



[Facebook](#)



[Wechat](#)



General Measure Technology Co.,Ltd.

Address: Room2208, Block A, Building 6, Shenzhen International Innovation Valley,
Nanshan District, Shenzhen, Guangdong Province, P.R.China.

Tel/Wechat: +86 185 6585 5789

E-mail: xjlv@szgmt.com

Website: www.gmweighing.com