



杰 · 曼 · 科 · 技

GMT-X1

User Manual

110611020007

V01.10.25

Copyright © Shenzhen General Measure Technology Co., Ltd. All Rights Reserved.
Without the permission of Shenzhen General Measure Technology Co., Ltd. no unit or individual shall copy, transmit, transcribe or translate into other languages in any form or by any means.



Warning

The transmitter uses DC24V power supply, use AC220V power will cause permanent damage to the transmitter.

Please keep the transmitter well grounded.

The transmitter is electrostatic sensitive equipment, please pay attention to take anti-static measures in the use and maintenance

**Standard
&
Certification**

Product Standard: GB/T 7724—2008

Verification Regulation: JJG 649-2016

CMC Accuracy Class 3 (6000e)

Safety Certificate: CE

Content

1. General Description.....	- 1 -
1.1 Functions and Characteristics.....	- 1 -
1.2 Technical Specifications	- 1 -
2 Panels and buttons.....	- 2 -
2.1 Front Panel Description.....	- 2 -
2.2 Key sepcification	- 2 -
3 Installation and Wiring	- 4 -
3.1 Connection of Power Supply.....	- 4 -
3.2 Connection of Load Cell	- 4 -
3.3 Connection of I/O Terminal.....	- 5 -
3.4 Connection of Analog.....	- 6 -
3.5 Serial Port Output.....	- 7 -
3.5.1 Serial port fault troubleshooting.....	- 8 -
3.6 NetCom Connection	- 8 -
3.6.1 NetCom fault troubleshooting	- 8 -
3.7 CAN Connection	- 8 -
3.8 PROFIBUS bus Connection	- 9 -
4 Menu Review	- 10 -
4.1 Parameter option and setting	- 10 -
5. Basic Cfg parameter	- 12 -
5.1 Content	- 12 -
5.2 Zero Cfg	- 13 -
5.3 Tare function.....	- 13 -
6. Weight Format.....	- 14 -
6.1 Weight Format	- 14 -
6.2 CAL Zero	- 15 -
6.3 CAL Weight.....	- 16 -
6.4 Theory CAL	- 16 -
6.5 Calibration lock application	- 17 -
7.Application setting	- 18 -
7.1 Input Cfg	- 18 -
7.2 Output Cfg.....	- 19 -
7.3 Application	- 20 -
7.4 Application Example	- 21 -
8. Data-Trans.....	- 22 -
8.1 Serial port parameters.....	- 22 -
8.2 NetCOM parameters	- 23 -
8.2.1 Parameters description	- 23 -
8.2.2 Built-in web -Weasy device management system	- 24 -
8.3 Analog Parameters.....	- 25 -
8.4 Print Edit	- 25 -
8.5 Bluetooth communication	- 26 -
8.6 CAN communication.....	- 26 -

9. Maintenance	- 27 -
9.1 Parameter Specification.....	- 27 -
9.2 IO Test	- 28 -
9.3 Serial Port Test	- 29 -
9.4 Analog CAL	- 29 -
10. Communication protocol and address	- 31 -
10.1 Modbus protocol	- 31 -
10.1.1 Function code and and exception code description	- 31 -
10.1.2 Communication Mode.....	- 31 -
10.1.3 Modbus communication data sheet	- 31 -
10.2 Continuous send A (CB920)	- 40 -
10.3 Cont-B (Continuous send -tt)	- 40 -
10.4 r-Cont	- 41 -
10.5 rE-Cont.....	- 42 -
10.6 YH Protocol.....	- 42 -
10.7 PROFINET Protocol	- 42 -
10.7.1 IO state	- 42 -
10.7.2 Device description file GSD.....	- 47 -
10.8 EtherNet-IP Protocol	- 47 -
10.8.1 IO state	- 47 -
10.8.2 Device description file EDS	- 52 -
10.9 CAN OPEN Protocol	- 52 -
10.9.1 Standard frame active report data format	- 53 -
10.9.2 Standard frame read data format	- 53 -
10.9.3 Standard frame write in data format.....	- 54 -
10.10 DP communication	- 54 -
10.10.1 Bus settings	- 54 -
10.10.2 Simplified version of loop parameter address	- 55 -
10.10.3 Non cyclic parameter.....	- 56 -
10.10.4 Device description file GSD.....	- 56 -
10.11 CCLINK IE Communication.....	- 56 -
10.11.1 Cycle parameter address	- 56 -
10.11.2 Non cyclic parameter.....	- 58 -
10.11.3 Device description file CSP.....	- 58 -
10.12 EtherCAT communication	- 58 -
10.12.1 Bus Cfg.....	- 58 -
10.12.3 Non cyclic parameter.....	- 60 -
10.12.4 Device description file ESI.....	- 60 -
11. DIMENSION.....	- 61 -

1. General Description

1.1 Functions and Characteristics

Shell type	DIN Rail mounted, stainless steel housing		
load cell interface	1 way 6 wire analog load cell weighing platform interface, connection only 8 350 Ω load cells at most		
Display	128*32 0.91"white light OLED		
Language	Support Chinese,English		
Preset point function	8 - way comparator 11 comparison options		
Interface	1 way RS232/RS485 interface		
	1 way RS485 interface		
	Support 5.0 blue tooth module connet with smartphone App		
	Option 1	3 in 5 out Transistor I/O interface	
		3 in 4 out Relay output interface	
	Option 2	1 way 485+1 DA output	
		2 in 4 out Transistor I/O interface	
		1 CAN communication interface	
	Option 3	Double network port, built-in switch	
		Single network port	
		Profinet Bus interface	
		Ethernet/IP Bus interface	
		Profibus-DP Bus interface	
CCLink-IE Bus interface			
EtherCAT Bus interface			

1.2 Technical Specifications

Power supply	24VDC (18~30VDC)
Dimension	131*111.4*32 (mm)
GW	500g
Certified working environment	-10 ~ 40°C; 90% R.H without dew
Working environment	-20 ~ 60°C; 90% R.H without dew
Storage environment	-40 ~ 60°C; 90% R.H without dew
Power	5W
Load cell excitation voltage	5V 200mA (MAX)
Load cell requirements	A simulated Load cell, connection only 8 350 Ω load cells, most support 1 mv/V, 2 mv/V, 3 mv/V sensitivity
Input sensitivity	0.1uV/d
Non-linearity	0.01% F.S
A/D conversion speed	50; 60; 100; 120; 200; 240; 400; 480; 800; 960 (SPS)
Display Precision	1/999999
Keyboard	6 key sound keyboard
Decimal Places	0, 0.0, 0.00, 0.000, 0.0000; 5 options
Overload	OFL

2 Panels and buttons

2.1 Front Panel Description

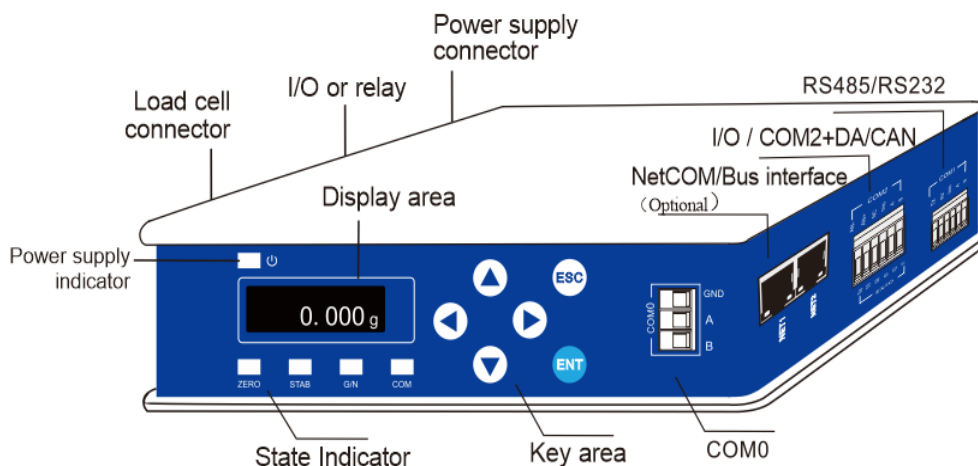



Status :





- : power, lights up when indicator is power on
- **ZERO**: Light on when material weight is $0 \pm 1/4d$.
- **STAB**: Light on when material weight is within stable range.
- **G/N**: Gross weight/Net weight, indicator flashes when the current display is new weight.
- **COM**: Light on when in communication status.

Item 576x (Maintenance) defines which port status the COM indicator light indicates. Definition range: COM 0, COM 1, COM 2, NetCom, CAN

2.2 Key specification

GMT-X1 has 6 button functions, short press and long press have differences, button diagram is shown as below:

Key	Interface	Short press	Long press
	Main interface	Switch display: Weight/Flowrate/Analog	Switch display: Weight/Loadcell Input
	Menu interface	Previous SubParameter	/
	Data input	Data or letter +1	Switch Capital
	Option select page	Previous SubParameter	/
	Main interface	Tare	Gross/Net weight display switch
	Menu interface	Next SubParameter	/
	Data input	Data or letter -1	Clear data to 0 when inputting pure numbers
	Menu interface	Next SubParameter	/
	Main interface	Check Tare value	Shortcut to preset tare value

	Menu interface	Next SubParameter	/
	Data input	Input position move to left	/
	Option select	/	/
	Main interfce	Print	Print empty line: Keep moving if it works until it is released
	Menu interface	Right Parameter Menu	/
	Data input	Input position move to right	/
	Option select	/	/
	Main interfce	Menu page	Quickly view software version and compilation date
	Menu page	Comfirm Selection	/
	Data input	Comfirm Selection	/
	Option select	Comfirm Selection	/
	Main interfce	Zero(If Gross)/Clear Tare(If Net)	Fast Calibrate Zero (If Gross)
	Menu page	Return to previous level	/
	Data input	Exit Page	/
	Option select	Back to Main interfce	/

3 Installation and Wiring

3.1 Connection of Power Supply

GMT-X1 weighing transmitter connects with DC24V power supply as follows.

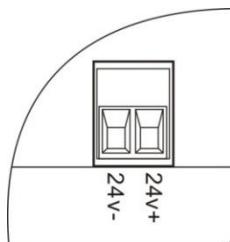

NOTE: The transmitter uses DC24V power supply, use AC220V power will cause permanent damage to the transmitter.

3.2 Connection of Load Cell

GMT-X1 weighing transmitter connects with bridge type resistance strain gauge load cells.

PORTS	EX+	SN+	EX-	SN-	SIG+	SIG-	SHL
6 wires	EX+	SN+	EX-	SN-	SIG+	SIG-	SHL
4 wires	EX+		EX-		SIG+	SIG-	SHL

※When connected to a 4-wire load cell, the EX+ and SN+ ports, EX- and SN- ports must be short-connected. Otherwise, the transmitter weight data reading is not normal.

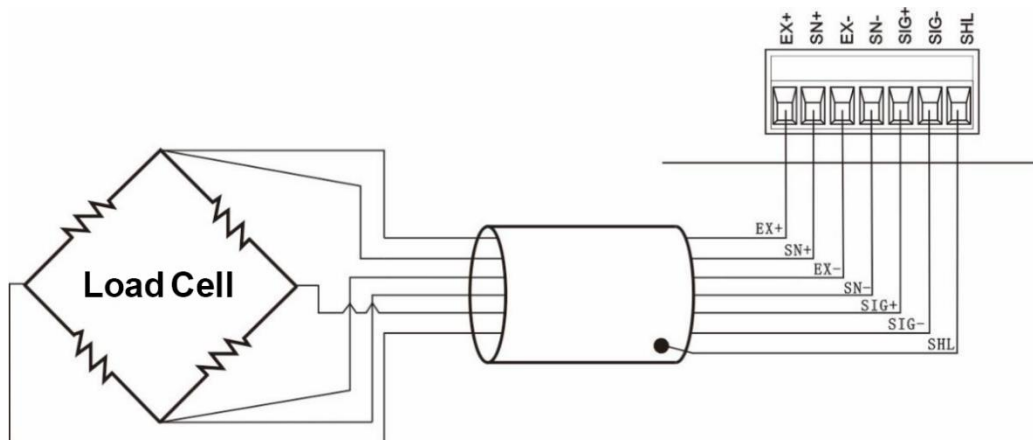

NOTE:

1. As the output signal of the load cell is an analog signal sensitive to electronic noise, shielded cables should be used for load cell wiring and laid separately from other cables, especially away from ac power supply
2. For the occasions with short transmission distance and little temperature change or low accuracy requirements, four-wire load cell can be selected. However, for applications requiring high transmission distance or accuracy, a six-wire load cell should be selected.
3. For the application of multi-load cell parallel connection, the sensitivity (mV/V) of each load cell should be consistent.

3.3 Connection of I/O Terminal

GMT-X1 weighing transmitter I/O module is an optional interface function. Two interfaces are optional.

Option 1: 3 IN 5 OUT (or can choose 3 IN 4 OUT relay output connector)

Option 2: 2 IN 4 OUT

Standard IO is transistor collector open output mode with each drive current of 200mA

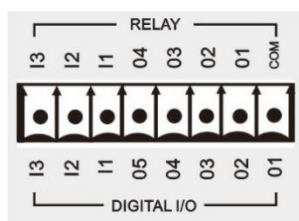

Option 1

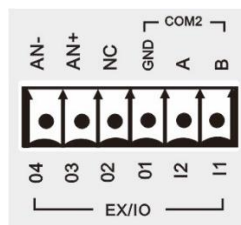

Option 2

The factory default low level of input and output interfaces is valid. The user can set this in **[Input Cfg] [Output Cfg]** parameter

The input port unified level mode, that is, the IN1 mode is set as high level, then IN2 and IN3 are set as high level simultaneously and are effective. The output port can be set to high and low level mode separately

IO wiring instructions:

Connect the instrument to external devices through wiring, control the instrument through external inputs to perform functions such as zeroing, cleaning tare, printing, etc., and display the current status of the instrument through output, such as zero point, stability, or a comparator output.

Taking the optional 3-in-5-out transistor expansion interface as an example:

Input interface connection: Connect the terminals of the external control device to the input terminals of the controller one-on-one, and test the connection through 521x input testing. Connection successful, enter the 32xx input port configuration, set the functions, level modes, and debounce time parameters of each input port. For example, if input port 1 is set to **ZERO**, press the corresponding external device connection port button, and the instrument will perform a zero operation (within the zero range). The other input port functions are operated in the same way.

Output interface connection: Connect the external indicator device terminals to the controller's output terminals one-to-one, and test the connection through 522x output testing. Connection successful, enter the 33xx output port configuration, set the functions and level mode parameters of each output port. For example, if output port 1 is set to stable, the instrument weight will be in a stable state, and the corresponding indicator light of the external output port will light up. At this time, the instrument stable output is effective. The same operation applies to other output port functions.

Transmitter input interface schematic diagram

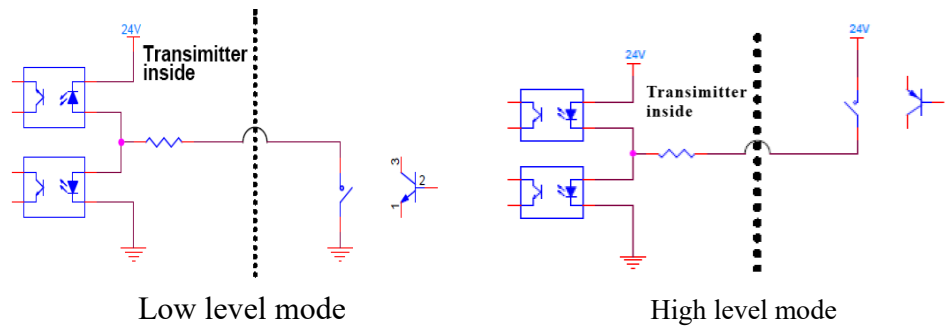

Schematic diagram of transmitter output interface

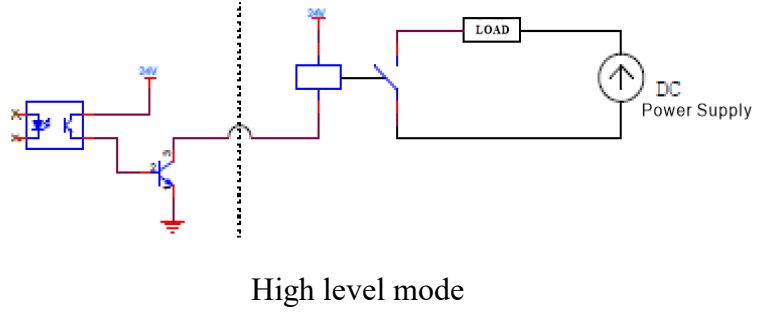
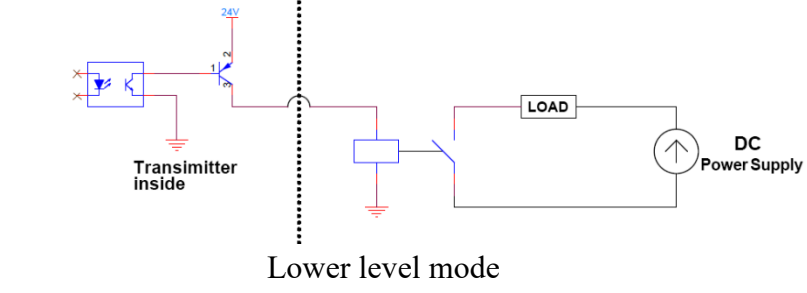

The default definition is as follows:

Output		Input	
OUT1	NONE	IN1	NONE
OUT2	NONE	IN2	NONE
OUT3	NONE	IN3	NONE
OUT4	NONE		
OUT5	NONE		

3.4 Connection of Analog

GMT-X1 have analog output function, 1 channel analog output function is optional. Interface AN+ (positive), AN- (negative).

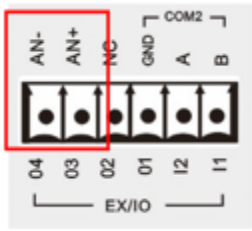

Analog output can be divided into two types: voltage output and current output. User can select the corresponding mode in the output mode

Please refer to analog mode and calibration [8.3 analog parameters](#).

3.5 Serial Port Output

GMT-X1 instrument configuration includes 2 serial ports: 1 RS485 and 1 RS232/485 (software parameter selection). Optional interface 2 can be equipped with 1 RS485 (order declaration).

COM0: Standard serial port

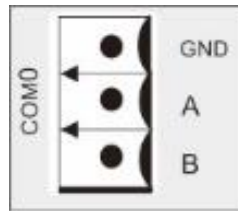

COM1: Standard serial port, **RS232/RS485** (Parameter 427x selection)

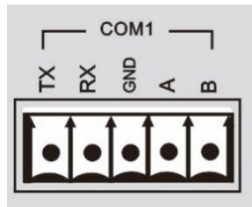

COM2: Serial port optional

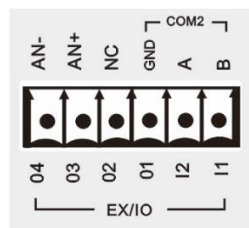

RS232 connection mode:

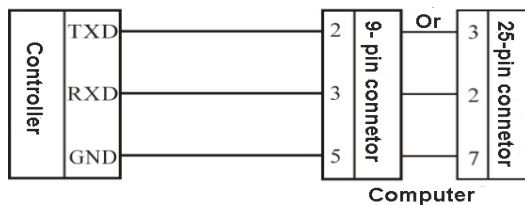

RS485 connection mode:

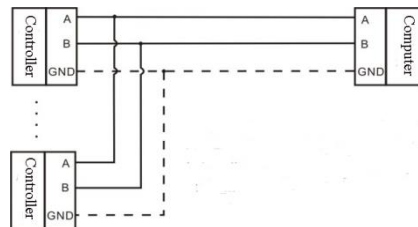

※ GND is ground of RS485, it can very much improve communication quality via connecting with GND by low-resistance wire when there is a lot of disturbance in working field.

※ GND must be connected in RS232 mode

3.5.1 Serial port fault troubleshooting

If serial port can't communicate, please check:

- Check the wiring according to the above wiring method to ensure that the wiring is correct.
RS232 must connect 3 lines, **Rx,Tx,GND**.
RS485 must connect line **A,B**.
- Make sure connecting port parameters are the same to computer.
COM ID, baud rate,data format and communication protocol must consistent with the computer and PLC.

3.6 NetCom Connection

GMT-X1 support NetCOM communication and **PN/EIP/CCLink-IE/Ether CAT/Profibus-DP** bus communication mode (optional fuction, make statement when order) .Support **TCP** protocol (**Modbus/TCP, Cont-A/TCP, Cont-B/TCP, r-Cont/TCP, rE-Cont/TCP, YH/TCP**) and **EIP/PN/CCLink-IE/ Ether CAT/DP** bus protocol.

- 1)Dual network port optional, NetCOM has built-in switch, easy to cascade.
- 2)Single network port option, support TCP protocol. The NET2 port is valid.
- 3) When communicating with PN/EIP/CC Link IE Filed Basic, any network port of the instrument can be connected for communication.
- 4) When communicating with Ethernet CAT, Net2 serves as the entry point. When connecting to multiple devices, the devices must be connected in series to distinguish the order of entry and exit. For specific parameter settings, please refer to section 10.12 Ether-CAT Communication.

3.6.1 NetCom fault troubleshooting

If NetCom can't communicate, please check:

- Check NetCom indicator light
Hardware connect normal, power supply indicator is on.
Cable connect normal,the connector indicator is flash.
- Check communication protocol is consistent with computer and PLC.
- Make sure **GMT-X1** can be **PING** by the network. If not, check the hardware interface section.
- Confirm if there are IP conflicts.
- Restart

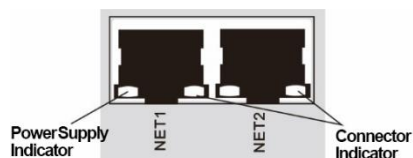

3.7 CAN Connection

Support **1** way **CAN** communicate interface, can communicate with computer. **GMT-X1** module can connect to bus network as a slave station module, baud rate support **100K,125K,250K,500K,1000K**.

Connect to the CAN bus,connect method refer to below charts,The dip switch is used to set whether to install an adaptive resistor. For non communication terminal modules, please make sure to turn this switch to the "OFF" end. Refer to Chapter 8.6 for parameter settings

and Chapter 10.9 for communication protocol content.

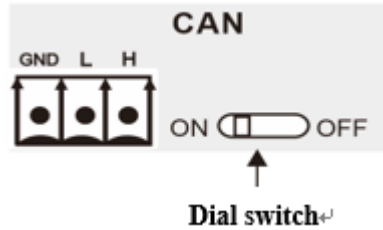

3.8 PROFIBUS bus Connection

The table provides a PROFIBUS interface (optional interface, to be declared for ordering). For specific DP parameter settings, please refer to section 10.10 DP Communication. And the interface definition on the right:

Attention: The terminal of the bus needs to be equipped with an adaptive resistor (120R).

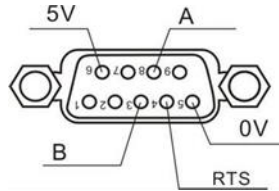

4 Menu Review

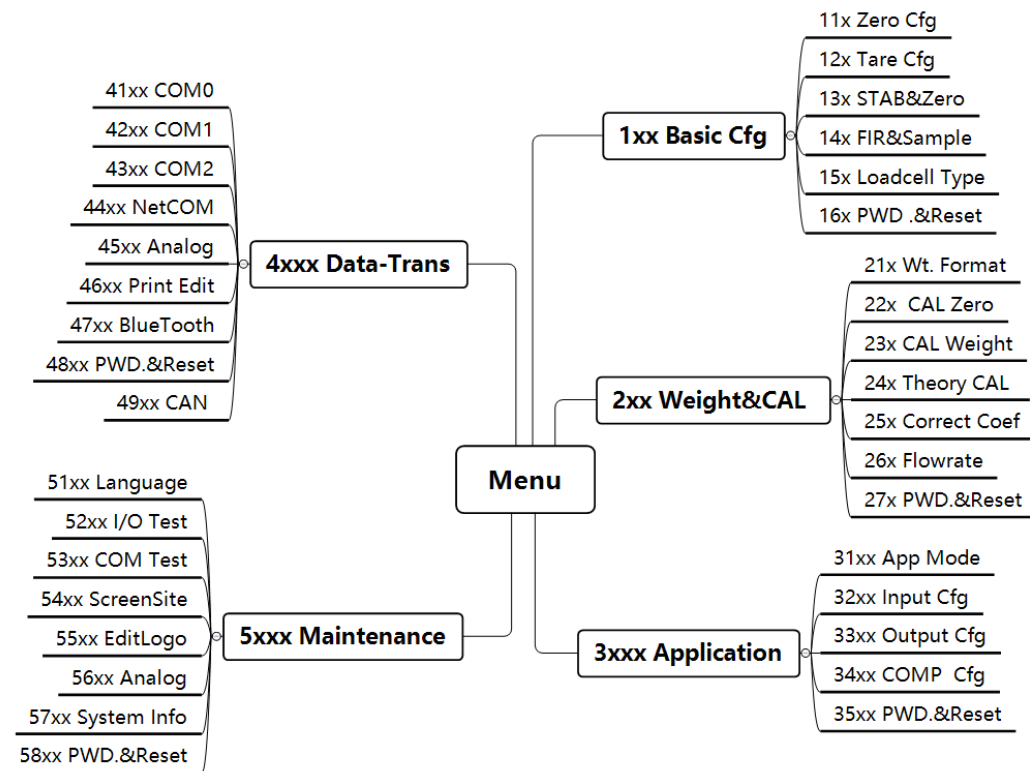

4.1 Parameter option and setting

Parameter option: (Select tare operation switch parameter)

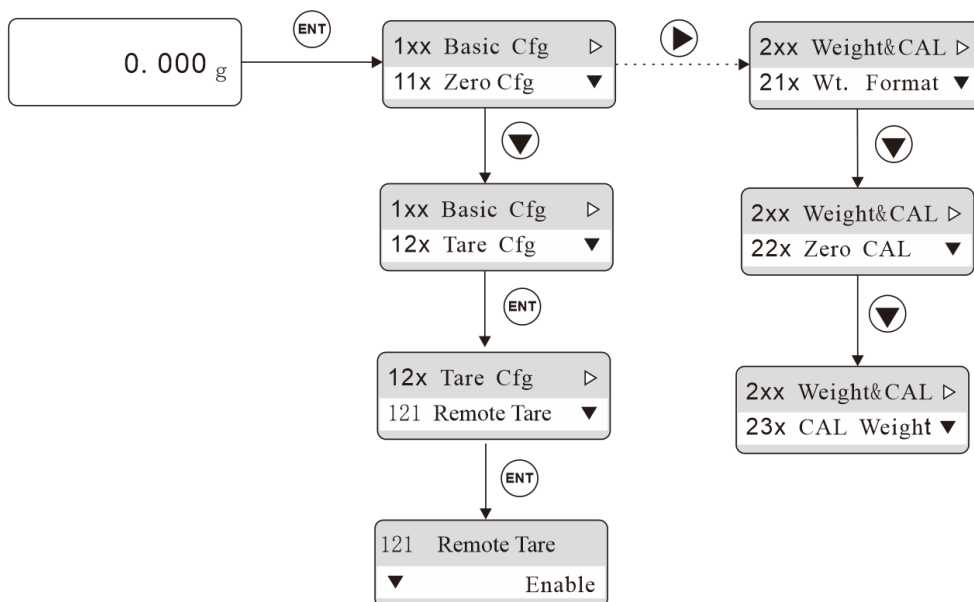

Parameter Setting: (Set the PWR-On Zero range from 49% to 30%)

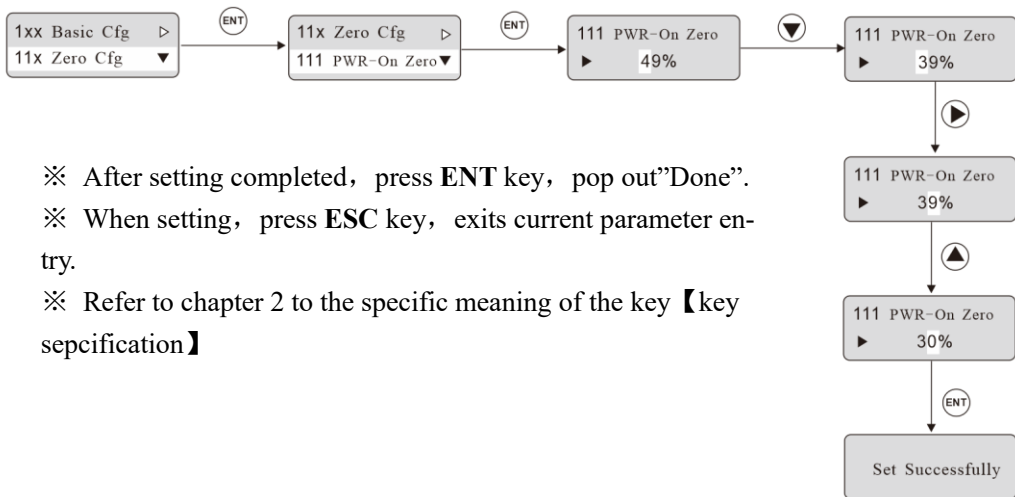

- ※ After setting completed, press **ENT** key, pop out "Done".
- ※ When setting, press **ESC** key, exits current parameter entry.
- ※ Refer to chapter 2 to the specific meaning of the key **【key specification】**

5. Basic Cfg parameter

5.1 Content

Parameter	DefaultValue	Decription
11x Zero Cfg		
111 PWR-On Zero	0%	Range: 0~99 (×full range%); When set to 0 , turn off PWR-On Zero; 1-100 :according full range 1-100% zeroing; 101 :reset to last zero before turn off.
112 Remote Zero	Enable	After enabling, the zeroing operation can be carried out through the communication port.If set to disable, the communication port can not be reset.
113 Zero Range	20%	Range: 1~99 (×full range %)
12x Tare Cfg		
121 Remote Tare	Enable	Range:Enable; Disable
122 Tare Record	Disable	Range:Enable; Disable
123 NetSign COR	Disable	Range:Disable; Correct Tare; BackToGross
124 Preset Tare	0	Range: 0~ Full Scale
13x STAB&TrZero		
131 STAB Range	1	Range: 0-99 ,When the parameter is 0, turn off the STAB function and the weight STAB marker is always in effect.When the parameter is not 0, if the weight change range is not greater than this value, the weight is stable during the stability determination time.
132 STAB Timer	1000ms	Range: 1-5000 , Milliseconds.If the weight range does not exceed the STAB range during that time, the weight is stable
133 TrZero Range	1d	Range: 0-99d .Turn off the zero tracking function when the parameter is 0.When the parameter is not zero, the weight change is less than the range of zero tracking time, the system will automatically track zero.
134 TrZero Time	1000ms	Range: 1-5000ms , during the tracking time, if the weight change is less than the tracking range, the system will automatically track the zero position
14x FIR&Sample		
141 Digit-Filter	4	Range: 0-9 ; The larger the number is, the higher the filtering intensity will be, but the response time will be longer.
142 Adv. Filter	0d	That is defibrillate Filter.Range 0-99d , At 0, the steady-state filter is turned off.When the parameter is non-zero, if the weight change is within the range, then the steady-state filter is

		started.
143 AD Sample Rate	200	Range: 50; 60; 100; 120; 200; 240; 400; 480; 800; 960 (SPS) .
15x LoadcellType		
151 Input Range	0-10mV	Range: 0-5mV; 0-10mV; 0-15mV, -5-5mV; -10-10mV;-15-15mV. The meter adjusts the signal acquisition range according to the input range to ensure more accurate metering. This instrument uses 5V bridge, 1mv/V sensor, signal range is 0~5mV, and so on.
16x PWD.&Reset		
161 Reset Basic	//	Restore factory setting operation for basic parameters
162 Remote Edit	Enable	After enabling, the basic parameters can be set through the communication port. Otherwise, the communication port is read-only to the basic parameters.
163 PWD. Protect	Disable	Setting range:Enable;Disable
164 PWD. Edit	000000	To change the password for accessing basic parameters, enter the old and new passwords.

5.2 Zero Cfg

Zero success condition:

- 1) Weighing platform stable; 2) Weight is in zero range.

Zero Cfg:

- 1) Press Zero; 2) Zero input port is valid; 3) communicate port zero (Remote Zero is ON)

5.3 Tare function

Remote Tare Switch:

Enable/Disable Tare functions such as Tare and Clear Tare by the serial port. The tare weight can be set only when this parameter is enabled.

Tare Record:

Enable/Disable Tare Record function. If is enable, power off restart, retain tare weight.

NetSign COR:

Disable: -NetSign have no operation.

Correct Tare: When transmitter in net weight status, the net weight is negative and weight is stable, then indicator will correct tare value to ensure Net weight is not negative.

BackToGross: When transmitter in net weight status, the net weight is negative and weight is stable, then indicator will back to gross weight status

Preset Tare:

Set tare weight, if the value is not 0, then this tare weight is used for tare.

※NOTE: ① The transmitter is in gross weight state, when clear tare, transmitter record tare, enter Net weight mode.

② The transmitter can't be reset in the mode of Net Weight.

③ When the tare record function and PWR-On zero are simultaneously activated, PWR-On zero does not take effect

6. Weight Format

When GMT-X1 weight transmitter or any part of the weighing system is changed for the first time and the current equipment calibration parameters can't meet the user's requirements, the display shall be calibrated. Calibration can determine the system zero and gain of the weighing system.

6.1 Weight Format

Parameter	Initial Value	Description
21x Wt. Format		
211 Unit	kg	Range: t; kg; g; lb
212 Decimal	0	Range: 0; 0.0; 0.00; 0.000; 0.0000 (Note: No need to re-calibrate after modification)
213 Division	d=1	Range: d=1, d=2, d=5, d=10, d=20, d=50, d=100, d=200, d=500, default: d=1
214 Full Scale	10000	The full range value of the transmitter is generally taken from the load cell range, and when it exceeds the range, prompt message is given, so as not to damage the load cell by weighing over pressure .Range: 0~999999.
22x CAL Zero		
221 Auto Capture		After emptying the scale, press the "OK" button and set the current state to zero
222 Key In mV		Manually and manually input the voltage of 4 decimal points as the zero point voltage
23x CAL Weight		
231 Weight CP1		Calibrate weight points, support 5-point calibration. When the front point is calibrated, the other weight points will be reset to the uncalibrated state (the default value is 10.0000mV, 10000kg). If the marking point 1 is performed, the marking point 2-5 is reset to 0
232 Weight CP2		
233 Weight CP3		
234 Weight CP4		
235 Weight CP5		
24x Theory CAL		
241 LC mV/V	2.0000	True load cell sensitivity, 4 decimal points, average sensitivity if multiple load cells
242 LC Capacity	10000	The true load cell range, if there are more than one load cell, is the sum of all load cell ranges.
243 Use T-CAL	Disable	Enable calibration of theoretical values and make them effective. Range: Enable;Disable.
25x Correct Coef		
Correct Coef	1.00000	After calibration, if the zero point is correct, the weight has deviation, which can be used to correct the weight value.The value calculation: if the transmitter weight is A, but the

		weight after weighing is B, the correction coefficient is calculated: (actual weight × current correction coefficient)/B shows A weight
26x Flowrate		
261 SampleWindow	1.000s	Range: 0.500-60.000s . Define the length of sample window for flowrate calculation.
262 Max Flowrate	10000	Range 0-999999 , Define the max flowrate value. For analog output indication.
263 FlowrateUnit	Hour	Range: 0-Hour, 1-Minute, Define Flowrate display unit.
27x PWD.&Reset		
271 Cal Reset	//	Restore factory setting operation for calibration parameters (hardware protection switch must be disable)
272 Remote Cal	Disable	After enabling, the calibration parameters can be set through the communication port. Otherwise, the communication port is read-only to the basic parameters. Range: Enable;Disable.
273 HWD. Protect	Disable	Calibration is not allowed until the hardware protection dial code is enabled in the ON position. Range: Enable;Disable.
274 PWD. Protect	Disable	After enabling to enter the change parameter setting option requires password, password is required when switching. Range: Enable;Disable.
275 PWD. Edit	000000	To change the password for accessing basic parameters, enter the old and new passwords.

6.2 CAL Zero

Zero calibration is the zero calibration of the scale.

Zero calibration can be done in two ways: automatic acquisition and manual input. The “Auto Capture “method must be used for zero calibration when new equipment or weighing structure is adjusted.

Auto Capture:

Calibration conditions: stable scale

Transmitter displays current millivolt. After empty the scale, press ENT to calibrate the current state to zero.

Loadcell value 0. 6688mV

Key In mV:

User need key in voltage value of ZERO point to calibrate ZERO

222 Key In mV 00. 0000mV

※Generally used for no-weight calibration, the value recorded by the data recorded during the calibration of

the weights is used for Key In mV.

6.3 CAL Weight

Cal weight is to use standard weights for weight calibration.

Supports 5-point calibration, providing users with the maximum ability to select calibration points according to their needs.

Calibration method:

※ Zero calibration should be completed before weight calibration

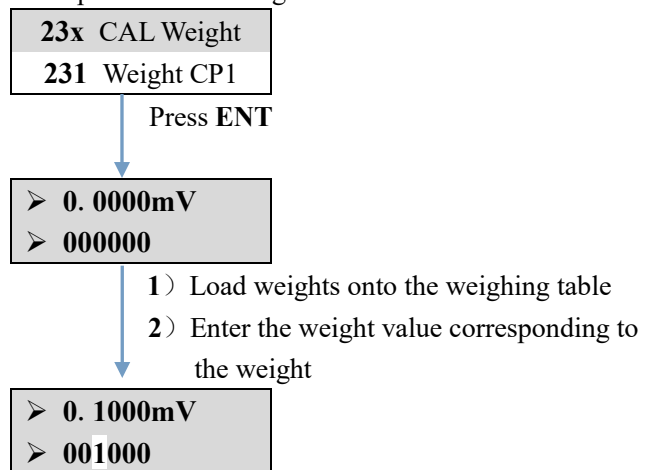

Multi-point calibration attention:

- 1) User can choose the number of marking points, such as single point calibration, which can be withdrawn after the first weight point is calibrated
- 2) Cross-point calibration is not allowed. For example, when using 3-point calibration, it is necessary to calibrate the Weight CP1, 2 and 3, but it is not possible to calibrate the Weight CP3 and 4 by crossing the Weight CP2 after the completion of the Weight CP1
- 3) In the multi-point calibration, the weight should be increased. For example, the weight of Weight CP2 must be heavier than the weight of Weight CP1

6.4 Theory CAL

Calibration of theory value means that weight calibration is performed by inputting load cell sensitivity and load cell range value

Theory CAL takes 3 steps:

- 1) Set load cell sensitivity (If multiple load cell are connected, input the mean value)
- 2) Set total range of the load cell (If connected to more than one load cell, input total range)
- 3) Turn on "Use T-CAL" key.

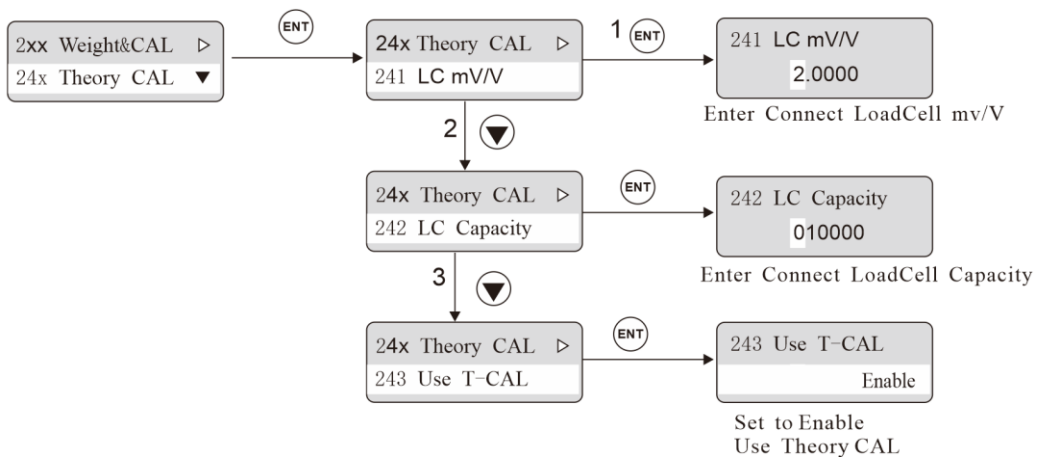

6.5 Calibration lock application

GMT-X1 calibration has dual switch protection:

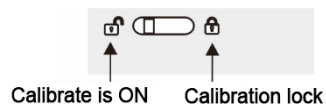

1) 273 hardware protection(HWD. Protect):

If this parameter is set to Enable, the status of external hardware toggle switch is judged. If the external switch is turned on, calibration is allowed. Dial to lock, calibration is not allowed. If this parameter is set to Disable, the hardware switch status is not determined.

2) 272 remote calibration(Remote Cal):

Remote calibration switch is the calibration parameter protection switch of communication port, restricted by the hardware protection status.

When the hardware protection switch is enable and the remote calibration switch is also set as enable, transmitter calibration can be carried out through the communication port. When the hardware protection switch is disable, no matter the remote calibration is set as enable or disable, transmitter calibration can not be carried out through the communication port.

7. Application setting

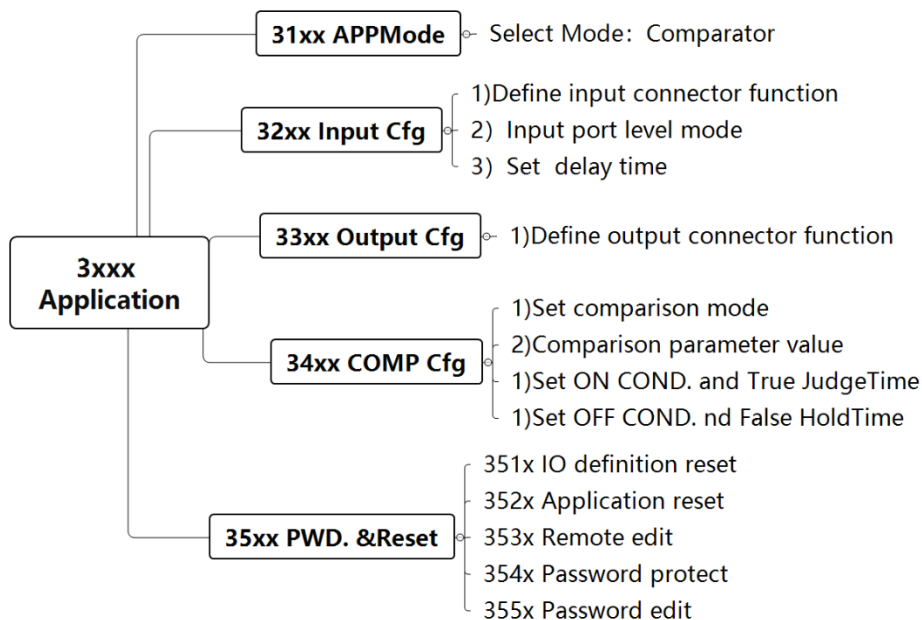

7.1 Input Cfg

The output port configuration parameter is in item 32xx of the transmitter. The transmitter is standard equipped with 3 input and 5 output, and can be extended with 2 input and 4 output, which can satisfy the function of 5 in and 9 out IO.

Each input port can set the application function, mode (high and low level is effective), delay time.

Parameter	Parameter Item	Specification
32xx Input Cfg (IN1–IN3 and Extend Port)	INx Function	NONE, ZERO, CAL-ZERO, TARE, CLEAR-TARE, GROSS/NET, COMP-ON, PRINT, P_EMPTY_LINE ※It is defined as none that is, the input port is nonfunctional
	INx Mode	Range: Low_Level, High_Level. Default: Low_Level. Define which type input signal to detect. (Note: IN 1 mode changes synchronously with IN 2/3 mode, and Extended IN1 mode changes synchronously with Extended IN2 mode)
	INx Delay Time	Avoid misjudgment caused by signal jitter. Initial Value: 5ms ; Range: 0–200ms

※ When select the IO add-on board in the special interface, the extension input 1 and input 2 will be available. The function, mode and debounce of the extension port are the same as the normal input port

Input port application function

Function	Implication
NONE	No input
ZERO	When this signal input is valid, the meter performs zero clearing.

CAL-ZERO	When this signal input is valid and (273) HWD. Protect is diasble, the instrument performs zero calibration
TARE	When the signal input is valid, the peeling function is performed.
CLEAR-TARE	hen the signal input is effective, it will perform the skin clearing function, that is, the removed tare weight recovery.
GROSS/NET	Switch gross/net weight when this signal input is valid.
COMP-ON (Level signal)	This function is defined and whether the output of the comparison point is controlled by the state of the IO port. If the comparison condition is true and the input is valid, the comparator output will be valid, otherwise it will not be output. If the function is not defined, the comparison condition is true and there is an output, which is not controlled by the input port.
PRINT	When this signal input is valid, the print function is performed.
P_EMPTY_LINE	In the non-print state, when the signal input is valid, the paper feed is printed for 1 line.

Example: Define Input2 as TARE

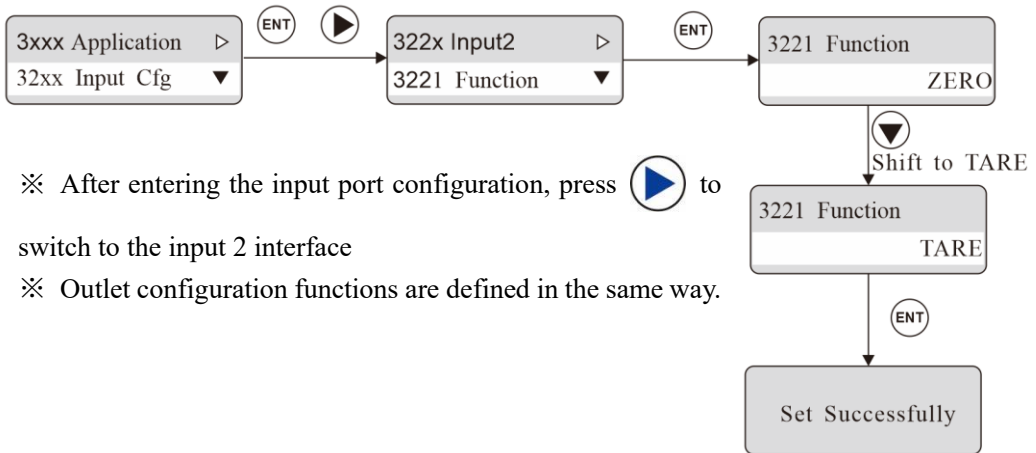

7.2 Output Cfg

Output Cfg is in item 33xx of the transmitter. Each output can set the application function and mode separately (high and low level is effective). No initial output by default. Must be defined by the customer.

Parameter	Parameter Item	Specification
33xx Output Cfg (O1-O5 and Extend Port)	Output X Function	Optional: NONE, COMP1-8, STABLE, ZERO, NET, PRINTING, -SIGN, COM-Pulse. ※ Define no function means Output no function.
	Output X Mode	Initial value: Low_level; Optional: High_level, Low_level; (Note: When Extension 1 is equipped with a 3-in-4-out relay output interface, Out1-Out4 are relay outputs and do not support mode switching. Other I/O extensions support mode switching.)

Output application function

Function	Implication
NONE	No-output
COMP 1-8	COMP 1-8 When achieve, has output.
STABLE	When STABLE is valid, has output





ZERO	Valid when Zero indicator light has output
NET	When is Net Weight, output is valid
PRINTING	When printing, output is valid
-SIGN	When weight is less than 0, output is valid
COM-Pulse	1HZ square wave is emitted only for serial communication

※ When the Extended IO Add-on Board is selected, the Extended Outlet 1-4 function selection is available. The function and mode of the Extended Outlet is the same as that of the ordinary Output.

7.3 Application

Application parameters are configured in item 34xx of the transmitter. In the application parameters, set the Comp. Mode, comparison conditions, effective time and failure time parameter values.

GMT-X1 has 8 Comp. Mode function, 341x—348x

Parameter	Specification
Comp. Mode	Weight/flow judgment: OFF; W<=CV1; W=CV1; W!=CV1; W>=CV1; CV1<=W<=CV2; W<[CV1,CV2]>W; F<=CV1; F=CV1; F!=CV1; F>=CV1; CV1<=F<=CV2; F<[CV1,CV2]>F
CompValue 1	The first priority is higher, and the default comparison value is taken when there is only one comparison parameter. Initial value: 0; Range: - 999999-999999. (Press   to switch the sign)
CompValue 2	Used when two comparison values are needed. The value must be greater than the initial value of the first comparison value: 0; Range: - 999999-999999. (Press   to switch the sign)
ON COND.	When the comparison is successful, the meter outputs additional constraints in effect. 0: Immediately output (as long as the comparison conditions are established immediately output); 1: Stable output (when the comparison conditions are established and the current weight is stable output); 2: Debounce mode (the success time exceeds the decision time output). Initial value: output immediately
TRUE JudgeT	The minimum decision time for success. Default: 1000ms ; Range: 0~50000ms
OFF COND.	The extra requirement for indicator to deactivate output when comparator equation is FALSE. Three options: Immediately, Stable, Debounce Immediately: output immediately OFF, if equation is FALSE; Stable: output OFF, if equation is FALSE and weight is stable; Debounce: output OFF, if equation is FALSE and and keep FALSE status longer than FALSE HoldT time ; In Programmer Mode, this parameter can not be seen.
FALSE HoldT	Range: 0-50000ms, default: 1000ms , If OFF COND. Is Delay mode, the comparator equation has to be FALSE and keep FALSE status longer than FALSE HoldT time to force indicator deactivate output signal if not Delay mode, this parameter can not be seen.. In Programmer Mode, this parameter can not be seen.

7.4 Application Example

Example 1: When the weight is greater than or equal to 500g, the output 1 is valid; when the weight is not satisfied and the weight is stable, the output 1 is invalid.

Setting: 1) Output Config → Output -1 Set to: COMP 1

2) Compare mode set to: $W \leq CV1$

3) COMP Value-1 Set to: 500.

4) COMP Value-2 is set to: 0 (single point comparison, this parameter is meaningless).

5) ON COND. set to: Stable ,output after the weight is stable.

6) TRUE JudgeT: 0 (non-delay mode, this parameter is meaningless).

7) OFF COND. set to: Stable, invalid after the weight is stable

8) FALSE HoldT: 0 (non-delay mode, this parameter is meaningless)

※ If the weight is greater than or equal to 500g, the steady state has been invalid, the output 1 will not be switched to the effective state.

Example 2: The weight is not between 200g and 500g, and the output 4 is effective after 5mS delay; if the condition is not met, the output 4 is invalid after 5mS delay.

Setting: 1) Outlet 4 is set to: Comparator 1

2) Compare mode is set to: $W < [CV1, CV2] > W$.

3) COMP Value-1 is set to: 200.

4) COMP Value-2 is set to 500 (this value should be greater than 4.3.1.2).

5) ON COND. is set as: Delay output

6) TRUE JudgeT set to: 5ms.

7) OFF COND. set to Debounce output.

8) FALSE HoldT: 5ms.

Example 3: If the input switching quantity is set to COMP-ON function and the weight is between 200g and 300g, the immediate output is effective. If the conditions are not met, the immediate output is invalid.

Setting:

1) Switching quantity input port IN1 is set to: Enable comparison point.

2) Output Config → Output -1 Set to: COMP 1

3) Compare mode set to: $CV1 \leq W \leq CV2$.

4) COMP Value-1 is set to: 200.

5) COMP Value-2 is set to: 300 (this item set value should be greater than compare value 1).

6) ON COND. set to: Output immediately.

7) TRUE JudgeT: 0ms (non-delay mode, this parameter is meaningless).

8) OFF COND. set to: Output immediately.

9) FALSE HoldT: 0ms (non-delay mode, this parameter is meaningless).

If the weight is between 200 and 300g, although the comparison condition is met, the comparator will not output immediately until the input of the enable comparison point is effective; If the conditions are not met, the output will be invalid immediately.

8. Data-Trans

GMT-X1 has various communication function interfaces: 1 channel RS485 (serial port 0), 1 channel RS232/485 (serial port 1), 1 channel RS485 optional port (serial port 2), 1 channel analog optional interface, 1 network port communication interface, bus communication interface and DP bus communication interface.(support TCP, PN/EIP/**CCLink-IE/Pro-fibus-DP/EtherCAT** bus functions).

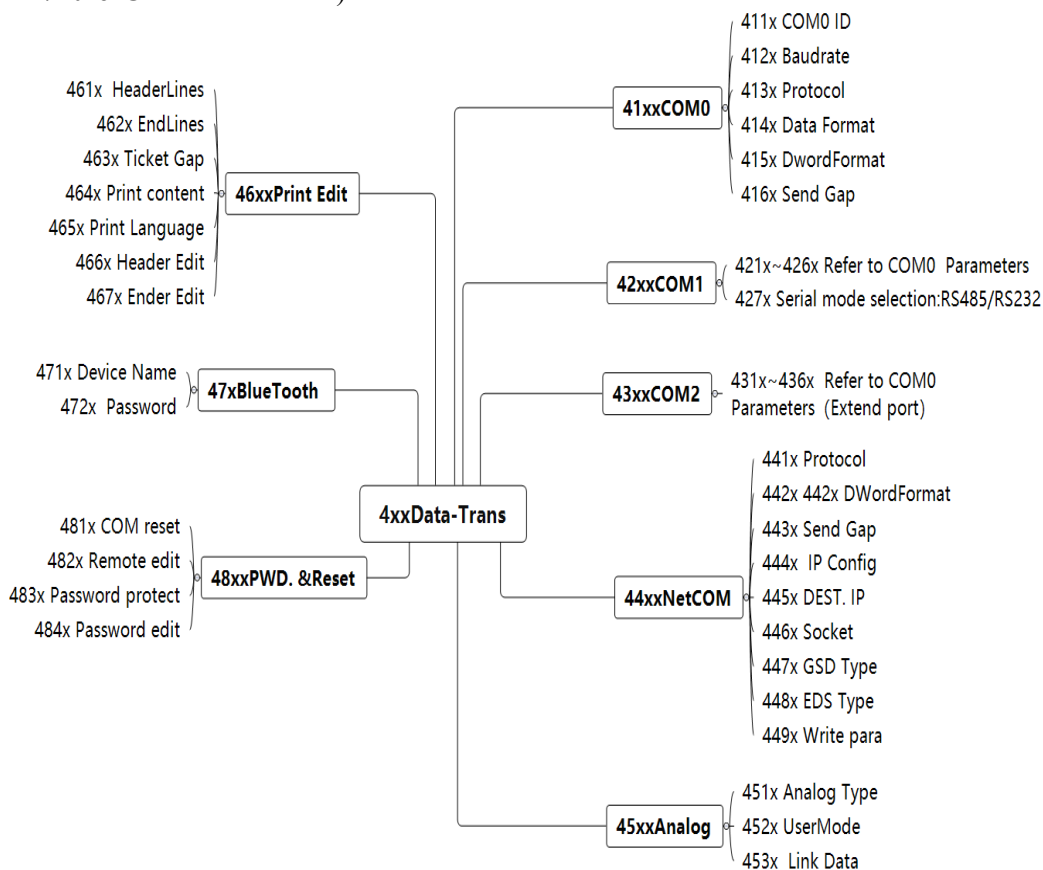

8.1 Serial port parameters

Parameters	Initial Value	Specification
411x COM0 ID	01	Range: 01-99
412x Baudrate	38400	Range: 1200, 2400, 4800, 9600, 19200, 38400, 57600, 115200
413x Protocol	Modbus RTU	Range: ModbusRTU, ModbusAscii, Continuous sendA (CB920), Continuous send B (tt), r-Cont, rE-Cont, YH Protocol, Print
414x DataFormat	8-E-1	Range: 8-N-1, 8-E-1, 8-O-1, 7-N-1, 7-E-1, 7-O-1
415x DwordFormat	AB-CD	AB-CD (Hi low), CD-AB (Low Hi) optional.
416x Send Gap	20ms	Under continuous transmission protocol, the time interval between frames. Range 0-1000ms, Default: 20ms
427x RS485/RS232	485	Range: 485 mode, 232 mode is optional.

		※ Parameter only available under serial port 1
--	--	--

※ For other serial port parameters, please refer to the parameter table of COM0 above. Among them, COM2 supports 427x serial port mode switching.

8.2 NetCOM parameters

8.2.1 Parameters description

Parameters	Initial Value	Specification
441x Protocol	Modbus/TCP	When selecting a normal network port, the protocol has Modbus/TCP,Cont-A/TCP,Cont-B/TCP,r-Cont/TCP, rE-Cont/TCP, YH/TCP , default Modbus/TCP
442xDWord mode	AB-CD	Range: AB-CD (Hi-Lo) , CD-AB (Lo-Hi)
443x Send Gap	20ms	When you select UDP mode to send, the parameters are visible and used to control the time interval between frames.The range of 0-1000 ms Parameters are not visible when other protocols are selected
444x IP Config	192.168.0.100	This parameter is not visible if there is no additional board for the NetCOM port.
445x DEST. IP	192.168.0.101	The IP of the destination address is visible only when using the UDP-type protocol, otherwise It's not visible
446x Socket	502	Range: 1-65535
447x GSD Type	Simple	Standard/Simple/Simple2 optional; If the PN bus communication method is selected, Standard:Use the original GSD, chapter 10.7.1.1 Simple: GSD is a simplified version of the standard GSD, for which please refer to Chapter 10.7.1.2 . Simple2: Use a simplified version of the loop parameters, please refer to Chapter 10.7.1.2 .(Note: Simple2 is no more than a loop parameter for compatibility with company blue label versions)
448x EDS Type	Simple	The EIP buscommunication mode, Standard: Use the original EDS , chapter 10.8.1.1 . Simple:EDS is a simplified version of the standard GSD, for which please refer to Chapter 10.8.1.2 .
449x Write para	Disable	Range: Disable, Enable ;(This parameter is available when the PN/EIP/CCLink IE additional board is selected) Enable :During PN/EIP/CCLink IE communication, instrument parameters are controlled by "Module Parameters" in the master station configuration, and the parameters set in "Module parameters" are automatically written to the instrument when the instrument is powered on. Disable : PN/EIP/CCLink IEcommunicating,parameters are not controlled by the master station "module parameters".

8.2.2 Built-in web -Weasy device management system

The web page system supports switching between Chinese and English. The browser language must be set to English.

System login:

Step1: set network port parameter -444x IP config in the transmitter. The default communication protocol is **modbus/TCP**, for example, **192.168.101.10** (note: the IP address must be on the same network segment as the IP address used to access the computer).

Step2: enter the IP address **192.168.101.10** set by the transmitter in the computer browser, open the device management system, and enter the user name (**GAdmin**) and password(123456) to log in to the system.

Step3: click pause on the main interface, the page will stop refreshing, click continue to resume refreshing.

Step4: set the parameters of the transmitter under the web page, and synchronize them to the transmitter after submission.

As below:

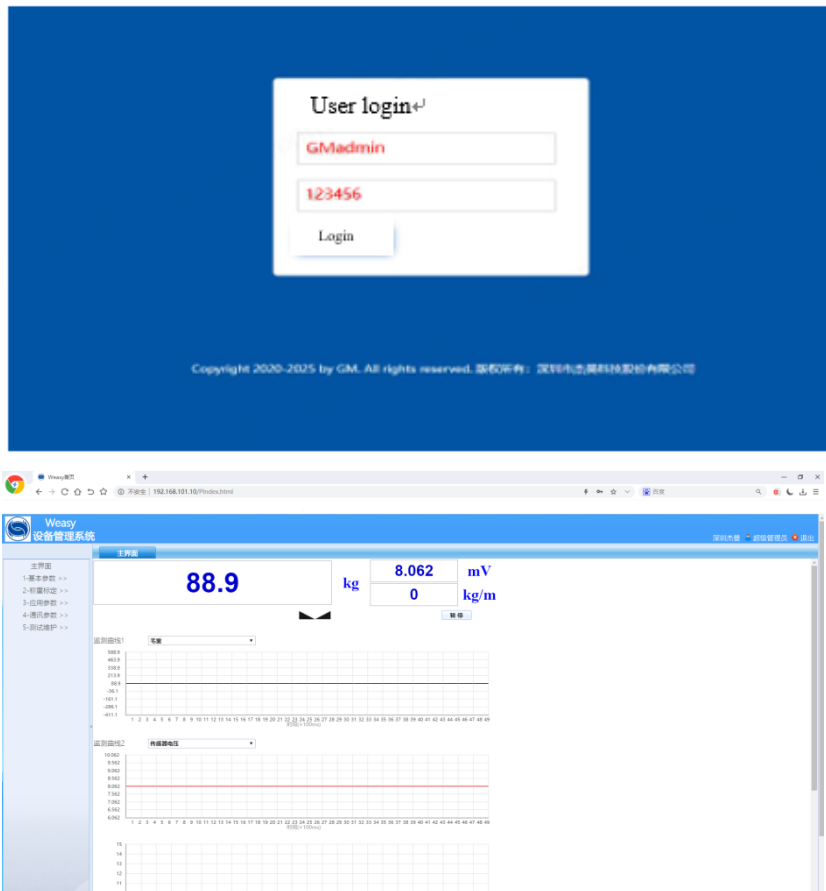

※Note: The reset of all parameters cannot be reset through the web page. In addition, the printing format of communication parameters and bluetooth connection cannot be modified.

8.3 Analog Parameters

Parameters		Initial Value	Specification
451x Analog Type		4-20mA	Range: 4-20mA; 0-10V; User-mA, User-V.
452xUser Mode	4521 Min. Out	0	The parameter is valid in user power and user voltage modes.
	4522 Zero Out	0	
	4523 F.S. Out	0	
	4524 Max. Out	0	
453x Link Data		Weight	Range: Weight,flow, GW, NW Analog corresponds to weight form

8.4 Print Edit

When serial port parameter is set to "Print", press  on the main screen to Print the data.

Print Parameters		Initial Value	Specification
461x HeaderLines		1	Range 0-4
462x EndLines		1	Range 0-4
463x Ticket Gap		2	Range 0-99
464x Content		Display Wt	Optional: DisplayWt, Gross Wt, Net Wt, FlowRate, Net+Tare (two lines), Gross+FlowRate, All Info (Gross weight + Net weight + Tare) (print includes units)
465x Print Lang		English	Chinese, English
466x Header Edit	4661 HeaderLine 1	-----	HeaderLine, Can edit 16 English characters
	4662 HeaderLine 2	-----	
	4663 HeaderLine 3	-----	
	4664 HeaderLine 4	-----	
467x Ender Edit	4671 EnderLine 1	-----	EnderLine, Can edit 16 English characters
	4672 EnderLine 2	-----	
	4673 EnderLine 3	-----	
	4674 EnderLine 4	-----	

Example:

Parameters Setting		Print Content (English)
HeaderLine	2	-----
EnderLine	1	-----TEST-----
Ticket Gap	3	No. Xxxxxxxx1
Content	Display weight	Display weight
Print Lang	English	NT -X.XXXX kg
HeaderLine 1	-----	-----END1-----
HeaderLine 2	-----TEST-----	

EnderLine 1	-----END1-----	----- (Print 2rd)

8.5 Bluetooth communication

Parameters	Initial value	Description
471x Device name	Default value	Up to 6 English characters can be edited. range: '-', 0-9, A-Z, a-z , blank
472x password	000000	Enter this password when connect bluetooth

8.6 CAN communication

CAN Parameters	Initial value	Description
491x CAN ID	01	Range: 01-127
492x Baudrate	250K	Range: 100K, 125K, 250K, 500K, 1000K
493x Content	Weight	Range:Weight,Voltage
494x Send Gap	20ms	Range: 0-5000ms , Set to 0 to disable active reporting and support question and answer mode on the upper computer. Set to a non-zero value, maintain active reporting mode, and report data at the set time interval.

9. Maintenance

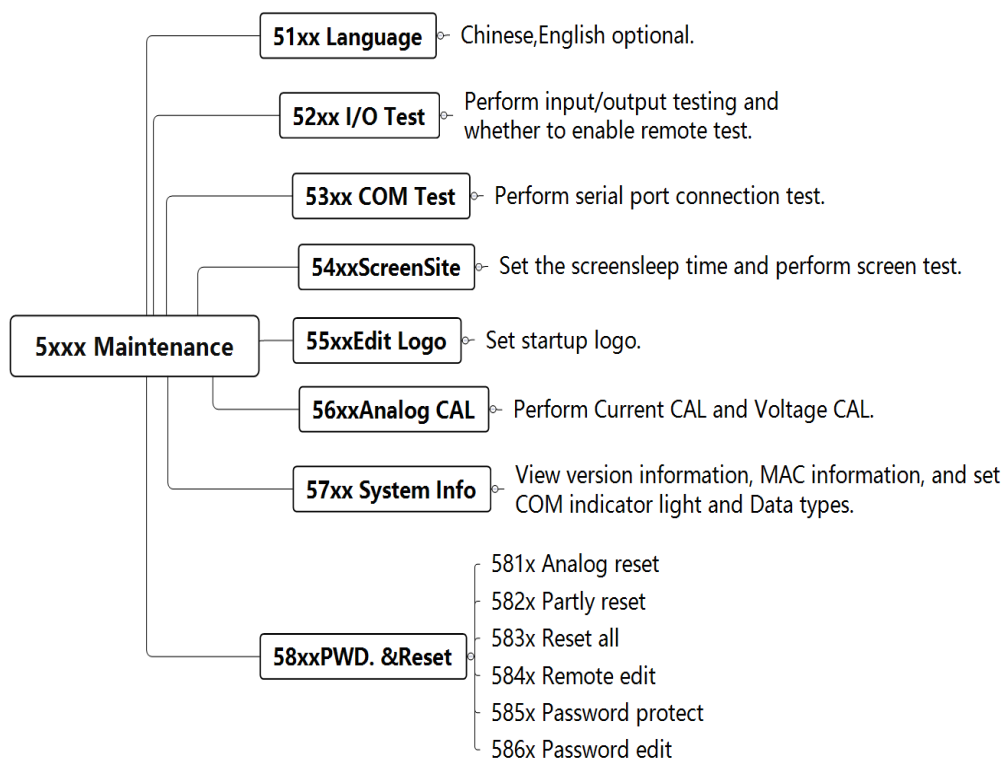

9.1 Parameter Specification

Maintenance	Parameters	Specification
51xx Language	Initial value :Chinese; Chinese,English optional.	
52xx I/O Test	521x Input Test	For details, see Chapter 9.2 I/O Test .
	522x OutPut Test	
	523x Remote Test	After opening, the switch quantity can be tested remotely through communication.
53xx COM Test	531x Send Test	For details, see Chapter 9.3 COM Test .
	532x Receive Test	
54xx ScreenSite	541x ScreenSleep	Set screen off time. Default: 600s, Range:0~3600s.Set to 0 to indicate that it will not turn off
	542x ScreenTest	When the screen is white and all indicators are on,the screen is normal.
55xxEdit Logo	Edit Logo,support 8 character,only support digit,English letters and blank,"-","_",long press the up button change case,edit are protected by passwords.	
56xx Analog CAL	561xCurrent CAL	Detail operation refer to 9.4 Analog CAL .
	562xVoltage CAL	
57xx System Info	571xMAC Address	View the MAC address of a meter ,which can only be queried and cannot be modified.

	572x BTH MAC	View the bluetooth MAC address of a meter , which can only be queried and cannot be modified.
	573x Version	Query the software version and compilation date, which can only be queried and cannot be modified.
	574x Serial No.	Display the 138 number of the meter, which can only be queried and cannot be modified.
	575x MV Coef	Default: 1.0000 ; Used to calibrate the input voltage of the instrument sensor. It can only be queried but not modified.
	576x COM LED	Default: COM0 , optional: COM0, COM 1, COM 2, NetCOM, CAN ; Defines which serial port the COM indicator on the front panel blinks during communication.
	577x WT Data Type	Initial value: Int; Optional: Int , Float. This parameter is used to switch between integer weight and floating-point weight in the weight display of communication parameters when communicating through PN/EIP/CCLink IE/EtherCAT.
58xx Oiml SWitch		Initial value: OFF, currently fixed asOFF. When set to on, switch to the OIML authentication related parameter interface.
59xxPWD.&Reset	591x DA CAL RST.	Restores analog parameters to factory Settings.
	592x Partly RST.	Restore all paracontrollers of the controller (except calibration paracontrollers) to factory setting values.
	593x Full Reset.	Restore all the paracontroller values of the controller to the factory settings.
	594x Remote Edit	Enable,Disable Optional. After this function is enabled, you can set maintenance parameters through the communication port. Otherwise, the communication port is read-only to maintenance parameters.
	595xPWD Protest	Enable,Disable Optional. After this function is enabled, you need to enter the password for accessing maintenance parameters.
	596x PWD Edit	This parameter can change the password for accessing maintenance parameters.

9.2 IO Test

IO The test function is used to test whether the connection state of the input/output outlet is normal.

Input Test:

5xxx Maintenance ▷
52xx I/O TEST ▾

※ Enter 1 to test OK, press the key  to switch the input port for testing
 ※ After the test is completed, press the ESC key to exit the Input test state

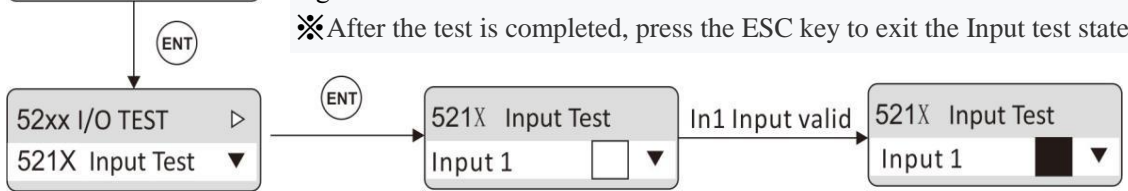

Output Test:

5xxx Maintenance ▷
52xx I/O TEST ▾

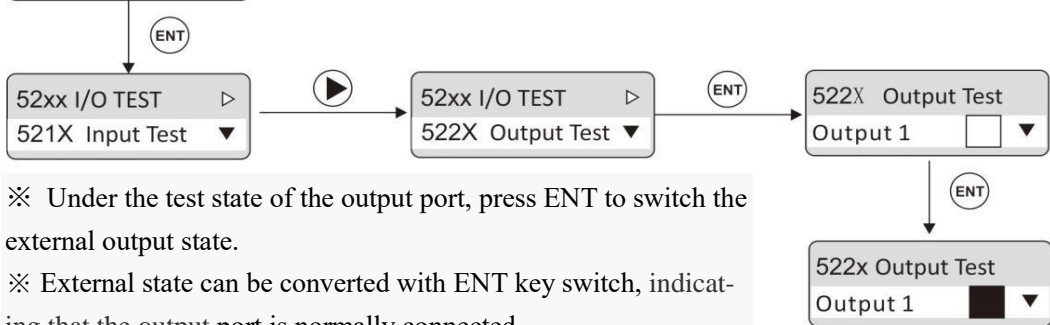

※ Under the test state of the output port, press ENT to switch the external output state.
 ※ External state can be converted with ENT key switch, indicating that the output port is normally connected.
 ※ After the test is completed, press the ESC key to exit the output test state.

Output 1 valid means output connector state is ok

9.3 Serial Port Test

Serial port test function, in a fixed baud rate (9600), data format (8-N-1) to send and receive data, to detect the serial port connection status.

Send Test: send data "COMx Test nnn". If it is serial port 1, then X=1, if there is an additional board serial port test, then X=2.

Receive test: the external sends test data (ASCII code only) to the meter and displays the data on the display. The data length of each frame cannot exceed 10 bytes.

If the external sends 30 31 41 to the meter and the meter displays as shown in the figure below, then the COM0 connection is normal.

COM0: 01A
COM1:

9.4 Analog CAL

If the transmitter is equipped with the analog expansion board, the analog output function is provided. The output mode can be selected from the parameter list (see Section 8.3). Under normal display state, press  key to view analog output. The format is: X.XXX.mA/V.

The transmitter has been calibrated on the analog output when it leaves the factory. The user does not need to calibrate the analog output. If the analog output of the transmitter

is abnormal, the user can calibrate the analog output by himself. The calibration method is as follows - take the current calibration as an example (it is recommended to conduct calibration under the guidance of a professional):

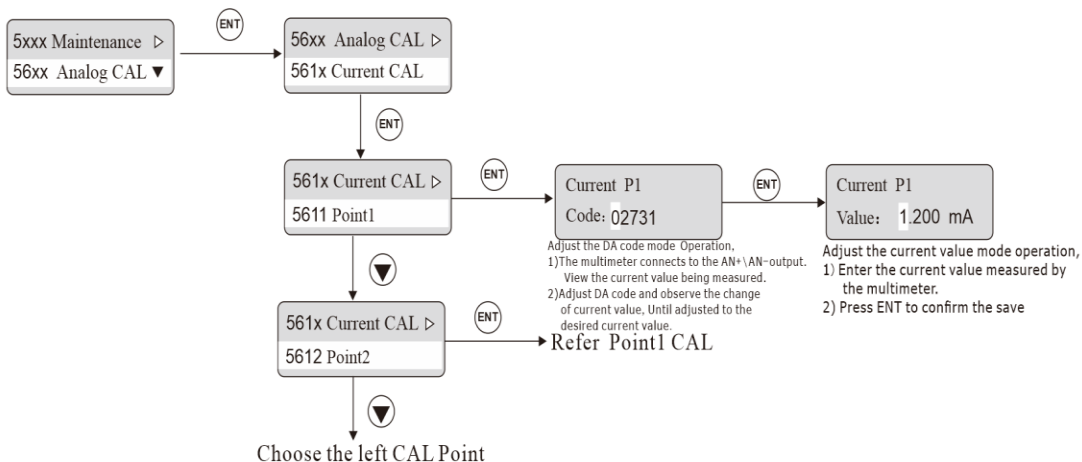

- 1) Switch to **56xx[Analog CAL]** under the parameter of **5xxx [Maintenance]**
- 2) Switch to **561x[Current CAL]**, the analog calibration can be carried out by adjusting DA code and current value.
 - i) Adjust the DA code mode, Select "Point1", press **ENT** to enter the DA code input interface, connect the multimeter to the analog output interface, and measure the current output value. The current value changes with the DA code, adjust the DA code, and observe the current value of the multimeter until it is adjusted to the required current value, that is, the calibration is complete.
 - ii) Adjusting the current value: View the current measurement value of the multimeter, press **ENT** on the DA code input interface, and modify the current output value to be consistent with the measurement value of the multimeter. The remaining points are calibrated with reference to the first point.
- 3) Current calibration supports 5-point calibration. The customer adjusts the calibration according to his needs

10. Communication protocol and address

10.1 Modbus protocol

10.1.1 Function code and exception code description

Function code

Function code	Item	Specification
03	Read register	Up to 125 single read registers
06	Write a single register	
16	Write multiple registers	This transmitter command only supports writing to the double register. When writing, the address must be aligned. It is not allowed to write only part of the double register.
01	Read the coil	Note that this length is in bits.
05	Write the coil	

Note: Only supports above Modbus function codes. When sending other function codes the transmitter will not respond.

Exception Code Respond

Code	Item	Specification
02	Illegal data address	This error code indicates that the data address received is not allowed.
03	Illegal data value	The data written is not in the allowed range.
04	Computer	An unrecoverable error occurred while the transmitter was attempting to perform the requested operation.
07	Unsuccessful programming request	For the transmitter, the command received cannot be executed under the current conditions.

10.1.2 Communication Mode

RTU

- (1) When communicating in RTU mode, every 8 bits (1 byte) in the data is divided into two 4-bit hexadecimal characters
- (2) The end of a frame should be marked with an interval of more than 3.5 characters. Recommended for a more reliable finish.

The specific protocol is as follows:

Supported data format: 8-bit data bit, 1-bit stop bit, parity check (8-E-1)

8 data bits, 1 stop bit, odd check (8-O-1)

8 data bits, 1 stop bit, no checksum (8-n-1)

Code: Binary

ASCII

When communicating in ASCII mode, every 8 bits (1 byte) in a message is transmitted as two ASCII characters

The specific agreement of this mode is as follows:

Supported data format: 7 data bits, 1 stop bit, parity check (7-E-1)

7 data bits, 1 stop bit, odd check (7-O-1)

Code: ASCII code

10.1.3 Modbus communication data sheet

PLC Address	Display Address	Specification
The Weight State Information		

40001-40002	0000-0001	Current weight value(4-byte signed integer number), When positive or negative overflows, 9999999 and -9999999 are displayed.			
40003-40004	0002-0003	Reserved			
40005	0004	Current state	Bit	Specification	
			D13-15	Reserved	※Indicates the weight tatus. When it is the current state, the status it displays "1".If the current weight is zero and stable, then the address D0D1 status bit is "1"
			D12	bipolar	
			D11	Weight is calculated using theoretical values	
			D10	ADC breakdown	
			D09	Current display NW	
			D08	Million volts stable	
			D07	Load cell -overflow	
			D06	Load cell +overflow	
			D05	Weight -overflow	
			D04	Weight +overflow	
			D03	Overflow state	
			D02	display weight -	
D01	Zero				
D00	stable				
40006	0005	Error code 1	D13-15	Reserved	
			D12	Remote calibration is performed when remote calibration is prohibited	
			D11	The calibration is in hardware protection	
			D10	The previous weight point is not calibrated	
			D09	Beyond minimum resolution	
			D08	Weight input exceeds the maximum range	
			D07	Weight input can't be 0	
			D06	Weight calibration less than zero or the previous standard point	
			D05	Load cell overflow is positive during weight calibration	
			D04	Load cell overflow is negative during weight calibration	
			D03	The weight calibration is not stable	
			D02	load cell overflow is positive during zero calibration	
			D01	load cell overflow is negative during zero calibration	
D00	The zero calibration is not stable				
40007	0006	Error code 2	D10-15	Reserved	
			D09	The remote tare operation permit switch is not enabled when the tare is operated remotely	
			D08	Net weight status does not allow tare	
			D07	Net weight status does not allow zeroing	
			D06	The remote reset switch is not turned on during remote reset	
			D05	The load cell is overflowing when zero is cleared	
			D04	Negative load cell overflow during zero clearance	
			D03	Zero clearance is unstable	
D02	Clear out of range				
D01	Unstable when reset on power				

			D00	Power on clear zero out of range
4008-40010	0007-0009	Reserved		
40011	0010	Process status flag bits	D12-D15	Reserved
			D11	Power calibration
			D10	Voltage calibration
			D09	IO testing
			D08	Printing,(valid when performing printing operations)
			D07	COMP 8 ON
			D06	COMP 7 ON
			D05	COMP 6 ON
			D04	COMP 5 ON
			D03	COMP 4 ON
			D02	COMP 3 ON
D01	COMP 2 ON			
D00	COMP 1 ON			
40012-40018	0011-0017	Reserved		
40019-40020	0018-0019	GW value(4-byte signed integer number)		
40021-40022	0020-0021	NW value(4-byte signed integer number)		
40023-40024	0022-0023	Tare weight value(4-byte signed integer number)		
40025-40026	0024-0025	Flow value(4-byte signed integer number)		
40027-40028	0026-0027	Display weight value (floating-point type)		
40029-40030	0028-0029	GW value (4-byte signed floating point number)		
40031-40032	0030-0031	NW value (4-byte signed floating point number)		
40033-40034	0032-0033	Tare weight value (4-byte signed floating point number)		
40035-40036	0034-0035	Flow value (4-byte signed floating point number)		
40037-40038	0036-0037	AD code after filtering		
40039-40040	0038-0039	Load cell volt		
40041-40042	0040-0041	Relative zero voltage value		
40043~40091	0042~0090	Reserved		
40092	0091	Input state area	Bit	Specification
			D05	Reserved
			D04	Enter 5 state (extended input 2)
			D03	Enter 4 state (extended input 1)
			D02	Enter 3 state
			D01	Enter 2 state
D00	Enter 1 state			
40093	0092	Reserved		
40094	0093	Output state area	Bit	Specification
			D09-15	Reserved
			D08	Output state 9 (extended output 4)
			D07	Output state 8 (extended output 3)
			D06	Output state 7 (extended output 2)
			D05	Output state 6 (extended output 1)
			D04	Output state 5
			D03	Output state 4
			D02	Output state 3
			D01	Output state 2
D00	Output state 1			
40095~40100	0094~0099	Reserved		
Basic parameter area, remote setting parameter 162 set to open to read and write, otherwise read only				
40101-40102	0100-0101	PWR-On Zero	0%-101% of the maximum range, default: 0	
40103-40104	0102-0103	Remote Zero ON/OFF	Range: 0 (Disable), 1 (Enable); Default: 1 (Enable)	

40105-40106	0104-0105	Zero range	1%-99% of the maximum range, default: 20%
40107-40108	0106-0107	Remote Tare	Range: 0 (Disable), 1 (Enable); Default: 1 (Enable)
40109-40110	0108-0109	Tare Record	Range: 0 (Disable), 1 (Enable); Default: 1 (Disable)
40111-40112	0110-0111	NetSign COR	Range: 0 (Disable), 1 (Correct Tare), 2 (BackToGross); Default: 0 (Disable)
40113-40114	0112-0113	Preset tare	Range: 0~ full scale. Initial values: 0
40115-40116	0114-0115	STAB Range	Range:0-99d,default 1
40117-40118	0116-0117	STAB Timer	Range:1-5000 ms,default 1000
40119-40120	0118-0119	TrZero Range	Range:0-99d,default 1
40121-40122	0120-0121	TrZero Time	Range:1-5000ms,default 1000
40123-40124	0122-0123	Digit-Filter	Range:0-9,default 4
40125-40126	0124-0125	Adv. Filter	Range:0-99d,default 0
40127-40128	0126-0127	AD Sample Rate	Range:0-9 (corresponding 0-50; 1-60; 2-100; 3-120; 4-200; 5-240; 6-400; 7-480; 8-800; 9-960) default 4; 200Hz
40129-40130	0128-0129	Input Range	Range:0-5 (corresponding 0: 0-5mV; 1: 0-10mV; 2: 0-15mV, 3: -5-5mV; 4: -10-10mV; 5: -15-15mV) default: 1 (0-10mV)
40131~40200	0130~0199	Reserved	
40201-40202	0200-0201	Unit	Range:0-3; 0-t, 1-kg, 2-g, 3-lb
40203-40204	0202-0203	Decimal	Range: 0-4; 0-0, 1-0.0, 2-0.00, 3-0.000, 4-0.0000
40205-40206	0204-0205	Division	Range: 1, 2, 5, 10, 20, 50, 100, 200, 500
40207-40208	0206-0207	Full Scale	Range:0-999999.
40209-40210	0208-0209	Reserved	
40211-40212	0210-0211	Auto Capture	Only write 1; write 1, Performs zero calibration of the current state. Fix four decimal places
40213-40214	0212-0213	Key In mV	Range:0-150000; Write millivolts
40215-40216	0214-0215	Weight CP1	Write the weight value to the calibration weight point 1 calibration
40217-40218	0216-0217	Weight CP2	Write the weight value to the calibration weight point 2 calibration
40219-40220	0218-0219	Weight CP3	Write the weight value to the calibration weight point 3 calibration
40221-40222	0220-0221	Weight CP4	Write the weight value to the calibration weight point 4 calibration
40223-40224	0222-0223	Weight CP5	Write the weight value to the calibration weight point 5 calibration
40225-40226	0224-0225	LC mV/V	Write the actual sensitivity of the load cell for the theoretical value calibration
40227-40228	0226-0227	LC Capacity	Write the total range of the load cell for theoretical calibration
40229-40230	0228-0229	Use T-CAL	Write 1 to enable theoretical value calibration, write 0 to use calibration data
40231-40232	0230-0231	Correct Coef	Write the coefficient to modify the calibration, write the data integer type, the system default data write data with 5 decimal point
40233-40234	0232-0233	Flow SampleWindow	Range:1000-60000. Write 10000 equivalent to setting to 10.000s
40235-40236	0234-0235	Max Flowrate	Range: 0-999999. Sets the maximum amount of flow
40237-40238	0236-0237	FlowrateUint	Range:0-1; 0: Hour, 1: Minute
40239~40300	0238~0299	Reserved	
Apply parameter area, address range 4x00301-4x08000.The remote setting (352X) is read-write when enabled, otherwise read-only			
40301-40302	0300-0301	Select Mode	Comp. Mode; Only read.
40303-40304	0302-0303	Input1 function	Comp. Mode: parameter range 0-8, 0-no function, 1-zero,

			2- Cal-Zero, 3-tare, 4-clear tare, 5- GROSS/NET, 6- COMP-ON, 7-PRINT, 8- P EMPTY LINE.
40305-40306	0304-0305	Input1 mode	Range: 0-1, 0: Low level, 1: High level
40307-40308	0306-0307	Input1 Delay	Comp. Mode: parameter range 0ms-200ms, default 5ms.
40309-40310	0308-0309	Input2 function	Refer to input 1 function description
40311-40312	0310-0311	Input2 mode	Refer to input 1 mode description
40313-40314	0312-0313	Input2 Delay	Refer to input 1 Delay description
40315-40316	0314-0315	Input3 function	Refer to input 1 function description
40317-40318	0316-0317	Input3 mode	Refer to input 1 mode description
40319-40320	0318-0319	Input3 Delay	Refer to input 1 Delay description
40321-40322	0320-0321	ExIN1 Function	Refer to input 1 function description, can write when there is IO attached board, otherwise read only
40323-40324	0322-0323	ExIN1 Mode	Refer to input 1 mode instructions, only when there is IO attached board can write, otherwise read only
40325-40326	0324-0325	ExIN1 Delay	Refer to input 1 to shake instructions, IO attached board can only write, otherwise read only
40327-40328	0326-0327	ExIN2 Function	Refer to input 1 function description, can write when there is IO attached board, otherwise read only
40329-40330	0328-0329	ExIN2 Mode	Refer to input 1 mode instructions, only when there is IO attached board can write, otherwise read only
40331-40332	0330-0331	ExIN2 Delay	Refer to input 1 to shake instructions, IO attached board can only write, otherwise read only
40333-40334	0332-0333	OUT1 Function	Range 0-14, Correspondence: Nonfunctional, Stable, Zero, Net Weight, Printing, Negative Weight, Communications Heart-beat, Comparator 1, Comparator 2...The comparator 8
40335-40336	0334-0335	OUT1 Mode	Range:0-1, 0: low output, 1: high output
40337-40338	0336-0337	OUT2 Function	Refer to the output 1 function
40339-40340	0338-0339	OUT2 Mode	Refer to the output 1 pattern
40341-40342	0340-0341	OUT3 Function	Refer to the output 1 function
40343-40344	0342-0343	OUT3 Mode	Refer to the output 1 pattern
40345-40346	0344-0345	OUT4 Function	Refer to the output 1 function
40347-40348	0346-0347	OUT4 Mode	Refer to the output 1 pattern
40349-40350	0348-0349	OUT5 Function	Refer to the output 1 function
40351-40352	0350-0351	OUT5Mode	Refer to the output 1 pattern
40353-40354	0352-0353	Ext.OUT1 Function	Refer to the output 1 function
40355-40356	0354-0355	Ext.OUT1 Mode	Refer to the output 1 pattern
40357-40358	0356-0357	Ext.OUT2 Function	Refer to the output 1 function
40359-40360	0358-0359	Ext.OUT2 Mode	Refer to the output 1 pattern
40361-40362	0360-0361	Ext.OUT3 Function	Refer to the output 1 function
40363-40364	0362-0363	Ext.OUT3 Mode	Refer to the output 1 pattern
40365-40366	0364-0365	Ext.OUT4 Function	Refer to the output 1 function
40367-40368	0366-0367	Ext.OUT4 Mode	Refer to the output 1 pattern
40369-40500	0368-0499	Reserved	
40501-40502	0500-0501	COMP 1- Comp. Mode	Initial value: 1:(W<=CV1),Range:0-12 0:(OFF);1:(W<=CV1);2:(W=CV1);3:(W!=CV1);4 (W>=CV1);5:(CV1<=W<=CV2);6:(W <[CV1,CV2]>W);7:(F<=CV1); 8:(F=CV1);9 (F!=CV1); 10:(F>=CV1);11:(CV1<=F <=CV2); 12:(F <[CV1,CV2]> F)
40503-40504	0502-0503	COMP 1- CompValue 1	Comp. Mode: CompValue 1, directed number, range: -999999-999999.
40505-40506	0504-0505	COMP 1- CompValue 2	Comparing patterns: CompValue 2, directed number, range:-999999-999999. > CompValue 1
40507-40508	0506-0507	COMP 1- ON COND.	Range: 0-2, correspond to: 0:Immediately; 1:Stable;

			2:Debounce mode
4050940510	0508-0509	COMP 1- TRUE JudgeT	minimum decision time for success, range 0-50000ms , default 1000
4051140512	05100511	COMP 1- OFF COND.	Range: 0-2 , correspond to: 0:Immediately; 1:Stable; 2:Debounce mode
40513-40514	0512-0513	COMP 1- FALSE HoldT	Mini failure timer, range 0-50000ms , default 1000
40515-40520	0514-0519	Reserved	
40521-40540	0520-0539	COMP2 parameter	Refer to comparator 1 parameters
40541-40560	0540-0559	COMP3 parameter	
40561-40580	0560-0579	COMP4 parameter	
40581-40600	0580-0599	COMP5 parameter	
40601-40620	0600-0619	COMP6 parameter	
40621-40640	0620-0639	COMP7 parameter	
40341-40660	0640-0659	COMP8 parameter	
40661~48000	0660~7999	Reserved	
Communication parameter setting area, Remote Settings (482X) are read-write when enabled, otherwise read-only			
48001	8000	COM0 ID	COM 0 COM0 ID; Range: 01-99
48002	8001	COM0 Baudrate	Range: 0-7 correspond to: 1200, 2400, 4800, 9600, 19200, 38400, 57600, 115200 ; Initial value 5 (38400)
48003	8002	COM0 Protocol	Including: 0-Modbus/RTU, 1-Modbus/Ascii, 2-Cont-A, 3-Cont-B, 4-r-Cont, 5-rE-Cont, 6-YH, 7-print , default 0 (Modbus/RTU)
48004	8003	COM0 Data Format	Range: 0-8N1, 1-8E1, 2-8O1, 3-7E1, 4-7O1 Initial value: 1 (8E1)
48005	8004	COM0 DwordFormat	0-AB-CD, 1-CD-AB . Initial value: 0 (AB-CD)
48006	8005	COM0 Send Gap	Range 0-1000ms , default: 20ms
48007~48020	8006~48019	Reserved	
48021	8020	COM1 ID	Refer COM0 parameters
48022	8021	COM1 Baudrate	
48023	8022	COM1 Protocol	
48024	8023	COM1 Data Format	
48025	8024	COM1 DwordFormat	
48026	8025	COM1 Send Gap	
48027	8026	COM1 1-RS485; 0-RS232	
48028~48040	8027~8039	Reserved	
48041	8040	COM2 ID	Refer COM0 parameters
48042	8041	COM2 Baudrate	
48043	8042	COM2 Protocol	
48044	8043	COM2 Data Format	
48045	8044	COM2 DwordFormat	
48046	8045	COM2 Send Gap	
48047~48100	8046~8099	Reserved	
48101	8100	NetCOM Protocol	Protocol: 0-Modbus/TCP When choose Ethernet/IP, Profinet , this parameter can't be set
48102	8101	NetCOM DWord-Format	NetCom can set: 0-AB-CD, 1-CD-AB When choose Ethernet/IP, Profinet , this parameter can't be set.
48103	8102	NetCOM Send Gap	This parameter is used to set the interval between successive transmissions. Range: 0-1000ms
48104-48107	8103-8106	IP Config	The order is Part I to Part IV IP

48108-48111	8107-8110	DEST. IP	The order is Part I to Part IV IP
48112	8111	Socket	Range:0-65535, Network communication port number setting
48113	8112	NetCOM DEST. IP	Range:0-65535, Network communication port number setting
48114-48150	8113-8149	Reserved	
48151	8150	Analog output mode	0: 4-20mA; 1: 0-10V; 2: User voltage; 3: User current
48152	8151	Analog Min output	Range:0-10000 or 0-24000, default 0. If it is not user mode, the readout will be 0 and the write will be invalid.
48153	8152	Zero analog output	Range:0-10000 or 0-24000, default 0. If it is not user mode, the readout will be 0 and the write will be invalid.
48154	8153	full range analog output	Range:0-10000 or 0-24000, default 0. If it is not user mode, the readout will be 0 and the write will be invalid
48155	8154	Analog Max output	Range:0-10000 or 0-24000, default 0. If it is not user mode, the readout will be 0 and the write will be invalid
48156	8155	Analog Link Data	0: DisplayWt,1: Net,2: Gross,3: FlowRate
48157-48200	8156-8199	Reserved	
48201	8200	HeaderLines	Range:0-4, select how many headerlines to use
48202	8201	EndLines	Range:-4, select how many endlines to use
48203	8202	Ticket Gap	Range:0-99, No. of lines between each print
48204	8203	Content	Range:0-6, option: 0:display weight,1:Gross, 2:NW,3:flowrate,4:NW+ Gross (2 LINES) ,5:Gross + flowrate,6:All info (Gross +NW+ flowrate) ;default 0.
48205	8204	Print Language	0: English; 1: Chinese
48206	8205	Lines choose	Range:1-8, For header information 1-4 and tail information 1-4. It's going to be 0 when you put it on.After writing, read out is the value written
48207-48222	8206-8221	Character content of the printed message (16 characters)	Support: 0-9, a-z, A-Z, ' space ', "- Ascii code
48221~48250	8222~8249	Reserved	
48251-48256	8250-8255	Blue tooth Device Name 6 characters	Only support: 0-9, a-z, A-Z, ' space ', "- Ascii code
48257~48280	8256~8279	Reserved	
48281	8280	Language	0: Chinese; 1: English
48282~48300	8281~8299	Reserved	
Transmitter test area that allows remote testing (523X) to be read and write, otherwise read only			
48301	8300	I/O test	Parameters range: 0-1, 0: Exit I/O test mode, 1: enter serial port IO test mode, must be closed after the end of the test, the transmitter can enter the normal state.
48302	8301	Input1 TEST	Reading 0 means no input and reading 1 means there is input.Any value written is invalid and only valid in IO test mode
48303	8302	Input2 TEST	
48304	8303	Input3 TEST	
48305	8304	Ext.IN1 test	
48306	8305	Ext.IN2 test	
48307~48350	8306~8349	Reserved	
48351	8350	Output1 test	Range: 0-1, write: 0, close output, 1:output ON (only valid in IO test mode) ,read out current IO state, 0: OFF, 1: ON
48352	8351	Output2 test	
48353	8352	Output3 test	
48354	8353	Output4 test	
48355	8354	Output5 test	
48356	8355	Ext.OUT1 test	
48357	8356	Ext.OUT2 test	

48358	8357	Ext.OUT3 test	
48359	8358	Ext.OUT4 test	
48360~48400	8359~8399	Reserved	
Analog calibration area address, allow remote editing (594X) can read and write, otherwise read only			
48401	8400	IN/OUT Analog CAL	Range: 0-2 , write: 0 , ESC remote analogue CAL state; 1 : Remote current CAL; 2 : Remote vlot CAL. Remote edit (584x) Use after start.
48402	8401	Current CALPoint1 digital code	Digital Code;Range: 0-65535 , Write: Meter outputs current according to write code. Available only in current calibration mode. Current value;Range: 0-24000 , write the measured current value, complete the current calibration of the corresponding point. Available only in current calibration mode.
48403	8402	Current CAL Point1Current value	
48404	8403	Current CAL Point2 digital code	
48405	8404	Current CAL Point2 current value	
48406	8405	Current CAL Point3digital code	
48407	8406	Current CAL Point3 current value	
48408	8407	Current CAL Point4digital code	
48409	8408	Current CAL Point4 current value	
48410	8409	Current CAL Point5 digital code	
48411	8410	Current CAL Point5 current value	
48412	8411	Voltage CAL Point1 digital code	Digital Code;Range: 0-65535, Write: Meter outputs voltage according to write code. Available only in voltage calibration mode. Voltage Value;Range: 0-10000, write the measured voltage value, complete the voltage calibration of the corresponding point. Available only in voltage calibration mode.
48413	8412	Voltage CAL Point1 voltage value	
48414	8413	Voltage CAL Point2 digital code	
48415	8414	Voltage CAL Point2 voltage value	
48416	8415	Voltage CAL Point3 digital code	
48417	8416	Voltage CAL Point3 voltage value	
48418	8417	Voltage CAL Point4 digital code	
48419	8418	Voltage CAL Point4 voltage value	
48420	8419	Voltage CAL Point5 digital code	
48421	8420	Voltage CAL Point5 voltage value	
48422~48600	8421~8599	reserved	
Function operation class address area (corresponding to the coil function), condition can read and write			
48601	8600	ZERO	Write 1 to perform the corresponding Read 0
48602	8601	TARE	
48603	8602	CLEAR TARE	
48604	8603	GW/NW	
48605	8604	ZEROING	
48606	8605	PRINT	
48607	8606	P EMPTY LINE	
48608~48900	8607~8899	Reserved	
48901	8900	All parameter reset	Write 1 to perform the corresponding reset operation. read out is 0
48902	8901	Part parameter reset (All do not include calibration)	
48903	8902	Cal Reset	
48904	8903	Basic parameter reset	
48905	8904	I/O define reset	
48906	8905	DA Cal RST.	
48907	8906	App Reset	
48908	8907	Reset	
48908~48980	8907~8979	Reserved	
48981-48988	8980-8987	Edit the boot LOGO character 1-8 (8 characters)	The sequence corresponds to the 1-8 characters of the boot logo. ASCII code should be written in the range of 0-9,A-Z, A-Z, and space, ' '
48989~49000	8988~8999	Reserved	
Transmitter system information area, read-only area			

410001	10000	Version (Hi word)	
410002	10001	Version (Lo word)	Read out 10000, 01.00.00 ver.
410003	10002	Edit time (year)	
410004	10003	Edit time (Month/Day)	
410005-410017	10004-10016	The transmitter serial number is 13 characters	
410018-410029	10017-10028	The transmitter encodes 12 characters	
410030	10029	Reserved	
410031-410040	10030-10039	The transmitter models have 10 characters	
410041	10040	Additional board 01 information	
410042	10041	Additional board 02 information	
410043-410100	10042-10099	Reserved	
410101-410106	10100-10105	NetCom 0 transmitter MAC address	
410107-410112	10106-10111	NetCom 1 transmitter MAC address	
410113-410118	10112-10117	Blue tooth Mac address	
410119-410150	10118-10149	Reserved	
410151	10150	ScreenSleep	Range:0-3600s, Default: 600s
410152	10151	COM LED	Range: 0-3, 0: COM0 , 1: COM1, 2: COM2, 3: NetCOM,4:CAN
410153	10152	WT Data Type	Range: 0-1, 0:Float, 1:Int, Default: Float, This parameter is available only when the PN /EIP/CCLink-IE/ EtherCAT firmware is used, but not when the standard network port mode is used.
410154-410200	10153-10199	Reserved	
410201	10200	Basic parameter remote edit	Switch Status bit, READY ONLY: READ OUT: 0:OFF;1:ON
410202	10201	Basic parameter PWD Protect	
410203	10202	Remote CAL	
410204	10203	CAL hardware protect	
410205	10204	CAL PWD Protect	
410206	10205	Application parameter remote	
410207	10206	Application parameter PWD Protect	
410208	10207	Communication parameter remote edit	
410209	10208	Communication parameter PWD Protect ON/OFF	
410210	10209	Remote editing of system maintenance parameters	
410211	10210	System maintenance parameters are password protected	
Coil address			
0x0001	0000	ZERO	Content read and write coil Write ON valid Read as 0
0x0002	0001	TARE	
0x0003	0002	CLEAR TARE	
0x0004	0003	GROSS/NET	
0x0005	0004	ZEROING	
0x0006	0005	PRINT	
0x0007-0x0300	0006-0299	Reserved	
0x0301	0300	All parameter reset	WRITE ONLY If the write ON is valid, reset is performed Read as 0
0x0302	0301	Part parameter reset	
0x0303	0302	CAL reset	
0x0304	0303	Basic parameter reset	
0x0305	0304	I/O define reset	
0x0306	0305	Analog CAL reset	
0x0307	0306	Application parameter reset	
0x0308	0307	Communication parameter reset	
0x0309-0x0400	0308-0399	Reserved	

0x0401	0400	IN1 STATE	READ Only Readout returns an input port state 0: invalid; 1:valid
0x0402	0401	IN2 STATE	
0x0403	0402	IN3 STATE	
0x0404	0403	Ext. IN1 STATE	
0x0405	0404	Ext. IN2 STATE	
0x0406~0x0450	0405~0449	Reserved	
0x0451	0450	OUT1 STATE	READ Only Readout returns an output port state 0: invalid; 1:valid
0x0452	0451	OUT2 STATE	
0x0453	0452	OUT3 STATE	
0x0454	0453	OUT4 STATE	
0x0455	0454	OUT5 STATE	
0x0456	0455	Ext. OUT1 STATE	
0x0457	0456	Ext. OUT2 STATE	
0x0458	0457	Ext. OUT3 STATE	
0x0459	0458	Ext. OUT4 STATE	
0x0460~0x0500	0459~0499	Reserved	
0x0501	0500	Remote edit (basic parameter)	Read Only Parameter
0x0502	0501	PWD Protect (basic parameter)	
0x0503	0502	Remote CAL (CAL parameter)	
0x0504	0503	HWD. Protect (CAL parameter)	
0x0505	0504	PWD Protect (CAL parameter)	
0x0506	0505	Remote edit (Application parameter)	
0x0507	0506	PWD Protect (Application parameter)	
0x0508	0507	Remote edit (Communication parameter)	
0x0509	0508	PWD Protect (Communication parameter)	
0x0510	0509	Remote edit (Maintenance parameter)	
0x0511	0510	PWD Protect (Maintenance parameter)	
0x0512~0x0800	0511~0799	Reserved	

10.2 Continuous send A (CB920)

When GMT-X1 serial port protocol choose "Continuous send A (CB920)" send data according to below format.

State	0	Content	0/1	+/-	display value	Unit	CR	LF
2 bytes	30	2 bytes	30/31	2B/2D	7 bytes	2 bytes	0D	0A

State—— 2 bytes, **OL:** (4FH 4CH) overflow; **ST:** (53H 54H)stable; **US:** (55H 53H)unstable

Gross—— 2 bytes, **GS(gross):**47H 53H; **NT(net weight):**4EH 54H;**FR(floware):**46H 52H

0/1—— 1 byte,(30H/31H) interleave send.

unit—— 2 bytes, **kg: 6BH 67H; G: 20H 67H etc**

Eg: When the transmitter automatically sends folling data.

53 54 30 47 53 30 2B 20 20 20 20 32 35 34 6B 67 0D 0A

It can be known that the current transmitter state is stable, gross weight, data value is positive, and current weight value is **254 kg**

10.3 Cont-B (Continuous send -tt)

When GMT-X1 serial port protocol is selected as "continuous transmission B (tt)", the collected data will be automatically sent to the master computer

STX	State1	State 2	State 3	Display value	Load cell voltage	CR	CheckSum
02H	1 byte	1 byte	20H	6 bytes	6 bytes	0D	1 byte

Status 1:

bit7	bit6		bit5	bit4		bit3	bit2		bit1	bit0
Fix 0	/h	1	0	t	0	0	0	0	1	0
	/m	1	1	Kg	0	1	0.0	0	1	1
				g	1	0	0.00	1	0	0
				Lb	1	1	0.000	1	0	1
							0.0000	1	1	0
Flow unit			Weight Unit			Decimal				

Status 2:

bit7	bit6	bit5	bit4	bit3	bit2	bit1	bit0
Reserved	Reserved	Reserved	1- Flow	1-Unstable	1-overflow	1-negative	1-NT
Fix 0	Fix 1	Fix 1	0- Weight	0-stable	0-normal	0-positive	0-Gross

10.4 r-Cont

When **GMT-X1** serial port protocol choose “**r-Cont**”, Without sending any command to the weight transmitter, the data collected will be automatically sent to the computer in the following format.

STX	Scale No.	Channel No.	State1	State2	Display value	CRC	CR	LF
02H	2 bytes	31H	1 byte	1 byte	6 bytes	2 bytes	0D	0A

Scale No.-----2 bytes, range 01~99

State1-----1 byte

bit7	bit6		bit5	bit4		bit3	bit2		bit1	bit0
Fix0	/h	1	0	t	0	0	0	0	0	0
	/m	1	1	Kg	0	1	0.0	0	0	1
				g	1	0	0.00	0	1	0
				Lb	1	1	0.000	0	1	1
							0.0000	1	0	0
Flow unit			Weight Unit			Decimal				

State2-----1 byte

D6	D5	D4	D3	D2	D1	D0
No define	No define	Gross/NET	+/-	0	overflow	Stable
FIX:1	FIX:0	Gross 0; NET 1;	0: + 1: -	0: non 0 1: 0	0: normal 1: overflow	0: UnStable 1: Stable

Weight Value —— 6- bytes unsigned number;Returns "blank space OFL space" when weight is positive (negative) overflow.

CRC—— 2 bytes, CheckSum

All the values in front of the check bits are added up and converted to decimal data, and then the last two bits are converted to ASCII (tens before, ones after).

For example:If there is one of the following frames:

02	30	31	43	47	4F	4B	39	31	0D	0A
----	----	----	----	----	----	----	----	----	----	----

The sum of 02~4B is 187 (Hex), which is converted to decimal as 391.It can be calculated that the check codes of this data frame are 39 and 31

Example:

The current transmitter automatically returns data: **02 30 31 31 40 41 20 20 20 37 30 30 32 34 0D 0A**

The current transmitter state is stable, the weight value is positive, and the current weight value is 700.

10.5 rE-Cont

In this way, no need to send any command to the weighing display, and the display will automatically send the collected data to the computer

Return data frame format description:

State	,	Content	,	+/-	Display value	Unit	CR	LF
2 bytes	2C	2 bytes	2C	2B/2D	7 bytes	2 bytes	0D	0A

State——2 bytes, **OL**(Overflow):**4FH 4CH**; **ST** (stable):**53H 54H**; **US** (Unstable):**55H 53H**

Content——2 bytes, **GS**(Gross weight): **47H 53H** ; **NT**(Net weight): **4EH 54H**;
FR(floware): **46H 52H**

Display value—— 7 bytes, Include Decimal, When no Decimal, high way is empty

Unit—— 2 bytes, **kg**: **6BH 67H**; **g**:**20H 67H** etc

Eg:

When the weighing display automatically sends the following frame of data:

53 54 2C 47 53 2C 2D 20 20 20 20 32 36 37 20 74 0D 0A

The current state is stable, the data value is positive, and the display value is -267t.

10.6 YH Protocol

When **GMT-X1** serial port protocol choose “**YH** protocol” , Transfer data in the following format.Under this protocol, the data is output in ASCII code, and each frame consists of 9 groups (including the decimal point).Data transmission starts with low and then high. There is a set of delimiter "=" between each frame of data. The data sent is gross weight, such as the current gross weight of 70.15, continuous transmission of 51.0700=51.0700...

Eg: **123.9**

Bit0	Bit1	Bit2	Bit3	Bit4	Bit5	Bit6	Bit7	Bit8
=	9	.	3	2	1	0	0	0

High point is not enough to fill 0, the decimal point accounts for 1 byte, and when a negative number is negative, Bit8 is a negative sign "-".

10.7 PROFINET Protocol

The **GMT-X1** display has two PROFINET-IO bus connection ports, NET1 and NET2, which can be used as a PROFINET-IO slave station to connect to the PROFINET bus.

IP address of instrument is set and viewed in parameter item 444X; The MAC address is viewed in item 571x.

10.7.1 IO state

GMT-X1 provides multi-byte IO through which the master station can read and control the status of the weighing display.In PN communication mode, two versions of I/O module addresses are provided: standard edition and compact edition. By Network port Parameter 447x you can select the version. The I/O module addresses of the two versions are as follows:

10.7.1.1 Standard IO module address

Module1: Weight and status parameters (read register)

Offsets	Parameter	Data type	Description
0	Display weight	DInt	The current weight of the display, integral type, When positive or negative overflows, 9999999 and -9999999 are displayed.

4	Weight status marker bit	Word	D13-D15 Reserved
			D12: bipolar, (When bipolar is selected, the flag bit is valid)
			D11: Calculate the weight using the theoretical value (prompt the user when calculating the weight using the theoretical value)
			D10: ADC failure (ADC initialization failure or sampling interruption longer than expected)
			D9: Net weight of the current display, (distinguish which weight is currently displayed)
			D8: Million volt stability, (mark of million volt stability in calibration)
			D7: Negative load cell overflow, lower than the allowable range of load cell voltage
			D6: The load cell is overflowing, beyond the allowable range of load cell voltage
			D5: Weight negative overflow, weight less than "-(maximum range + 9D)"
			D4: The weight is positive overflow, the weight is greater than "maximum range + 9D"
			D3: Overflow state, (weight or load cell abnormality)
			D2: Display weight minus sign, (display weight is a negative number)
			D1: Zero, (weight in the range of 0+/- 1/4 D)
D0: Stable			
6	Error code 1	Word	D13-D15 Reserved
			D12: Remote calibration is performed when remote calibration is prohibited
			D11: The calibration is in hardware protection
			D10: The previous weight point is not calibrated
			D09: Beyond the minimum resolution (less than 0.1uV per subdivision)
			D08: Weight input exceeds the maximum range
			D07: The weight input cannot be zero
			D06: Weight calibration less than zero or the previous standard point
			D05: Load cell overflow is positive during weight calibration
			D04: Negative load cell overflow during weight calibration
			D03: The weight calibration is not stable
			D02: Load cell overflow is positive during zero calibration
			D01: Negative load cell overflow during zero calibration
D00: The zero calibration is not stable			
8	Error code 2	Word	D14-D15 Reserved
			D13: The remote tare operation permit switch is not enabled when the tare is operated remotely
			D12: Net weight status does not allow tare
			D11: When tare, the weight is negative
			D10: Load cells overflow when tare
D09: Negative load cell overflow during tare			

			D08: Unstable when tare
			D07: The net weight status is not allowed to be cleared
			D06: The remote reset switch is not turned on during remote reset
			D05: The load cell is overflowing when zero is cleared
			D04: Negative load cell overflow during zero clearance
			D03: Zero clearance is unstable
			D02: Clear out of range
			D01: Unstable when reset on power
			D00: Power on clear zero out of range
10	Process status flag bits	Word	D13-D15 Reserved
			D11: Current calibration under way
			D10: Voltage calibration under way
			D9: IO Testing state
			D8: In printing, (valid when the meter is performing printing operation)
			D7: The comparator 8 reaches, (the comparison condition is valid if the comparator 8 reaches)
			D6: The comparator 7 reaches, (the comparison condition is valid if the comparator 7 reaches)
			D5: The comparator 6 reaches, (the comparison condition is valid if the comparator 6 reaches)
			D4: The comparator 5 reaches, (the comparison condition is valid if the comparator 5 reaches)
			D3: The comparator 4 reaches, (the comparison condition is valid if the comparator 4 reaches)
			D2: The comparator 3 reaches, (the comparison condition is valid if the comparator 3 reaches)
			D1: The comparator 2 reaches, (the comparison condition is valid if the comparator 2 reaches)
			D0: The comparator 1 reaches, (the comparison condition is valid if the comparator 1 reaches)
12	Gross	DInt	Gross value (Signed integers)
16	Net weight	DInt	Net weight value (Signed integers)
20	Tare	DInt	Tare value (Signed integers)
24	Flow	DInt	Flow value (Signed integers)
28	Current weight	Float	Current display weight, floating-point type
32	Gross	Float	Gross value, floating-point type
36	Net weight	Float	Net weight value, floating-point type
40	Tare	Float	Tare value, floating-point type
44	Flow	Float	Flow value, floating-point type
48	AD code after filtering	DWord	AD code after filtering
52	Sensor voltage data	DWord	Signed numbers, integers, four decimal points
56	Relative zero voltage value data	DWord	Signed numbers, integers, four decimal points
60	Input state area	Word	D5-D15 Reserved
			D4: Enter 5 state (Expand input 2)
			D3: Enter 4 state (Expand input 1)
			D2: Enter 3 state
			D1: Enter 2 state
			D0: Enter 1 state

62	Output state area	Word	D9–D15 Reserved
			D8: Output 9 state (Expand input 4)
			D7: Output 8 state (Expand input 3)
			D6: Output 7 state (Expand input 2)
			D5: Output 6 state (Expand input 1)
			D4: Output 5 state
			D3: Output 4 state
			D2: Output 3 state
			D1: Output 2 state
D0: Output 1 state			
64	Heartbeat communication	DWord	After the connection is established, the value of the communication heartbeat of the PN will also be converted between 0 and 1 at the frequency of 1 Hz.

Module2: Calibration parameters (read/write register)

Offsets	Parameter	Data type	Description	
0	Automatic zero	DWord	Current sensor voltage	Read the register
4	Gain point 1	DWord	Relative voltage value 1 (loadcell input - zero voltage)	
8	Gain point 2	DWord	Relative voltage value 2 (loadcell input - 1 voltage at reference point)	
12	Gain point 3	DWord	Relative voltage value 3 (loadcell input -2 voltage at reference point)	
16	Gain point 4	DWord	Relative voltage value 4 (loadcell input - 3 voltage at reference point)	
20	Gain point 5	DWord	Relative voltage value 5 (loadcell input - 4 voltage at reference point)	
0	Automatic zero	DWord	Current loadcell voltage (write 1 to the communication address to perform automatic acquisition of zero calibration)	Write register (address write value to complete calibration)
4	Gain point 1	DWord	Input gain weight value 1	
8	Gain point 2	DWord	Input gain weight value 2	
12	Gain point 3	DWord	Input gain weight value 3	
16	Gain point 4	DWord	Input gain weight value 4	
20	Gain point 5	DWord	Input gain weight value 5	
24	Function state	DWord	D7-D31 Reserved	
			D6: P EMPTY LINE	
			D5: Print	
			D4: Cal zero	
			D3: Gross/Net weight	
			D2: Clear Tare	
			D1: Tare	
D0: Zero				

Module3: parameters revise (read/ write register)

0	Read out value	DWord	The value obtained by writing the address to be read	read register
4	Write status	Word	Write data return status 0: no error 1: register address illegal 2: parameter error	
6	Read status	Word	Read data return status 0: no error 1: register address illegal 2: parameter error	
0	The request to write value of	DWord	Address to be written (Note If the address changes, it will not be written) Modifiable Interface modules support MODBUS addresses ranging from 100	write register

	the modbus address		to 660.	
4	Input value	DWord	Data to be written (Note only written to the transmitter if the value changes)	
8	The read request of the modbus address	DWord	Address to be read (Note cannot read a Dword address write an odd address) Modifiable Interface modules support MODBUS addresses ranging from 0 to 660.	

10.7.1.2 Simple IO module address

PN cycle parameter list

Offsets	Parameters	Data type	Description
Read register (I address)			
0	Display value	Dword	current display weight, integer, When positive or negative overflows, 9999999 and -9999999 are displayed.
4	Weight status marker bit	Word	D13-D15 Reserved
			D12: bipolar
			D11: Weight is calculated using theoretical values
			D10: ADC breakdown
			D9: Current display NW
			D8: Million volts stable
			D7: Load cell -overflow
			D6: Load cell +overflow
			D5: Weight -overflow
			D4: Weight +overflow
			D3: Overflow state
			D2: display weight -
D1: Zero			
D0: stable			
6	Error code 2	Word	D14-D15 Reserved
			D13: The remote tare operation permit switch is not enabled when the tare is operated remotely
			D12: Net weight status does not allow tare
			D11: When tare, the weight is negative
			D10: Load cells overflow when tare
			D09: Negative load cell overflow during tare
			D08: Unstable when tare
			D07: The net weight status is not allowed to be cleared
			D06: The remote reset switch is not turned on during remote reset
			D05: The load cell is overflowing when zero is cleared
			D04: Negative load cell overflow during zero clearance
			D03: Zero clearance is unstable
D02: Clear out of range			
D01: Unstable when reset on power			
D00: Power on clear zero out of range			
8	Sensor voltage data	DWord	Signed numbers, integers, four decimal points
12	Read out value	DWord	The value obtained by writing the address to be read

16	Write status	Word	Write data return status 0: no error 1: register address illegal 2: parameter error
18	Heartbeat communication	Word	After the connection is established, the value of the communication heartbeat of the PN will also be converted between 0 and 1 at the frequency of 1 Hz
Write register (Q address)			
0	functional operation	DWord	D7-D31 Reserved
			D6: P_EMPTY_LINE
			D5: Print
			D4: Cal zero
			D3: Gross/Net weight
			D2: Clear Tare
			D1: Tare
			D0: Zero
4	The request to write value of the modbus address	DWord	Write value address. (Note: that a change in address does not write)This PARA modify connect port module support MODBUS address range from 100 to 660.
8	Input value	DWord	Input value to the request to write value of the modbus address (Note: only when value change will write in transmitter)
12	The read request of the modbus address	DWord	Read address (Note: Can't read DWord address, when write an odd address) This PARA modify connect port module support MODBUS address ranging from 0 to 660 .

10.7.2 Device description file GSD

The device description file and connection method of GMT-X1 can be downloaded from the website of Shenzhen General Measure Technology Co., Ltd. (www.gmweighing.com).

10.8 EtherNet-IP Protocol

IP address of controller is set and viewed in parameter item 444X; The MAC address is viewed in item 571x.

10.8.1 IO state

GMT-X1 has two type of EDS file. One is full version with 100 bytes input and 40 bytes output, another is simplified version with 20 bytes input and 16 bytes output. The master station can read and control the status of the load display through these I/O.

10.8.1.1 Standard IO module address

Module 1: Weight and status parameters (read register)

Offsets	Parameter	Data type	Description
0	Display weight	DInt	The current weight of the display, integral type, When positive or negative overflows, 9999999 and -9999999 are displayed.
2	Weight status marker bit	Word	D13-D15 Reserved
			D12: bipolar, (When bipolar is selected, the flag bit is valid)

			<p>D11: Calculate the weight using the theoretical value (prompt the user when calculating the weight using the theoretical value)</p> <p>D10: ADC failure (ADC initialization failure or sampling interruption longer than expected)</p> <p>D9: Net weight of the current display, (distinguish which weight is currently displayed)</p> <p>D8: Million volt stability, (mark of million volt stability in calibration)</p> <p>D7: Negative load cell overflow, lower than the allowable range of load cell voltage</p> <p>D6: The load cell is overflowing, beyond the allowable range of load cell voltage</p> <p>D5: Weight negative overflow, weight less than "- (maximum range + 9D)"</p> <p>D4: The weight is positive overflow, the weight is greater than "maximum range + 9D"</p> <p>D3: Overflow state, (weight or load cell abnormality)</p> <p>D2: Display weight minus sign, (display weight is a negative number)</p> <p>D1: Zero, (weight in the range of 0+/- 1/4 D)</p> <p>D0: Stable</p>
3	Error code 1	Word	<p>D13-D15 Reserved</p> <p>D12: Remote calibration is performed when remote calibration is prohibited</p> <p>D11: The calibration is in hardware protection</p> <p>D10: The previous weight point is not calibrated</p> <p>D09: Beyond the minimum resolution (less than 0.1uV per subdivision)</p> <p>D08: Weight input exceeds the maximum range</p> <p>D07: The weight input cannot be zero</p> <p>D06: Weight calibration less than zero or the previous standard point</p> <p>D05: Load cell overflow is positive during weight calibration</p> <p>D04: Negative load cell overflow during weight calibration</p> <p>D03: The weight calibration is not stable</p> <p>D02: Load cell overflow is positive during zero calibration</p> <p>D01: Negative load cell overflow during zero calibration</p> <p>D00: The zero calibration is not stable</p>
4	Error code 2	Word	<p>D14-D15 Reserved</p> <p>D13: The remote tare operation permit switch is not enabled when the tare is operated remotely</p> <p>D12: Net weight status does not allow tare</p> <p>D11: When tare, the weight is negative</p> <p>D10: Load cells overflow when tare</p> <p>D09: Negative load cell overflow during tare</p> <p>D08: Unstable when tare</p> <p>D07: The net weight status is not allowed to be cleared</p> <p>D06: The remote reset switch is not turned on during remote reset</p>

			D05: The load cell is overflowing when zero is cleared
			D04: Negative load cell overflow during zero clearance
			D03: Zero clearance is unstable
			D02: Clear out of range
			D01: Unstable when reset on power
			D00: Power on clear zero out of range
5	Process status flag	Word	D13-D15 Reserved
			D11: Current calibration under way
			D10: Voltage calibration under way
			D9: IO Testing state
			D8: In printing, (valid when the meter is performing printing operation)
			D7: The comparator 8 reaches, (the comparison condition is valid if the comparator 8 reaches)
			D6: The comparator 7 reaches, (the comparison condition is valid if the comparator 7 reaches)
			D5: The comparator 6 reaches, (the comparison condition is valid if the comparator 6 reaches)
			D4: The comparator 5 reaches, (the comparison condition is valid if the comparator 5 reaches)
			D3: The comparator 4 reaches, (the comparison condition is valid if the comparator 4 reaches)
			D2: The comparator 3 reaches, (the comparison condition is valid if the comparator 3 reaches)
			D1: The comparator 2 reaches, (the comparison condition is valid if the comparator 2 reaches)
D0: The comparator 1 reaches, (the comparison condition is valid if the comparator 1 reaches)			
6	Gross	DInt	Gross value (Signed integers)
8	Net weight	DInt	Net weight value (Signed integers)
10	Tare	DInt	Tare value (Signed integers)
12	Flow	DInt	Flow value (Signed integers)
14	Current weight	Float	Current display weight, floating-point type
16	Gross	Float	Gross value, floating-point type
18	Net weight	Float	Net weight value, floating-point type
20	Tare	Float	Tare value, floating-point type
22	Flow	Float	Flow value, floating-point type
24	AD code after filtering	DWord	AD code after filtering
26	Sensor voltage data	DWord	Signed numbers, integers, four decimal points
28	Relative zero voltage value	DWord	Signed numbers, integers, four decimal points
30	Input state area	Word	D5-D15 Reserved
			D4: Enter 5 state (Expand input 2)
			D3: Enter 4 state (Expand input 1)
			D2: Enter 3 state
			D1: Enter 2 state
			D0: Enter 1 state
31	Output state area	Word	D9-D15 Reserved
			D8: Output 9 state (Expand input 4)
			D7: Output 8 state (Expand input 3)
			D6: Output 7 state (Expand input 2)

			D5: Output 6 state (Expand input 1)	
			D4: Output 5 state	
			D3: Output 4 state	
			D2: Output 3 state	
			D1: Output 2 state	
			D0: Output 1 state	
32	Heartbeat communication	DWord	The Communication indicator light defines which network. The communication light blinks at a frequency of 1 Hz, and the communication heartbeat switches between 0 and 1 at a frequency of 1 Hz.	
34	Automatic zero	DWord	Current sensor voltage	
36	Gain point 1	DWord	Relative voltage value 1 (loadcell input - zero voltage)	
38	Gain point 2	DWord	Relative voltage value 2 (loadcell input - 1 voltage at reference point)	
40	Gain point 3	DWord	Relative voltage value 3 (loadcell input -2 voltage at reference point)	
42	Gain point 4	DWord	Relative voltage value 4 (loadcell input - 3 voltage at reference point)	
44	Gain point 5	DWord	Relative voltage value 5 (loadcell input - 4 voltage at reference point)	
46	Readout value	DWord	The value obtained by writing the address to be read	
48	Write status	Word	Write data return status 0: no error 1: register address illegal 2: parameter error	
49	Read status	Word	Read data return status 0: no error 1: register address illegal 2: parameter error	
0	Automatic zero	DWord	Current sensor voltage (write 1 to the communication address to perform automatic acquisition of zero calibration)	The address is written to the value to complete the calibration
2	Gain point 1	DWord	Input gain weight value 1	
4	Gain point 2	DWord	Input gain weight value 2	
6	Gain point 3	DWord	Input gain weight value 3	
8	Gain point 4	DWord	Input gain weight value 4	
10	Gain point 5	DWord	Input gain weight value 5	
12	Function state	DWord	D7-D31 Reserved	
			D6: P_EMPTY_LINE	
			D5: Print	
			D4: Cal zero	
			D3: Gross/Net weight	
			D2: Clear Tare	
			D1: Tare	
			D0: Zero	
14	The request to write value of the modbus address	DWord	Write value address. (Note: that a change in address does not write)This PARA modify connect port module support MODBUS address range from 100 to 660	
16	Input value	DWord	Input value to the request to write value of the modbus address (Note: only when value change will write in transmitter)	
18	The read request of the modbus address	DWord	Read address (Note: Can't read DWord address, when write an odd address) This PARA modify connect port module support MODBUS address ranging from 0 to 660	

10.8.1.2 Simple IO module address

Offsets	Parameter	Data type	Description
0	Display weight	DINT	The current weight of the display, integral type, When positive or negative overflows, 9999999 and -9999999 are displayed.
2	Weight status signal bit	Word	<p>D13-D15 Reserved</p> <p>D12: bipolar, (When bipolar is selected, the flag bit is valid)</p> <p>D11: Calculate the weight using the theoretical value (prompt the user when calculating the weight using the theoretical value)</p> <p>D10: ADC failure (ADC initialization failure or sampling interruption longer than expected)</p> <p>D9: Net weight of the current display, (distinguish which weight is currently displayed)</p> <p>D8: Million volt stability, (mark of million volt stability in calibration)</p> <p>D7: Negative load cell overflow, lower than the allowable range of load cell voltage</p> <p>D6: The load cell is overflowing, beyond the allowable range of load cell voltage</p> <p>D5: Weight negative overflow, weight less than "-(maximum range + 9D)"</p> <p>D4: The weight is positive overflow, the weight is greater than "maximum range + 9D"</p> <p>D3: Overflow state, (weight or load cell abnormality)</p> <p>D2: Display weight minus sign, (display weight is a negative number)</p> <p>D0: Stable</p>
3	Error code 2	Word	<p>D14-D15 Reserved</p> <p>D13: The remote tare operation permit switch is not enabled when the tare is operated remotely</p> <p>D12: Remote calibration is performed when remote calibration is prohibited</p> <p>D11: The calibration is in hardware protection</p> <p>D10: The previous weight point is not calibrated</p> <p>D09: Beyond the minimum resolution (less than 0.1uV per subdivision)</p> <p>D08: Weight input exceeds the maximum range</p> <p>D07: The weight input cannot be zero</p> <p>D06: Weight calibration less than zero or the previous standard point</p> <p>D05: Load cell overflow is positive during weight calibration</p> <p>D04: Negative load cell overflow during weight calibration</p> <p>D03: The weight calibration is not stable</p> <p>D02: Load cell overflow is positive during zero calibration</p> <p>D01: Negative load cell overflow during zero calibration</p> <p>D00: The zero calibration is not stable</p>
4	Sensor voltage data	DWord	Signed numbers, integers, four decimal points

6	Readout value	DWord	The master station requests the data returned by the meter, the value obtained according to the "request read address".
8	Write status	Word	Write data return status 0: no error 1: register address illegal 2: parameter error
9	Heartbeat communication	Word	After the connection is established, the value of the communication heartbeat of the PN will also be converted between 0 and 1 at the frequency of 1 Hz
0	Function state	DWord	D7-D31 Reserved D6: P_EMPTY_LINE D5: Print D4: Cal zero D3: Gross/Net weight D2: Clear Tare D1: Tare D0: Zero
2	The request to write value of the modbus address	DWord	Write value address. (Note: that a change in address does not write)This PARA modify connect port module support MODBUS address range from 100 to 660
4	Input value	DWord	Input value to the request to write value of the modbus address (Note: only when value change will write in transmitter)
6	The read request of the modbus address	DWord	Read address (Note: Can't read DWord address, when write an odd address) This PARA modify connect port module support MODBUS address ranging from 0 to 660

EIP acyclic parameter list

Parameter	Default Value	Description
TrZero Range	1	0-99d
STAB Range	1	0-99d
ZERO Range	20%	1% - 99%
Digit-Filter	4	0-9
ADV Filter	0	0-99
Unit	kg	g,kg,t,lb
Decimal Point	0	Range: 0; 0 0; 0 00; 0 000; 0 0000
Division	d=1	d = 1;Range: 1,2,5,10,20,50,100,200,500
Full Scale	10000	Instrument maximum value, generally take the sensor range Range: 0~999999; Set the prompt message when the over-range (" data over range "), so as not to overweigh the sensor damage

10.8.2 Device description file EDS

The device description file and connection method of GMT-X1 can be downloaded from the website of Shenzhen General Measure Technology Co., Ltd. (www.gmweighing.com)..

10.9 CAN OPEN Protocol

- 1) Support **100K, 125K, 250K, 500K, 1000K** bus speed, can set in the "CAN OPEN" parameter of communication parameters.
- 2) There are two different frame formats, mainly the length of the identifier field is different, with 11 bit identifier (ID) is the standard frame, and with 29 bit identifier is the extended frame. The frame format is detailed in the following table:

10.9.1 Standard frame active report data format

11bits frame ID	Bit4-bit10	address	Local device address(1~127)
	bit3	Frame function	10: active report weight; 11 active report voltage
	bit2		
	bit1	Reserved (fix 0)	
bit0			
Data format			
First data	Byte0	Reserved	fix 0
Second data	Byte1		
Third data	Byte2		
Fourth data data	Byte3	Channel state	Below state valid is 1 bit7: ADC error bit6: Fixd 0 bit5: load cell OFL bit4: weight OFL bit3: theory valid bit2: display NW bit1: stable bit0: zero
Fifth to eighth data	Byte4	Weight data	32-bit integer with a signed number, with the highest digit in the data. When positive or negative overflow occurs, the weight data is displayed as 9999999 or -9999999
	Byte5		
	Byte6		
	Byte7		

10.9.2 Standard frame read data format

11bits frame ID	Bit4-bit10	address	Target device address
	bit3	Frame Function	Fix 01: read parameter
	bit2		
	bit1	Frame di- rection	Fix 0: from host to slave machine
bit0	Data type	0: word(2byte); 1: Dword(4byte)	
Data format			
Word 0	Byte0	read address	
	Byte1		
Word 1	Byte2	0	
	Byte3		
Word 2	Byte4	0	
	Byte5		
Word 3	Byte6	0	
	Byte7		

Read back to result data format

11bits frame ID	Bit4-bit10	address	Local device address(1~127)
	bit3	Frame Function	Fix 01: read parameter
	bit2		
	bit1	Frame di- rection	Fix 0: from host to slave machine
bit0	Data type	0: word(2byte); 1: Dword(4byte)	
Back to data format			
Word 0	Byte0	Back to data	read address
	Byte1		
Word 1	Byte2		Operation result: 0 OK, 1 address error, 2 data unconscionable
	Byte3		

Word 2	Byte4		Read Dword Hi word AB part
	Byte5		
Word 3	Byte6		Read Dword Lo word CD part or read word
	Byte7		

10.9.3 Standard frame write in data format

11bits frame ID	Bit4-bit10	address	Target device address
	bit3	Frame	Fix 01: read parameter
	bit2	Function	
	bit1	Frame di- rection	Fix 0: from host to slave machine
	bit0	Data type	0: word(2byte); 1: Dword(4byte)
Data			
Word 0	Byte7	write in param- eter con- tent	write in address
	Byte6		0
Word 1	Byte5		write in Dword Hi word AB
	Byte4		
Word 2	Byte3		write in Dword Lo-word CD or word content
	Byte2		
Word 3	Byte1		
	Byte0		

Write in back to result data format

11bits frame ID	Bit4-bit10	address	local device address (1~127)
	bit3	Frame	Fix 00: parameter write in
	bit2	Function	
	bit1	Frame direction	Fix 1: From slave machine to Host
	bit0	Data type	0: word (2byte); 1: Dword(4byte)
Back to data format			
Word 0	Byte7	Back to data	write in address
	Byte6		Operation result: 0 OK, 1 address error, 2 data unconscionable
Word 1	Byte5		write in Dword Hi word AB
	Byte4		
Word 2	Byte3		write in Dword Lo-word CD or word content
	Byte2		
Word 3	Byte1		
	Byte0		

10.10 DP communication

The GMT-X1 monitor can be equipped with an optional PROFIBUS-DP bus connection port, which can be used as a standard PROFIBUS-DP slave station to connect to the master station on the bus. Provide 8AO+10AI, and the main station can read and control the status of the weighing display through these I/O.

10.10.1 Bus settings

When selecting Profibus DP communication during ordering, enter the 6xxx Bus Cfg menu and set the following parameters.

61x DP Param- eter	Initial value	Description
611x Slave ID	01	Range: 01-99
612x Write SW	Disable	Range: Disable/Enable;

		<p>Enable: Every time the instrument establishes communication with the master station, the parameters set in the "Device Specific Parameters" of the slave station equipment configuration are automatically written to the instrument.</p> <p>Disable : Every time the instrument establishes communication with the master station, it does not process the parameters set in the "device specific parameters" of the slave station equipment configuration.</p>
--	--	---

10.10.2 Simplified version of loop parameter address

Output from the instrument to the main station (10AI) (write register, Q address)			
Offset	Parameter Name	Data Type	Parameter Description
0	Current displayed weight	DWord	The current weight of the display, integral type, When positive or negative overflows, 9999999 and -9999999 are displayed.
4	Weight status indicator	Word	<p>D13-D15 Reserved</p> <p>D12: bipolar,(When bipolar is selected, the flag bit is valid)</p> <p>D11: Calculate the weight using the theoretical value (prompt the user when calculating the weight using the theoretical value)</p> <p>D10: ADC failure (ADC initialization failure or sampling interruption longer than expected)</p> <p>D9: Net weight of the current display, (distinguish which weight is currently displayed)</p> <p>D8: Million volt stability, (mark of million volt stability in calibration)</p> <p>D7: Negative load cell overflow, lower than the allowable range of load cell voltage</p> <p>D6: The load cell is overflowing, beyond the allowable range of load cell voltage</p> <p>D5: Weight negative overflow, weight less than "-(maximum range + 9D)"</p> <p>D4: The weight is positive overflow, the weight is greater than "maximum range + 9D"</p> <p>D3: Overflow state, (weight or load cell abnormality)</p> <p>D2: Display weight minus sign, (display weight is a negative number)</p> <p>D1: Zero, (weight in the range of 0+/- 1/4 D)</p> <p>D0: Stable</p>
6	Error code 2	Word	<p>D14-D15 Reserved</p> <p>D13: The remote tare operation permit switch is not enabled when the tare is operated remotely</p> <p>D12: Net weight status does not allow tare</p> <p>D11: When tare, the weight is negative</p> <p>D10: When tare, the weight is negative</p> <p>D09: Load cells overflow when tare</p> <p>D08: Unstable when tare</p> <p>D07: The net weight status is not allowed to be cleared</p> <p>D06: The remote reset switch is not turned on during remote reset</p> <p>D05: The load cell is overflowing when zero is cleared</p> <p>D04: Negative overflow of loadcell during zeroing</p> <p>D03: Zero clearance is unstable</p> <p>D02: Zeroing out of range</p> <p>D01: Unstable when reset on power</p>

			D00: Power on clear zero out of range
8	Sensor voltage data	DWord	Signed numbers, integers, four decimal points
12	Read out value	DWord	The master station requests the data returned by the meter, the value obtained according to the "request read address".
16	Write status	Word	Write data return status 0: no error 1: register address illegal 2: parameter error
18	Heartbeat communication	Word	After the connection is established, the value of the communication heartbeat of the PN will also be converted between 0 and 1 at the frequency of 1 Hz.
Output from the main station to the instrument (8AO)			
0	Function Operate	DWord	D7-D31 Reserve D6: P_EMPTY_LINE D5: Print D4: CAL ZERO D3: GROSS/NET D2: Clear Tare D1: TARE D0: ZERO
4	The request to write value of the modbus address	DWord	Write value address. (Note: that a change in address does not write)This parameter modify connect port module support MODBUS address range from 100 to 660
8	Input value	DWord	Input value to the request to write value of the modbus address (Note: only when value change will write in transmitter)
12	The read request of the modbus address	DWord	Read address (Note: Can't read DWord address, when write an odd address) This parameter modify connect port module support MODBUS address ranging from 0 to 660

10.10.3 Non cyclic parameter

Refer to [section 10.8.1.2 of EIP acyclic parameter list](#) in the simplified version. Add an automatic reset parameter for power on, ranging from 0 to 101 (* full-scale%).

10.10.4 Device description file GSD

The device description file and connection method of GMT-X1 can be downloaded from the website of Shenzhen General Measure Technology Co., Ltd. (www.gmweighing.com).

10.11 CCLINK IE Communication

When selecting CCLink IE Field Basic for extended communication, it can communicate with the PLC. The IP of the instrument and the PC and PLC must be in the same LAN. The instrument IP address can be set and viewed in the network port parameter 444x; Check the MAC address in item 571x of the system maintenance parameters. After establishing a successful engineering connection, parameters can be configured according to the following parameter addresses.

This instrument occupies one link station, and each link point can reach a maximum of 4K words. It can be applied to small-scale devices without the need for high-speed control. CC Link IE loop communication is implemented by software, and the communication speed also reaches 100Mbps.

10.11.1 Cycle parameter address

Offsets	Parameter	Data type	Specification
Weight and state parameters (read register, I address)			

RWr0-RWr1	Display Current Weight	DWord	Currently displayed weight. When positive or negative overflows, 9999999 and -9999999 are displayed. Select whether to display floating point numbers or integers from the 577x weight display type in the system parameters.
RWr2- RWr3	Weight state marker bit	DWord	<p>D31: communication heartbeat (After the connection is established, the value of the PN's communication heartbeat is converted between 0 and 1 at a frequency of 1 Hz)</p> <p>D13~D30: Reserve</p> <p>D12: bipolar,(When bipolar is selected, the flag bit is valid)</p> <p>D11: Use theory value calculate weight,(Use theory value calculate weight prompt user)</p> <p>D10: ADC failure (ADC initialization failure or sampling interruption longer than expected)</p> <p>D9: Net weight of the current display, ((Distinguish the stable millivolt value of the currently displayed weight, which is a marker for judging the stability of millivolt values during calibration))</p> <p>D8: Million volt stability, (mark of million volt stability in calibration)</p> <p>D7: Negative load cell overflow, lower than the allowable range of load cell voltage</p> <p>D6: The load cell is overflowing, beyond the allowable range of load cell voltage</p> <p>D5: Weight negative overflow, weight less than "-(maximum range + 9D)"</p> <p>D4: The weight is positive overflow, the weight is greater than "maximum range + 9D"</p> <p>D3: Overflow state, (weight or load cell abnormality)</p> <p>D2: Display weight minus sign, (display weight is a negative number)</p> <p>D1: Zero, (weight in the range of 0+/- 1/4 D)</p> <p>D0: Stable</p>
RWr4-RWr5	Error code 2	DWord	<p>D31: Write status (write data return status 0: no error 1: illegal register address/write parameter error)</p> <p>D14-D30 Reserve</p> <p>D13: The remote tare operation permit switch is not enabled when the tare is operated remotely</p> <p>D12: Net weight status does not allow tare</p> <p>D11: When tare, the weight is negative</p> <p>D10: Load cells overflow when tare</p> <p>D9: Negative load cell overflow during tare</p> <p>D8: Unstable when tare</p> <p>D7: The net weight status is not allowed to be cleared</p> <p>D6: The remote reset switch is not turned on during remote reset</p> <p>D5: The load cell is overflowing when zero is cleared</p> <p>D4: Negative load cell overflow during zero clearance</p> <p>D3: Zero clearance is unstable</p> <p>D2: Clear out of range</p> <p>D1: Unstable when reset on power</p>

			D0: Power on clear zero out of range
RWr6-RWr7	Sensor voltage data	DWord	Signed numbers, integers, four decimal points
RWr8-RWr9	Read out value	DWord	The master station requests the data returned by the meter, the value obtained according to the "request read address".
Functional operation parameters (write register, Q address)			
RY0	Function operation	DWord	D0: Zero
RY1			D1: Tare
RY2			D2: Clear Tare
RY3			D3: Gross/Net weight
RY4			D4: Cal zero
RY5			D5: Print
RY6			D6: P_EMPTY_LINE
RY7~ RY31			D7~D31: Reserved
RWw0-RWw1	The request to write value of the modbus address	DWord	Write value address. (Note: that a change in address does not write)This PARA modify connect port module support MODBUS address range from 100 to 660
RWw2-RWw3	Input value	DWord	Input value to the request to write value of the modbus address (Note: only when value change will write in transmitter)
RWw4-RWw5	The read request of the modbus address	DWord	Read address (Note: Can't read DWord address, when write an odd address) This PARA modify connect port module support MODBUS address ranging from 0 to 660

10.11.2 Non cyclic parameter

Refer to [section 10.8.1.2 of EIP acyclic parameter list](#) in the simplified version. Add an automatic reset parameter for power on, ranging from 0 to 101 (* full-scale%).

10.11.3 Device description file CSP

The device description file and connection method of GMT-X1 can be downloaded from the website of Shenzhen General Measure Technology Co., Ltd. (www.gmweighing.com).

10.12 EtherCAT communication

GMT-X1 has two bus connection ports: NET1 and NET2 with NET2 serving as the entry when EtherCAT is connected. ny computer with a network interface card and any embedded device with Ethernet control can serve as a master station for EtherCAT, such as devices such as Huichuan PLC. It is also possible to connect to the transmitter through Twin-cat software on a PC computer, in any case within the same LAN as the transmitter. The following parameter table can be used after the connection is successful.

10.12.1 Bus Cfg

When selecting EtherCAT communication during ordering, enter the 6xxx bus settings menu and set the following parameters.

62xEtherCAT	Initial value	Specification
621xAlias	01	Range: 0-65535
622xWrite SW	Disable	Range: Disable/Enable;Non cyclic parameters can only be written after activation.

10.12.2 EtherCAT cycle parameter list

GMT-X1 EtherCAT communication provides multi byte IO, divided into two modules for output. The main station can read and control the status of the weighing display through these I/O. Provide 14 byte input and 14 byte output.

Offset	Parameter	Data	Description
Weight, millivolts, and status parameters (read-only, I address)			
0	Current Weight	REAL	The current displayed weight shows 9999999 or -99999999 when positive or negative overflow occurs. Select whether to display floating-point or integer through menu 577x.
4	Weight status marker bit	DINT	D31: communication heartbeat (After the connection is established, the value of the PN's communication heartbeat is converted between 0 and 1 at a frequency of 1 Hz)
			D13-D30: Reserve
			D12: bipolar,(When bipolar is selected, the flag bit is valid)
			D11: Use theory value calculate weight,(Use theory value calculate weight prompt user)
			D10: ADC failure (ADC initialization failure or sampling interruption longer than expected)
			D9: Net weight of the current display, ((Distinguish the stable millivolt value of the currently displayed weight, which is a marker for judging the stability of millivolt values during calibration))
			D8: Million volt stability, (mark of million volt stability in calibration)
			D7: Negative load cell overflow, lower than the allowable range of load cell voltage
			D6: The load cell is overflowing, beyond the allowable range of load cell voltage
			D5: Weight negative overflow, weight less than "-(maximum range + 9D)"
			D4: The weight is positive overflow, the weight is greater than "maximum range + 9D"
			D3: Overflow state, (weight or load cell abnormality)
			D2: Display weight minus sign, (display weight is a negative number)
D1: Zero, (weight in the range of 0+/- 1/4 D)			
D0: Stable			
6	Millivolts of loadcell	REAL	Read absolute millivolts
10	Read out value	DINT	The master station requests the data returned by the meter, the value obtained according to the "request read address".
Function operation (write register, Q address)			
0	Function Operation	Byte0	D0: Zero
			D1: Tare
			D2: Clear Tare
			D3: Gross/Net weight
			D4: Cal zero
			D5: Print
			D6: P_EMPTY_LINE
			D7: Reserved
		Byte1	D0-D7 Reserved

2	The request to write value of the modbus address	DWord	Write value address. (Note: that a change in address does not write)This parameter modify connect port module support MODBUS address range from 100 to 660,refer to 10.1.3Modbus communication data sheet .
6	Input value	DWord	Input value to the request to write value of the modbus address (Note: only when value change will write in transmitter)
10	The read request of the modbus address	DWord	Read address (Note: Can't read DWord address,when write an odd address) This parameter modify connect port module support MODBUS address ranging from 0 to 660refer to 10.1.3Modbus communication data sheet .

10.12.3 Non cyclic parameter

Refer to [section 10.8.1.2 of EIP acyclic parameter list](#) in the simplified version. Add an automatic reset parameter for power on, ranging from 0 to 101 (* full-scale%).

10.12.4 Device description file ESI

The device description file for GMT-X1 and the specific steps for using PLC and Twincat can be downloaded from the website of Shenzhen General Measure Technology Co., Ltd. (www.gmweighing.com).

11. DIMENSION

