



杰 · 曼 · 科 · 技

GMC-X904_D

User Manual

110612100003

V02.00.02

©2023, Shenzhen General Measure Technology Co., LTD. All rights reserved.

Without the permission of Shenzhen General Measure Technology Co., LTD., no unit or individual may copy, transmit, transcribe or translate into other language versions in any form or by any means.

Due to the continuous improvement and update of our products, our company reserves the right to modify this manual at any time without prior notice. To this end, please visit the company's website frequently for timely information.

The company's Web address www.gmweighing.com

Implementation standard of this product: GB/T 7724-2008



Contents

1.	Overview	- 1 -
1.1	Functions and features.....	- 1 -
1.2	Panel Description	- 1 -
1.3	Technical Specifications	- 3 -
1.3.1	General Specifications.....	- 3 -
1.3.2	Analog part	- 3 -
2.	Install wiring	- 4 -
2.1	Power Connection	- 4 -
2.2	Connection of the sensor	- 4 -
2.3	Connection of the switching quantity interface.....	- 4 -
2.4	Serial port connection.....	- 5 -
2.4.1	Troubleshooting Serial Port Faults	- 6 -
2.5	Network Port Connection.....	- 6 -
2.5.1	Troubleshooting Network Port Faults	- 6 -
3.	Parameter Description	- 7 -
3.1	Calibration Scale Parameters (CAL).....	- 7 -
3.1.1	Zero point calibration	- 7 -
3.1.2	Gain calibration	- 8 -
3.2	Recipe Parameters (REC).....	- 8 -
3.3	Peripheral Parameters (Perip).....	- 12 -
3.3.1	Patting bag parameters (P1)	- 12 -
3.3.2	Coding parameters (P2).....	- 13 -
3.3.3	Conveyor Parameters (P3)	- 13 -
3.3.4	Parameters of the sewing machine (P4)	- 13 -
3.3.5	Discharging Vibration Parameters (P5).....	- 14 -
3.3.6	Auxiliary Pulse Parameters (P6)	- 15 -
3.4	Working Parameters (Setup).....	- 15 -
3.5	Motor Parameters (Motor).....	- 19 -
3.5.1	Charging Motor Parameters (U2).....	- 19 -
3.5.2	Bag locked/unlocked parameters (U3)	- 20 -
3.5.3	Discharge parameters (U4) Valid in bucket mode).....	- 21 -
3.6	Communication Parameters (COM).....	- 23 -
3.7	Resetting Parameters (Reset).....	- 24 -
3.8	System Parameters (Sys)	- 24 -
3.9	IO module (IO).....	- 25 -
3.9.1	Output/Input Port Definition (IO def)	- 26 -
3.9.2	IO test (IO test).....	- 36 -
4.	Function Description	- 38 -
4.1	Set work mode.....	- 38 -
4.2	Batches	- 38 -
4.3	Filling Level Control.....	- 39 -
4.3.1	Double level	- 39 -
4.3.2	Single feed level	- 39 -
4.4	Sewing control.....	- 39 -
4.5	Discharge patting control	- 40 -
4.6	Alarm function of filling and discharge overtime	- 40 -
4.7	Auxiliary pulse function	- 40 -
4.8	Adaptive function	- 41 -
4.9	Hanger up control function.....	- 41 -

4.10 Logic programming function.....	- 41 -
4.11 Character mapping table.....	- 45 -
4.12 Alarm information	- 45 -
5. Serial communication.....	- 46 -
5.1 Printing Method.....	- 46 -
5.1.1 Automatic printing	- 46 -
5.1.2 Total cumulative printing	- 47 -
5.1.3 Recipe cumulative printing	- 47 -
5.1.4 User Cumulative printing	- 47 -
5.2 Continuous Mode	- 48 -
5.2.1 Data frame format is as follows:	- 48 -
5.3 Modbus-RTU protocol	- 48 -
5.3.1 Function code and exception code	- 48 -
5.3.2 MODBUS Transmission Mode	- 49 -
5.3.3 MODBUS address assignment	- 49 -
6. Automate the packaging process.....	- 77 -
6.1 There are bucket AB double scale packaging methods	- 77 -
6.2 Separate A scale, B scale packaging method.....	- 79 -
6.3 Double bucket double bag AB independent packaging method.....	- 79 -
6.4 Double bucket double clip bag AB combination packing method	- 79 -
6.5 No bucket double scale combination packaging method	- 79 -
6.6 No bucket double scale independent packaging method.....	- 80 -
6.7 Packing method of bulk materials	- 80 -
7. Motor working process.....	- 82 -
7.1 Motor feeding part.....	- 82 -
7.1.1 Stepper motor feeding	- 82 -
7.1.2 General motor feeding.....	- 82 -
7.2 Motor clip bag part.....	- 83 -
7.2.1 Stepper motor clip loose bag	- 83 -
7.2.2 Motor double limit pinch pouch release	- 83 -
7.2.3 Motor single limit pinch pouch release	- 84 -
7.3 Motor discharge section	- 84 -
7.3.1 Stepping motor discharging	- 84 -
7.3.2 Single limit discharge of motor	- 85 -
7.3.3 Motor double limit discharge	- 85 -
7.3.4 Unidirectional rotation of the motor for one week unloading	- 86 -
8. Instrument size (mm)	- 87 -

1. Overview

GMC-X904D Packing controller is a new type of load control instrument specially developed for automatic quantitative packing scale with double scale increment method. The new algorithm makes the weighing control faster and more accurate; Dual serial ports make it easier for devices to interconnect. It can be widely used in feed, chemical, grain and other industries that need quantitative packaging equipment.

1.1 Functions and features

Shell Type	DIN Rail mounted(National standard 35mm card rail), stainless steel housing	
Display	Double row 6-bit display nixie tube	
Language	Chinese and English are supported	
Port	Loadcell interface	Support 2 6-wire analog load cell weighing platform interface, connect up to 8 350 Ω sensors per channel
	1 way 485 interface	Support modbus RTU , continuous mode, print mode, etc
	1 way 232 interface	
	Transistor I/O interface	12 in 16 out Transistor I/O interface, the position of the input and output ports can be customized
	Dual network ports/ Single network port	Supports TCP-IP protocol communication
Function Description	<ul style="list-style-type: none"> ➤ Support a variety of scale body mode switching, there is a bucket, no bucket, bulk mode. Users can choose independently ➤ Rich switching interface, with testing function, convenient packaging scale debugging ➤ Automatic double speed, three speed feeding control, with point feeding function ➤ Can store 20 kinds of recipe, convenient packaging of different range materials ➤ Filling control function, convenient packaging scale and front-end feeding equipment control connection ➤ Feed speed adaptive function ➤ Automatic drop correction function ➤ Batch number setting function ➤ Support a variety of peripheral functions, such as bag patting, coding, sewing machine, conveyor, unloading vibration and so on ➤ Automatic zero tracking function ➤ Multiple digital filtering function ➤ Dual serial port for external serial printer, computer or second monitor ➤ With double network port communication function, easy to communicate with the host computer ➤ Support filling, discharging and locking/unlocking bag motor mode control function 	

1.2 Panel Description

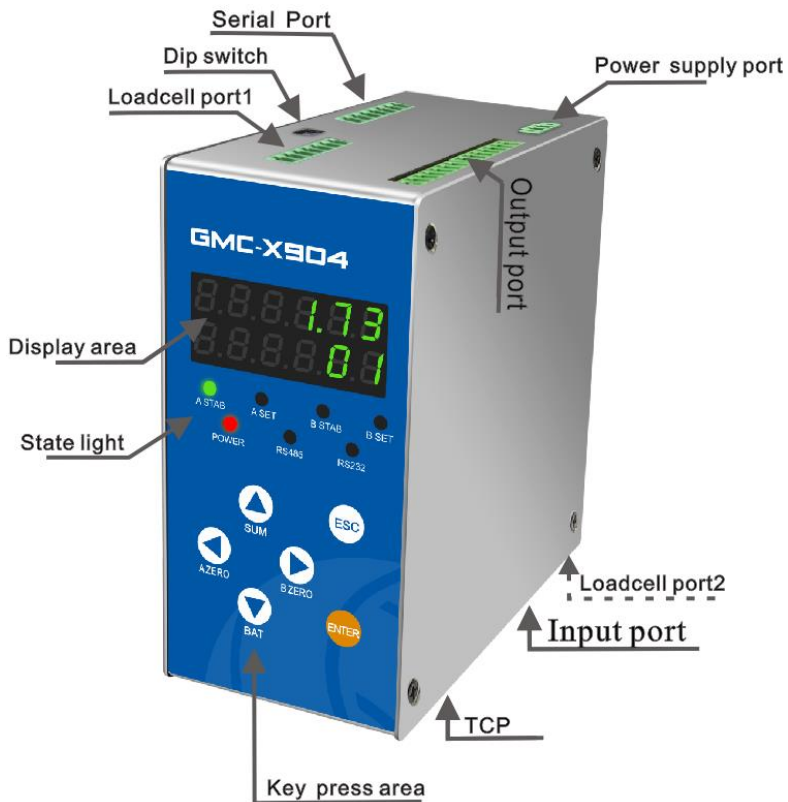

Status indicator Instructions:

- A STAB:** when the weight of A scale is stable, the indicator lights up;
- A SET:** when the parameters of A scale are set, the indicator lights up;
- B STAB:** when the weight of B scale is stable, the indicator lights up;
- B SET:** when B scale is set, the indicator lights up;
- POWER:** when the instrument is powered on, the indicator is steady on;
- RS485:** During the RS485 communication, the indicator blinks.
- RS232:** The indicator blinks during RS232 communication.





Dip switch instructions:

Dip switch: communication mode switch, when the dip switch to the user direction (near the serial port), the instrument according to the user set protocol and format for data communication. To the Default end (near the sensor end), the instrument is fixed by pressing 38400, 8-N-1, MODBUS-RTU for data communication.



Button description:

Keys	Function description
	Scroll up/Toggle options/Current input value +1 Short press this key on the home screen to view the number of batches and total accumulated weight

	Press and hold on the home screen to clear the cumulative
	Scroll down/Toggle options/Current Input value -1
	Hold down this key for 2 seconds on the home screen to set the number of batches
	Short press this key on the home screen to view the number of batches and the number of remaining batches
	The left Page Turn/Left scroll key is used to switch between menu items
	Clear key, used to clear the weight of A scale that meets the clear range and is stable
	The right flip/right scroll key is used to switch between menu items
	The reset key is used to reset the weight of B scale that meets the reset range and is stable
	Exit key, used to exit the current operation of the instrument/return to the previous level menu key.
	The Confirm key, which determines the input/confirm options
	Access menu

1.3 Technical Specifications

1.3.1 General Specifications

Power source: DC24V

Power filter: included

Working temperature: -10 ~ 40°C

Max humidity:90% R.H. No condensation

Power consumption: about 15W

Physical dimensions:61*132*126mm

1.3.2 Analog part

Sensor power supply: DC 5V 125mA(MAX)

Input resistance: 10MΩ

Zero adjustment range: 0.002 ~ 15mV (when the sensor is 3mV/V)

Input sensitivity: 0.1uV/d

Input range:0.02~15mV

Conversion method: Sigma-Delta

A/D conversion speed:120,240,480,960 times/second

Non-linear: 0.01% F.S

Gain drift: 10PPM/ °C

Maximum display accuracy: 1/100000

2. Install wiring

2.1 Power Connection

The **GMC-X904D** package controller uses **24V** DC power supply. The connection is shown below:

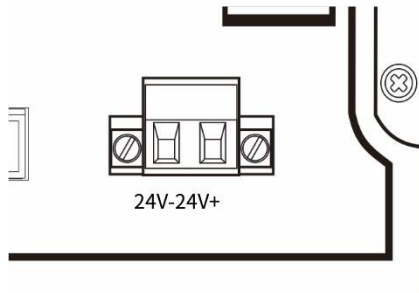

Power terminal diagram:

24V+ connects to DC positive, 24V- connects to DC negative.

Note: This product uses DC 24V power supply, using AC 220V power supply will permanently damage the instrument, and danger!!

2.2 Connection of the sensor

The **GMC-X904D** packaging controller can be connected to two resistance strain bridge sensors. When a four-wire sensor is selected, the SN+ of the sensor must be short-circuited with the EX+, and the SN- must be short-circuited with the EX-.

port	EX+	SN+	EX-	SN-	SIG+	SIG-	SHL
Six-wire	Power positive	Sensing positive	Power negative	Sensing negative	Signal positive	Signal negative	Shielded wire
Four-wire	Power positive		Power negative		Signal positive	Signal negative	Shielded wire

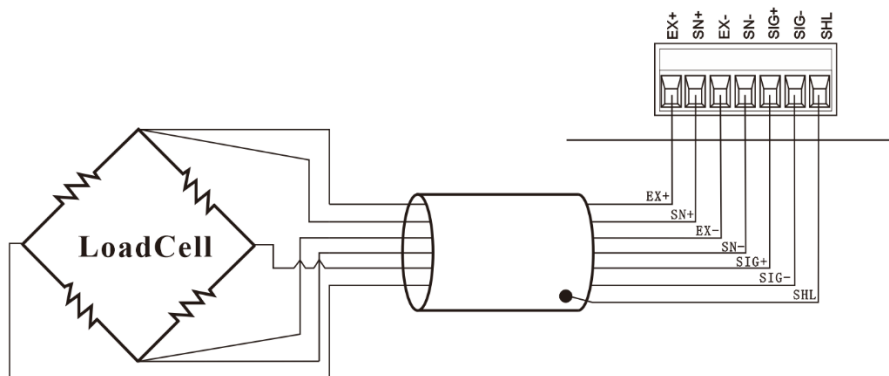

2.3 Connection of the switching quantity interface

The **GMC-X904D** packing controller contains **28** switching input and output controls (**12** in / **16** out). Adopt photoelectric isolation mode, the instrument internal power drive. The IO input of the instrument is effective at low level; Output transistor collector open output mode, each drive current up to 200mA, full load current up to 3A. The terminal connection is shown in the following figure:

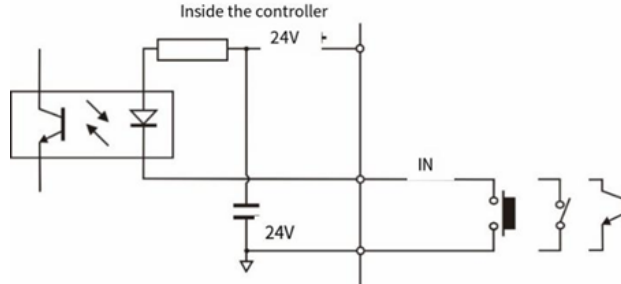
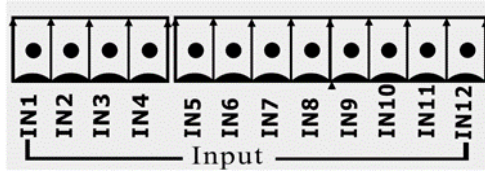

IO input interface diagram

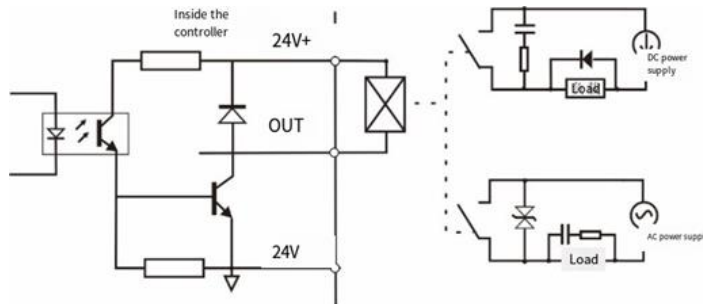
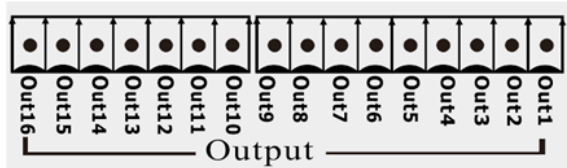

IO output interface diagram

GMC-X904D packing controller IO for the user can be customized, in order to facilitate the user wiring and some special applications, IO content refer to [Chapter 3.9](#).

2.4 Serial port connection

GMC-X904D can provide two serial communication interfaces, as shown in the following figure. RS-232 mode (terminal TX, RX, GND) and RS-485 (terminal A, B, GND). Serial port support: MODBUS protocol, continuous mode, print format and Re-ContA, Re-ContB etc.

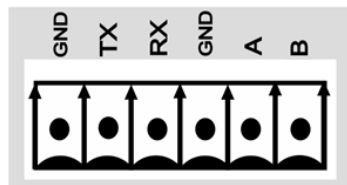

Instrument and computer connection diagram:

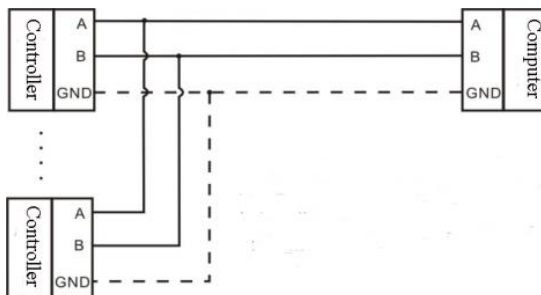

Instrument and computer connection diagram (RS-485 mode)

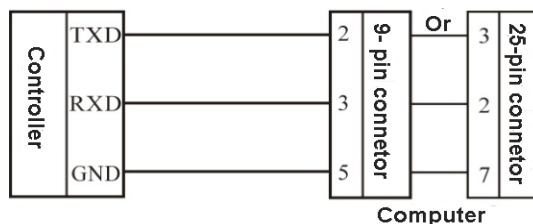

Instrument and Host computer connection diagram (RS-232 mode)

2.4.1 Troubleshooting Serial Port Faults

If the serial port is not communicating, check:

- Check the connection according to the serial port connection; Make sure the connection is correct.

The RS232 interface must be connected to all three wires, Rx, Tx, GND.

The RS485 interface must be connected to A and B wires.

- Ensure that the parameters of the connection port are consistent with those of the host.

Slave ID, baud rate, data format and communication protocol must be consistent with the host computer and PLC.

2.5 Network Port Connection

The product supports common network port communication and supports **Modbus** TCP network port protocol. Dual network port option, network port built-in switch, easy to cascade. The network port parameters must be set in Modbus address zone **1100 to 1105 (4x1101 to 4x1106)**. For details, [see the chapter 5.3.3 of MODBUS Address Assignment table.](#)

2.5.1 Troubleshooting Network Port Faults

If the network port is not communicating, check:

- Check network port indicators.

The hardware connection is normal, and the internal indicator of the instrument is steady on.

The network cable is connected properly, and the connection indicator is blinking.





- Check whether the communication protocol is consistent with that of the host computer and PLC.
- Check that the instrument can be pinged from the network. If not, check the hardware interface section.
- Check whether IP conflicts exist.
- Restart the instrument.

3. Parameter Description

3.1 Calibration Scale Parameters (CAL)







Set the weight parameters and calibrate the instrument. Calibration is instrument calibration, the first use of **GMC-X904D** packaging controller or any part of the weighing system has changed and the current equipment calibration parameters can not meet the user's requirements, should be calibrated controller, calibration parameters directly affect the instrument weighing results.

Calibration parameters MODBUS address range is **0050~0080 (4x0051~4x0081)**, [see the chapter 5.3.3 of MODBUS Address Assignment table.](#)

Symbols	Parameters	Instructions
Unit	Unit	Initial value: kg; g/kg/t/lb four options are available.
Point	Decimal point	Initial value: 0.00; 0 to 0.0000 five options available.
Div	Minimum division	Initial value: 1; 1/2/5/10/20/50 Six options available.
CAP	Maximum range	Initial value: 100.00 ; The range is less than or equal to the minimum index $\times 100000$ can be set
SE out	Millivolt output	Read out the millivolts of the sensor currently displayed
A Zero	A scale zero calibration	Empty the scale table, display the zero millivolt, press the button  to carry out zero calibration on the scale A .
A Load	Weight calibration	Load the weights, display the relative millivolts after loading, press the button  to complete and calibrate with the current relative millivolts gain.
B Zero	B scale zero calibration	Empty the scale table, display zero millivolts, press the button  for zero calibration of B scale.
B Load	Weight calibration	Similarly, load the weights on B scale, display the gain millivolts after loading the weights, press the button  to confirm, prompt "SUCC", you can complete the calibration process.





3.1.1 Zero point calibration

Calibrate the instrument, first carry out zero calibration, carry out zero calibration operation on A scale and B scale respectively.

	A scale zero calibration interface; Press  to enter the display of the current millivolt, and press  complete the zero calibration when the scale is stable.
	B Scale zero calibration interface; Press  to enter the display of the current millivolt, and press  complete the zero calibration when the scale is stable.

3.1.2 Gain calibration

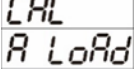
After the zero point calibration is completed, enter the gain calibration interface, load the weight to the scale, and input the weight value of the weight when the scale is stable. Press the button to complete the gain calibration.

	A scale gain calibration interface; Press  to enter the calibration interface, load weights on the scale platform of A , at this time, the first row is displayed as the gain millivolts, and enter the weight value of weights in the second row.
	B scale gain calibration interface; Press  to enter the calibration interface, load the weights on the B scale platform, at this time, the first row is displayed as the gain millivolts, and enter the weight value in the second row.

3.2 Recipe Parameters (REC)

It is used to set the parameters related to the packaging weight value, including quantitative parameters, quantitative time parameters, over and under parameters, drop correction parameters, adaptive parameters, slow point dynamic parameters and the setting parameters corresponding to different weighing modes.

No.	Parameters	Initial values	Instructions
F1.1	Recipe ID	1	Set the current recipe number. Range: 1 to 40 .
F2.1	Target values	0	Quantitative target value.
F2.2	A Scale target value	0	Set the target value of scale A separately
F2.3	B Scale target value	0	Set the target value of the scale B separately
F2.4	Zero zone values	0.00	In the process of quantification, if the weighing value is less than the zero zone value, then start the unloading delay timer. Range: 0~ maximum measuring range.
F2.5	Adaptive switch	0	Adaptive function, open the switch after the operation process automatically adjust the instrument fast, medium and slow lead and ban time. Optional range: 0 -off, 1 - double speed, 2 - three speed. (Note: 1. The drop correction and adaptive function cannot be turned on at the same time. If the adaptive function is turned on, the drop correction function must be turned off. 2. When the first scale is self-adaptive, it must ensure that the scale body is stable and the current weight is zero)
F2.6	Adaptive Level	3	The lower the grade, the faster the feeding speed and the relative reduction in accuracy. Range: 1 to 5 .
F2.7	Parameter update switch	OFF	When turned on, the change value of the fast, medium and slow lead is updated to the quantitative parameter value; When off, the quantitative parameter value cannot be updated. ON and OFF are optional
F3	Set the A scale quantitative parameters		

F3.1	A Scale Co-Fi remain	0.00	During the quantitative process, if the weighing value is \geq the target value - fast increase the lead amount, then turn off the fast increase. Range: 0~ maximum measuring range.
F3.2	A scale Me-Fi remain	0.00	In the quantification process, if the weighing value is \geq the target value - add the leading amount, then close the adding. Range: 0~ maximum measuring range.
F3.3	A scale Free Fall	0.00	In the quantification process, if the weighing value is \geq the target value - the drop value, the slow addition is turned off. Range: 0~ maximum measuring range.
F3.4	A scale COMP.Inhibit.Time(Co-F)	900	At the beginning of the ration, during this time, in order to avoid overshooting without weight judgment, fast add is always effective. Range: 0~9999 . (Unit: ms)
F3.5	A scale COMP.Inhibit.Time(Me-F)	900	After the end of the fast addition, during this time, in order to avoid overshooting without weight judgment, the addition has been effective. Range: 0~999 . (Unit: ms)
F3.6	A scale COMP.Inhibit.Time(Fi-F)	900	After the end of adding, during this time, in order to avoid overshooting without weight judgment, slow adding is always effective. Range: 0 to 9999 . (Unit :ms)
F4	Set the B scale quantitative parameters		
F4.1	B Scale Co-Fi remain	0.00	During the quantitative process, if the weighing value is \geq the target value - fast increase the lead amount, then turn off the fast increase. Range: 0~ maximum measuring range.
F4.2	B scale Me-Fi remain	0.00	In the quantification process, if the weighing value is \geq the target value - add the leading amount, then close the adding. Range: 0~ maximum measuring range.
F4.3	B scale Free Fall	0.00	In the quantitative process, if the weighing value is greater than the target value - the drop value, the slow loading is turned off. Range: 0~ maximum measuring range.
F4.4	B scale COMP.Inhibit.Time(Co-F)	900	At the beginning of the ration, during this time, in order to avoid overshooting without weight judgment, fast add is always effective. Range: 0~9999 . (Unit: ms)
F4.5	B scale COMP.Inhibit.Time(Me-F)	900	After the end of the fast addition, during this time, in order to avoid overshooting without weight judgment, the addition has been effective. Range: 0~999 . (Unit: ms)
F4.6	B scale COMP.Inhibit.Time(Fi-F)	900	After the end of adding, during this time, in order to avoid overshooting without weight judgment, slow adding is always effective. Range: 0 to 9999 . (Unit :ms)
F5	Set the quantitative time parameter values		
F5.1	Delay before feeding	0.5	In the metering bucket mode, at the beginning of the quantitative process, after this delay time, the instrument is judged stable and cleared (if it does not meet the conditions of the clearance interval, it is not

			judged stable and not cleared), and then the feeding process begins; In no metering bucket mode, after the bag is completed, after this delay time, the instrument is judged to remove the skin. Range: 0.0~99.9 . (Unit :s)
F5.2	Result waiting Time	1.0	When the setting mode is selected as "delay setting", after the slow feeding is closed (or the over-under-error is opened, the over-under-error alarm is finished), the setting is started. After this holding time, the setting is considered to be over, and the next process is entered. Range: 0.0~99.9 . (Unit :s)
F5.3	Discharging delay time	0.5	In the unloading process, when the weight value of the weigher is less than the zero zone value, start this delay, and turn off the unloading signal at the end of the delay. Range: 0.0~99.9 . (Unit :s)
F5.4	Discharge interlock time	0.5	In bucket combination mode, the unloading interval time value of A and B scales. Range: 0.0~99.9 . (Unit :s)
F5.5	Bracket up delay	0.0	In no bucket mode, execute this delay after the rise signal is issued. Range: 0.0 to 99.9 . (unit s).
F5.6	Bracket down delay	0.0	In no bucket mode, start the quantitative delay after it ends. Range: 0.0 to 99.9 . (Unit s)
F5.7	Delay after pinch loose bag	0.5	After giving the bag clamping signal, after this delay, the instrument judges that the bag clamping action is completed. Range: 0.0~99.9 . (Unit :s)
F5.8	Delay before bag unlock	0.5	After the discharge of bucket mode, the output loose bag signal through this delay time; No bucket mode setting (bag shot) after the completion, through this delay output loose bag signal. Range: 0.0~99.9 . (Unit :s)
F5.9	Effective blanking level delay	4.0	No bucket mode is effective, A scale bag after the detection of the material level effective start feeding, in the time B scale also bag, then even if the material level is invalid then B scale should start feeding. Range: 0.0~99.9 . (Unit :s)
F6	Used to set parameters related to overshoot and undershoot alarm reminders		
F6.1	Over and under detection ON/OFF	OFF	"ON/OFF" is optional. When this parameter is set to "ON", the quantitative process performs overshoot and undershoot judgment.
F6.2	Over/Under pause ON/OFF	OFF	"ON/OFF" is optional. When it is set to "ON", the meter will pause and wait for the user to handle when the quantitative process exceeds or underperforms. Switch quantity input emergency stop, return to the stop state, and clear the alarm; Or switch quantity input clear alarm, alarm clear continue the quantitative process.

F6.3	Over and under alarm time	1.0	When the alarm is not manually cleared, after the alarm time is set, the alarm of overshoot and undershoot will close by itself. Range: 0.0 ~ 99.9 . (Unit s)
F6.4	Over value	0.00	In the quantitative process, if the weighing value is \geq the target value + the excess value, it is judged as the excess value. Initial value: 0 .
F6.5	Under value	0.00	In the quantitative process, if the weighing value is less than the target value - underdifference value, it is judged as underdifference. Initial value: 0 .
F6.6	Supplement material ON/OFF	OFF	Set the undergap feed judge switch. ON: When the underdifference is insufficient, the feed is output slowly according to the feed times, and the parameters of F3.7~F3.9 can be seen. OFF: no feeding when underdifference occurs.
F6.7	Supplement material times	1	When the quantitative process is judged to be underweight, slow feeding is carried out according to this value. Range 1 to 99 .
F6.8	Effective supplement time	0.5	When feeding output, within a on-off cycle, slowly increase the effective time. Range: 0.0 ~ 99.9 (unit s).
F6.9	Ineffective supplement time	0.5	When feeding output, within a on-off cycle, slowly increase the effective time. Range: 0.0 ~ 99.9 (unit s).
F7	Used to set parameters related to free fall		
F7.1	Free fall correction ON/OFF	OFF	The drop value is the weight value that does not fall into the measuring bucket after turning off the slow adding signal. The drop correction is according to the actual blanking value as required. "ON/OFF" is optional. When this parameter is set to "ON", the quantification process carries out the drop correction. (Note: drop correction and adaptive function cannot be turned on at the same time. If you want to turn on the drop correction, ensure that the adaptive function is not turned on.)
F7.2	Correction sampling times	1	The meter will be set the number of times of the drop value of the average of the average, as the basis for the correction of the drop. Range: 1 ~ 99 .
F6.3	Free fall correction range	2.0	When the value of this drop exceeds the set range, this drop will not be counted in the arithmetic average range. Range: 0.0 to 9.9 . (Percentage of target value)
F7.4	Free fall correction magnitude	50%	The magnitude of each drop correction; Three ranges of 100%, 50%, 25% are optional.
F8	Used to set related parameters such as quick mode		
F8.1	Quick feed mode ON/OFF	OFF	"ON/OFF" is optional, and if you set it to "ON", the meter turns on the fast mode function.
F8.2	Fast mode time	50	Fast mode cutoff time. Range: 0 to 999 . (in ms)
F8.3	Fast Mode Weight A	0.00	Fast Mode cutoff weight value. Range: 0~ maximum range
F8.4	Number of quick mode correct	5	Use quick mode to automatically correct times. Range: 0 to 9

F8.5	Fast Mode Stabilization time	100	Steady scale time of the meter after the fast mode function is turned on. Range: 0 to 999 . (in ms)
F8.6	Fast Mode Weight B	0.00	Fast Mode cutoff weight value. Range: 0 ~ maximum range

3.3 Peripheral Parameters (Perip)

The instrument is equipped with peripheral control functions such as patting bag, sewing bag, unloading vibration, conveyor, coding, etc. The MODBUS address range of peripheral parameters is **0250~0297 (4x0251~4x0298)**, [see the chapter 5.3.3 the MODBUS address assignment table.](#)

3.3.1 Patting bag parameters (P1)

No.	Parameters	Initial values	Instructions
P1	Set the patter bag parameters.		
P1.1	Patting Bag Mode	PoFF	Bag mode selection: PoFF (no bag)/ P-d (bag after setting value)/ PF- (bag in feeding)/ PFd (bag after setting value in feeding); Note: With bucket mode only ① PoFF (no shooting bag) / P-d (shooting bag after setting value) optional; ② PLC mode is not optional.
P1.2	Pat bag starting weight	0	No bucket, ton bag, valve scale mode is effective, select the feeding in the bag mode, when the feeding in the bag, the current weight must be greater than or equal to the starting weight of the bag, to start the bag. Range: 0 ~ maximum measuring range.
P1.3	Pat times in filling	0	Set the parameter of the number of patting bags in the feed, set to 0 , no patting bags. Note: When the feed process enters the slow feed, force the end of the feed in the bag, regardless of whether the feed in the bag is completed. (Do not fill the middle slap bag after entering the small cast) The number of times that the initial weight of the slap bag corresponds to the slap bag. Range: 0 to 99 .
P1.4	Pat times after valuing	4	Set the parameter, the number of bag shots after setting the value. (Note: the patting bag mode is the patting bag after the fixed value, and the parameters of the patting bag after the fixed value in the feeding are visible) range: 0~99 .
P1.5	Pat bag before delay	0.5	After the racket bag is started, the racket bag output is effective after this delay time. Range: 0.0~99.9 . (Unit s)
P1.6	Pat bag effective time	0.5	Beat bag within a on-off cycle, beat bag output effective time. Range: 0.0~99.9 . (Unit s)
P1.7	Pat bag ineffective time	0.5	Beat bag within a on-off cycle, beat bag output invalid time. Range: 0.0~99.9 . (Unit s)
P1.8	Extra pat bag effective time	0.0	Generally used in pier bag function. (Note: The patting bag mode is the patting bag after the fixed value, and the parameters of the patting bag after the fixed value in the feeding are visible)

			<p>After the end of all the bags, add an additional bag output, the effective time is the set time of the value, and the invalid time is the "bag invalid time".</p> <p>Range: 0.0 to 99.9. (Unit s)</p> <p>(Note: The time of release bag delay startup remains unchanged, or start the "delay before release bag" time after the effective end of all the original slap bag output, that is, start the additional slap bag output effective time after the end of the effective time. In order to achieve the pier bag function, the time and the "loosening bag delay" time should be appropriately set, but the time setting should generally be greater than the "loosening bag delay", that is, the bag is loosened first after the bag pier goes down, and then the pier bag mechanism rises again).</p>
--	--	--	--

3.3.2 Coding parameters (P2)

No.	Parameters	Initial values	Instructions
P2	Used to set parameters related to coding.		
P2.1	Code ON/OFF	OFF	ON/OFF Optional, set to "ON", the instrument has the function of coding output.
P2.2	Code start delay	0.5	Bag is completed, the output is valid after this delay coding. Range: 0.0~99.9 . (Unit s)
P2.3	Code effective time	0.5	Code effective time. Range: 0.0 to 99.9 . (Unit s)
P2.4	Feed/discharge switches are not allowed when coding	OFF	ON/OFF optional; Set to "ON" to enable the feed (no bucket mode) output or discharge (with bucket mode) output during coding.

3.3.3 Conveyor Parameters (P3)

No.	Parameters	Initial values	Instructions
P3	Used to set parameters related to conveyor configuration.		
P3.1	Conveyor mode	OFF	Optional: OFF, ON , set to ON to turn on the conveyor output function.
P3.2	Conveyor starting delay	0.5	After this delay after loosening the bag, the instrument judges that the conveyor is started. Range: 0~99.9 . (Unit s)
P3.3	Conveyor running time	4.0	Conveyor run time Settings. Range: 0~99.9 . (Unit s)
P3.4	B scale delay start feed time	2.0	No bucket combination mode, B scale again feed delay. This function is only effective for B scale , to prevent the problem that the bag under the bag will hold the charging bag after the bag is added immediately. Range: 0~99.9 . (Unit s)

3.3.4 Parameters of the sewing machine (P4)

No.	Parameters	Initial	Instructions
-----	------------	---------	--------------

		values	
P4	Used to set parameters related to the sewing machine.		
P4.1	Sewing machine ON/OFF	OFF	ON/OFF optional; Set to "ON" to turn on the seaming function.
P4.2	Sewing machine start delay	0.5	After the sewing machine start switch is effective, start the sewing machine delay time. Range: 0.0~99.9 . (Unit s)
P4.3	Sewing machine output time	4.0	After the delay time arrives, start the output of the sewing machine and continue to output the output time of the sewing machine. Range: 0.0~99.9 . (Unit s)
P4.4	Cutter start delay	0.5	After the end of the output time of the sewing machine, start the cutting machine start delay time, and continue the cutting machine start delay time. Range 0.0~99.9 (unit s)
P4.5	Cutter output delay	0.5	After the start of the cutter, start the output of the cutter and continue the output delay time of the cutter. Range: 0.0~99.9 . (Unit s)
P4.6	Delay before stopping the sewing machine	0.5	After the work of the cutting machine is completed, the sewing machine continues to work, and the delay time before the sewing machine stops will be stopped. Range: 0.0~99.9 . (Unit s)
P4.7	Sewing machine to shake time	0.3	Prevent the photoelectric jitter of the startup of the sewing machine from causing the sewing machine to work abnormally. During the shaking time, the sewing machine will jitter photoelectric, but the output of the sewing machine is still effective at this time. Range: 0.0~99.9 . (Unit s)

3.3.5 Discharging Vibration Parameters (P5)

No.	Parameters	Initial values	Instructions
P5	Used to set discharge vibration related parameters.		
P5.1	Discharge vibration ON/OFF	OFF	ON/OFF optional; Set to "ON" to turn on the discharge vibration function. Discharging vibration can be divided into independent vibration and unloading door vibration.
P5.2	Effective discharge time	2.0	After the discharge vibration switch is opened, the effective discharge time is the period from the beginning of the output discharge signal to the completion of the discharge start discharge delay. When the discharge exceeds the effective discharge time, the discharge vibration function will be performed. Range 0.0 to 9.9 . (Unit s)
P5.3	Effective time of discharge vibration	0.5	Range 0.0 to 9.9 . (unit s).
P5.4	Unloading vibration ineffective time	0.5	Range 0.0 to 9.9 . (Unit s)
P5.5	Vibration times of discharge	10	Range 0 to 99 .

3.3.6 Auxiliary Pulse Parameters (P6)

No.	Parameters	Initial values	Instructions
P6	Used to set auxiliary pulse related parameters.		
P6.1	Auxiliary pulse switch	OFF	ON/OFF optional; Set it to "ON" to turn on the auxiliary pulse function.
P6.2	Auxiliary Pulse 1 Perform total time	0	Auxiliary Pulse 1 Perform the total time. If it is 0 , the loop will continue. Initial value: 0 ; Range : 0.0 to 999.9 . (Unit s)
P6.3	Auxiliary pulse 1 effective time	10.0	Range : 0.0 to 999.9 . (Unit s)
P6.4	Auxiliary Pulse 1 Ineffective time	10.0	Range : 0.0 to 999.9 . (Unit s)
P6.5	Auxiliary pulse 2 Perform total time	0.0	Auxiliary pulse 2 Perform total time. If it is 0 , execute all the time. Range: 0.0 to 999.9 . (Unit s)
P6.6	Auxiliary pulse 2 Effective time	10.0	Range : 0.0 to 999.9 . (Unit s)
P6.7	Auxiliary pulse 2 Ineffective time	10.0	Range : 0.0 to 999.9 . (Unit s)
P6.8	Auxiliary pulse 3 Perform total time	0	Auxiliary pulse 3 Perform total time. If it is 0 , execute all the time. Range : 0.0 to 999.9 . (Unit min)
P6.9	Auxiliary pulse 3 Effective time	10.0	Range : 0.0 to 999.9 . (Unit min)
P6.10	Auxiliary pulse 3 Ineffective time	10.0	Range : 0.0 to 999.9 . (Unit min)
P6.11	Auxiliary pulse 4 Perform total time	0	Auxiliary pulse 4 Perform total time. If it is 0 , execute all the time. Range : 0.0 to 999.9 . (Unit min)
P6.12	Auxiliary pulse 4 Effective time	10.0	Range : 0.0 to 999.9 . (Unit min)
P6.13	Auxiliary pulse 4 In-effective time	10.0	Range : 0.0 to 999.9 . (Unit min)

3.4 Working Parameters (Setup)

No.	Parameter	Initial value	Instructions
b1	Set basic weighing related parameters, such as clear zero range, such as clear zero range, stability, etc.		
b1.1	Automatic Zeroing after power-on	OFF	ON/OFF is optional. If this parameter is set to ON, the meter will be automatically cleared after it is powered on (the weight in the scale bucket meets the clearance range).
b1.2	Zero Range	50	Zeroable range. Range: 1 to 99 (percentage of full scale).
b1.3	Stable range	2	During the stabilization time, the weight change range within this setting value is judged to be stable. Range: 0 ~ 99(d) .
b1.4	Stable	0.3	Range: 0.1 to 9.9 . (Unit s)

	time		
b1.5	Zero point tracking tange	0	Weight value within this range, the meter automatically displays zero. Zero tracking is not performed when it is 0. The value ranges from 0 to 9(d) .
b 1.6	Zero point tracking time	2.0	Range: 0.1 to 99.9 (unit s)
b1.7	Digital filter rating	7	AD digital filter parameters: 7 : no filter; 9 : the strongest filtering effect. Range: 0 to 9
b1.8	Secondary filtering level	0	Secondary filtering based on digital filtering. Range: 0 to 9 .
b1.9	A/D sampling rate	240	A/D sampling rate, 120 times/s, 240 times/s, 480 times/s, 960 times/s optional.
b 2	Set the setting method, filtering level and other parameters.		
b2.1	PreFill Zero Interval	0	How many times to complete the packaging process for one zeroing. Enter the running state when the first packaging process, the instrument is not cleared. Range: 0 ~ 99 (Note: This parameter is only valid for bucket packaging mode)
b2.2	Result Check Mode	1	0 - Judge the stable value: After the slow feed is turned off, the weight is stable and the setting process is completed. 1 - Delay setting: After the slow feeding is closed, the setting process is completed after the fixed value holding time.
b2.3	Result Hold switch	OFF	ON/OFF optional; Set to "ON", the weight of the meter is fixed and maintained at the fixed weight after setting, and the real-time weight is displayed when the weight of the discharge (loose bag) is less than half the target value.
b2.4	Manual DISC To ACUM switch	OFF	ON/OFF optional; Set to "ON" and the manual unloading weight value is added to the cumulative value.
b2.5	Manual discharge judge pinch loose bag switch	OFF	When the bucket mode is stopped, set to "ON". When manually unloading, it is necessary to judge the bag pinch signal switch and allow unloading after the bag pinch. Note: Double bucket double bag AB independent, double bucket double bag AB combination mode, the manual discharge judgment bag release switch is opened, and the bag status of A scale and B scale are respectively detected during discharge .
b2.6	No bucket packaging mode	Net	Gross/Net packing (Net) optional; Net weight packaging mode At the beginning of quantification, the tare is cleared first, and the

			quantitative packaging process is carried out with the net weight value.
b2.7	Dynamic filter switch	ON	ON/OFF optional; During the packaging process, whether to filter the operation switch, set "ON", the following parameters are effective;
b2.7.1	Feed filter grade	4	Filtering parameters in the feeding process: 9 : the strongest filtering effect. Range: 0 ~ 9 .
b2.7.2	Result check Filter	7	Filtering parameters in the setting process: 9 : the strongest filtering effect. Range: 0 ~ 9 .
b2.7.3	Discharge filter grade	3	Filtering parameters in the unloading process: 9 : the strongest filtering effect. Range: 0 ~ 9 .
b3	Set the scale body structure, feed control and other parameters.		
b3.1	Scale structure	binyes	binyes (with bucket scale)/ bin no (without bucket scale)/ bulk (bulk scale) optional. Set the corresponding parameters according to the different scale body structure.
b3.2	Working mode	0	0 : AB double scale (with bucket) 1 : Separate A scale (with bucket, without bucket, bulk material) 2 : Separate B scale (with bucket, without bucket, loose material) 3 : Double bucket double pocket AB independent (with bucket) 4 : Double bucket double pocket AB combination (with bucket) 5 : AB independent (no bucket) 6 : AB combination (no bucket) 7 : AB stand alone (bulk) 8 : AB combination (bulk)
b3.3	The AB target value is switched separately	OFF	ON (ON) : A and B target values are set separately; OFF : target values are shared
b3.4	Feeding method	Co	Sin - separate feeding: fast time large feeding port feed; Feed in the feeding port when adding; Slow time small feeding port feed. Co -combined feeding: fast feeding large, medium and small feeding ports at the same time; When adding medium and small feeding port at the same time; Slow feed small feed port.
b3.5	No bucket double scale unlock Bag mode	OFF	Bag loosening mode optional: OFF (OFF) , simultaneous bag loosening normal mode (On1), simultaneous bag loosening fast mode (On2). ON 1 : Loose bag Normal mode For example, one scale has completed the feeding of the other scale has not completed the

			<p>feeding of the other scale, waiting for the completion of the two scales to loosen the bag at the same time.</p> <p>If a scale has been completed after feeding, the other scale is not in the bag (feeding) state, then do not wait for another scale, the scale directly loose the bag.</p> <p>ON 2: Fast mode of bagging</p> <p>The default A scale in this mode is in the front and B scale in the back. For example, A balance will not judge whether B is completed after feeding, and directly loosen the bag.</p> <p>After the completion of the feeding, B should judge whether A is in the state of bag clamping (feeding) : if A is feeding, B should wait for A to loosen the bag at the same time after adding; If A is not feeding, B does not need to wait for the bag to be loosened directly.</p> <p>OFF: disables this function</p> <p>Note: After this switch is turned on, the meter will not control the conveyor to start and stop. The external conveyor should be in operation at all times.</p> <p>If this switch is on and the pier bag function is enabled at the same time (F5.6 is not set to 0), the last beat bag output needs to wait for the AB scale to output at the same time, and then loosen the bag at the same time. [ON2 Mode A scale first completes first pier bag release]</p>
b3.6	Hopper Capacity	0.0	The bucket mode is valid, the maximum weight value of the weighing bucket is calculated with the target value
b3.7	Manual Unlock Bag	OFF	ON/OFF (optional); Set to "ON", running, you need to manually control the loose bag. Initial value: OFF (OFF) .
b3.8	Allow loose bag switch in operation	OFF	ON/OFF (optional); Set to "ON", no bucket mode, feeding, you need to manually control the loose bag. Initial value: OFF (OFF) . (Note: No bucket AB combination mode, this parameter and manual bag release switch can not be opened at the same time)
b3.9	Flow window length	3	That is, the number of samples to calculate the current flow value. The value ranges from 1 to 6 .
b3.10	Host discharge interlock switch	OFF	When set to ON indicates the main machine when multi-scale discharge interlock, OFF indicates the slave machine when multi-scale discharge interlock. The main machine controls the

			unloading from the slave machine.
--	--	--	-----------------------------------

3.5 Motor Parameters (Motor)

"Feed mode", Clamp/loose bag mode " and "Discharge mode" can select the motor mode and set the corresponding motor parameters. The **MODBUS** address area of motor parameters is **1000~1076** (**4x1001~4x1077**), [see the chapter 5.3.3 the MODBUS address assignment table.](#)

3.5.1 Charging Motor Parameters (U2)

No.	Parameters	Initial values	Instructions
U1	Set the feed motor mode parameters		
U1.1	Current recipe ID	01	Initial value: 01 ; Range: 01 to 40
U1.2	The number of the power unit used for this recipe	0	Initial value: 0 ; Range: 0 to 4
U2	Set the feed motor mode parameters		
U2.1	Feeding mode	Air	Optional: Air/motor1/motor2 1 Step-per motor feed; 2 , ordinary motor mod
U2.2	Filler Gate Close Overtime	4.0	Range: 0.0 to 99.9(s)
U2.3	Feed door closed in place signal type	0	Optional: 0/1 (in place if it works/in place if it doesn't)
U2.4	Feeding motor number	0	0 ~ 4
U2.5	A scale feeding motor frequency	12000	Range: 1 to 50000(Hz)
U2.6	A Scale Power-On Go 0 Pos. Freq	2000	Range: 1 to 50000(Hz)
U2.7	A Scale off to fine flow of pulses required	1800	Range: 1 to 60,000
U2.8	A Scale off to medium flow of pulses required	4300	Range: 1 to 60,000
U2.9	A scale off to coarse flow of pulses required	7750	Range: 1 to 60,000
U2.10	A scale open door rotation direction signal status	0	Optional: 0/1 (direction signal output is invalid when the feeding door is opened/direction signal output is valid when the feeding door is opened)
U2.11	B Scale feeding motor frequency	12000	Range: 1 to 50000(Hz)
U2.12	B scale Power-On Go 0 Pos. Freq	2000	Range: 1 to 50000(Hz)
U2.13	B Scale off to fine flow of pulses required	1800	Range: 1 to 60,000
U2.14	B Scale off to medium flow of pulses required	4300	Range: 1 to 60,000
U2.15	B Scale off to coarse flow of pulses required	7750	Range: 1 to 60,000
U2.16	B Scale open door rotation direction signal status	0	Optional: 0/1 (direction signal output is invalid when the feeding door is opened/direction signal output is

			valid when the feeding door is opened)
U2.17	A Scale feed motor start frequency	2000	Range: 1 to 50000(Hz) (this value cannot be greater than the A scale charging motor frequency)
U2.18	A Scale feed motor acceleration time	200	Range: 0 to 9999(ms)
U2.19	A Scale feed motor deceleration time	50	Range: 0 to 9999(ms)
U2.20	B Scale feed motor start frequency	2000	Range: 1 to 50000(Hz) (this value cannot be greater than the B scale charging motor frequency)
U2.21	B Scale feed motor acceleration time	200	Range: 0 to 9999(ms)
U2.22	B Scale feed motor deceleration time	50	Range: 0 to 9999(ms)
U2.23	A scale coarse flow opening time	0.8	Range: 0~99.99(s)
U2.24	A scale medium flow opening time	0.4	Range: 0~99.99(s)
U2.25	A Scale fine flow opening time	0.2	Range: 0~99.99(s)
U2.26	B Scale coarse flow opening time	0.8	Range: 0~99.99(s)
U2.27	B Scale medium flow opening time	0.4	Range: 0~99.99(s)
U2.28	B Scale fine flow opening time	0.2	Range: 0~99.99(s)
U2.29	Feeding does not require a switch in place	OFF	Range: OFF (OFF), ON (ON)
U2.30	A scale feed more pulses count	100	Range: 1 to 60,000
U2.31	B scale feed more pulses count	100	Range: 1 to 60,000

3.5.2 Bag locked/unlocked parameters (U3)

No.	Parameters	Initial values	Instructions
U3	Set the clip loose bag motor mode parameters		
U3.1	Clamp bag mode	Air	Optional: Air: Pneumatic mode; motor1 : Stepper motor clip loose bag; motor2 : Motor double limit clip loose bag; motor3 : Motor single limit clip loose bag.
U3.2	Loose bag process timeout	3.0	Range: 0 to 99.9(s)
U3.3	Clamp bag process timeout	3.0	Range: 0 to 99.9(s)
U3.4	Bag locked/unlocked in place signal type	0	Optional: 0/1(in place if it works/in place if it doesn't)

U3.5	A Scale clamp bag frequency	30000	Range: 1 to 50000(Hz)
U3.6	A Scale loose bag frequency	20000	Range: 1 to 50000(Hz)
U3.7	A scale Power-On Go 0 Pos. Freq	2000	Range: 1 to 50000(Hz)
U3.8	A Scale the number of pulses needed to clip the bag	12000	Range: 1 to 60,000
U3.9	A Scale clamper DIR signal type	0	Optional: 0/1 (direction signal output is invalid when bag is added/direction signal output is valid when bag is added)
U3.10	B Scale clamp bag frequency	30000	Range: 1 to 50000(Hz)
U3.11	B Scale loose bag frequency	20000	Range: 1 to 50000(Hz)
U3.12	B scale Power-On Go 0 Pos. Freq	2000	Range: 1 to 50000(Hz)
U3.13	B Scale the number of pulses needed to clip the bag	12000	Range: 1 to 60,000
U3.14	B Scale clamper DIR signal type	0	Optional: 0/1 (direction signal output is invalid when bag is held/direction signal output is valid when bag is held)
U3.15	A Scale clamp bag motor starting frequency	2000	Range: 1 to 50000(Hz) (this value cannot be greater than the A scale pocket frequency)
U3.16	A Scale clamp bag motor acceleration time	200	Range: 0 to 9999(ms)
U3.17	A Scale clamp bag deceleration time	50	Range: 0~9999(ms)
U3.18	B Scale clamp bag motor start frequency	2000	Range: 1 to 50000(Hz) (this value cannot be greater than the B scale pocket frequency)
U3.19	B Scale clamp bag motor acceleration time	200	Range: 0 to 9999(ms)
U3.20	B Scale clamp bag motor deceleration time	50	Range: 0 to 9999(ms)
U3.21	Loose bag opening effective time	0.5	Range: 0~99.99(s)
U3.22	Loose bag does not require a in place switch	OFF	Range: OFF (OFF), ON (ON)
U3.23	A scale loose bag for extra pulse count	100	Range: 1 to 60,000
U3.24	B scale loose bag for extra pulse count	100	Range: 1 to 60,000

3.5.3 Discharge parameters (U4) Valid in bucket mode)

No.	Parameters	Initial value	Instructions
U4	Set the discharge motor mode parameters		

U4.1	Discharging mode	Air	Optional: Pneumatic mode (Air); Stepper motor discharge (motor1); Motor single limit discharge (motor2); Motor double limit discharge (motor3); Motor unidirectional rotation discharge (motor4).
U4.2	Discharging and closing timeout	3.0	Range: 0.0 to 99.9(s)
U4.3	Discharging door timeout	3.0	Range: 0.0 to 99.9(s)
U4.4	Discharging position signal type	0	Optional: 0/1(in place if it works/in place if it doesn't)
U4.5	Discharge real-time detection switch	OFF	ON/OFF optional; Set to "OFF", the instrument does not need to always detect the discharge of the position signal, only need to run each time when the feeding test can be detected once the limit signal is detected, there is no need to detect the limit signal again; Set to "ON", real-time detection of the discharge motor is in the limit, if not, shield the feeding output, and alarm prompt, until the limit is detected before resuming the feeding.
U4.6	A Scale discharging opening frequency	30000	Range: 1 to 50000(Hz)
U4.7	A scale discharging closing frequency	20000	Range: 1 to 50000(Hz)
U4.8	A scale power back to zero frequency	2000	Range: 1 to 50000(Hz)
U4.9	A scale the number of pulses required for discharge	12000	Range: 1 to 60,000
U4.10	A scale discharge direction signal	0	Optional: 0/1(in place if it works/in place if it doesn't)
U4.11	B scale discharging opening frequency	30000	Range: 1 to 50000(Hz)
U4.12	B scale discharging closing frequency	20000	Range: 1 to 50000(Hz)
U4.13	B power back to zero frequency	2000	Range: 1 to 50000(Hz)
U4.14	B scale the number of pulses required for discharge	12000	Range: 1 to 60,000
U4.15	B scale discharge direction signal	0	Optional: 0/1(in place if it works/in place if it doesn't)
U4.16	A scale discharge motor start frequency	2000	Range: 1 to 50000(Hz) (this value cannot be greater than the unloading frequency of A scale)
U4.17	A scale discharging motor acceleration time	200	Range: 0 to 9999(ms)
U4.18	A scale discharging motor deceleration time	50	Range: 0 to 9999(ms)
U4.19	B Scale discharge motor start frequency	2000	Range: 1 to 50000(Hz) (this value cannot be greater than the discharge frequency of B scale)

U4.20	B Scale discharge motor acceleration time	200	Range: 0 to 9999(ms)
U4.21	B Scale discharge motor deceleration time	50	Range: 0 to 9999(ms)
U4.22	A scale discharge door output effective time	1.0	Range: 0~99.99(s)
U4.23	B scale discharge door output effective time	1.0	Range: 0~99.99(s)
U4.24	Discharging does not require a switch in place	OFF	Range: OFF (OFF), ON (ON)
U4.25	A scale discharge more pulses	100	Range: 1 to 60,000
U4.26	B Scale discharge extra pulse count	100	Range: 1 to 60,000

3.6 Communication Parameters (COM)







GMC-X904D provides two serial communication interfaces. Serial port outputs are defined in [Section 2.4](#). Set the port parameters correctly for communication.

The MODBUS address range for serial port communication **ranges from 0300 to 0309 (4x0301 to 4x0310)**. The following table describes the parameters. For network port communication parameters, the MODBUS address range is **1100 to 1111 (4x1101 to 4x1112)**. For details, [see the chapter 5.3.3 the MODBUS address assignment table](#).



No.	parameter	Initial value	State
RS-232	Set RS-232 communication parameters, including baud rate, communication protocol data format, etc., and print parameters.		
c1.1	Slave ID	1	1 to 99 Optional.
c1.2	Protocol	0	0- Modbus-RTU/1- Print /2- Continuous Mode /3- Re-ContA /4- Re-ContB Optional.
c1.3	Baud rate	38400	9600/19200/38400/57600/115200 is optional.
c1.4	Data format	8-E-1	Data bit - Parity check - stop bit; 8-E-1/8-N-1/7-E-1/7-N-1 Optional.
c1.5	Modbus High-low word	AB-CD	Modbus communication display mode AB-CD (high character in front)/ CD-AB (low character in front) Optional.
RS-485	Set RS-485 communication parameters, including baud rate, communication protocol data format, etc., and print parameters.		
c2.1	Slave ID	1	1 to 99 Optional.
c2.2	Protocol	0	0- Modbus-RTU/1- Print /2- Continuous Mode /3- Re-ContA /4- Re-ContB Optional.
c2.3	Baud rate	38400	9600/19200/38400/57600/115200 is optional.
c2.4	Data format	8-E-1	Data bit - Parity check - stop bit; 8-E-1/8-N-1/7-E-1/7-N-1 Optional.

c2.5	Modbus High-low word	AB-CD	Modbus communication display mode AB-CD (high character in front)/ CD-AB (low character in front) Optional.
------	----------------------	-------	---

3.7 Resetting Parameters (Reset)

symbol	Parameters	State
Reset All	Reset all parameters	Show Yes and press the button to restore all parameter values of the meter to their factory Settings.
Reset Setup	Reset working parameters	Show Yes and press the button  to restore the meter working parameter value to the factory setting value.
Reset CAL	Reset calibration parameters	Show Yes and press the button  to restore the meter calibration parameter value to the factory setting.
Reset Rec	Reset recipe parameters	Show Yes and press the button  to restore the meter recipe parameter values to their factory Settings.
Reset Per	Reset peripheral parameters	Show Yes and press the button  to restore the meter peripheral parameter values to their factory Settings.
Reset io	Reset IO quantity parameter	Show Yes , press the button  , restore the meter switch quantity define parameter value to the factory setting value.
Reset Motor	Reset motor parameters	Show Yes and press the button  to restore the meter motor parameter values to the factory Settings.
Reset Logic	Reset the auxiliary logic parameters	Show Yes and press the button  to restore the meter logic programming parameter values to their factory Settings.

3.8 System Parameters (Sys)

Symbols	Parameters	State
Sys Time	System time	View and set the time, year, month, and hour of the current system.
Sys Ver1	Background version	Check the time of the background version of the system.
Sys Ver2	Foreground version	Check the time of the foreground version of the system.
Sys IO Ver	IO version	View the system IO version.
Sys Bac	Parameter backup	Show Yes and press the button  to perform the parameter backup operation.
Sys Rld	Restore Parameter backup	Displays the time of the backup parameters and presses the button  to restore the backup parameters.

Sys Pwd	Password switch	Set password switch, set to ON, then modify the parameter such as enter the correct password (initial password 000000). Initial value: OFF ;
----------------	-----------------	---

3.9 IO module (IO)

The GMC-X904D provides **12** input and **16** output interfaces to connect the instrument to external devices. Among them: **OUT12, OUT13, OUT14, OUT15, OUT16** can be selected as high-speed **IO** control (**PWM**) output.

The **b3.1** item in the working parameters of the scale structure is not the same, the corresponding input and output outlet factory definitions are different, the content is as follows (output **1-16** corresponds to the instrument **OUT1~OUT16** interface, input **1-12** corresponds to the instrument **IN1~IN12** interface),

The default definition of a bucket scale:

Output (O def)		Amount of input (I def)	
Out1	1- Run	IN1	1- Start
Out2	2- Stop	IN2	2- Emergency stop
Out3	3- Scale A Coarse Flow	IN3	4- Scale A zero
Out4	4- Scale A Medium Flow	IN4	5- Scale B zero
Out5	5- Scale A Fine Flow	IN5	9-Scale A manual discharge
Out6	6- Scale B Coarse Flow	IN6	10-Scale B manual discharge
Out7	7- Scale B Medium Flow	IN7	6-Bag locked/unlocked request
Out8	8- Scale B Fine Flow	IN8	16- Clear alarm
Out9	10- Scale A value	IN9	11-A Manual slow add
Out10	13- Scale B value	IN10	12-B Manual slow add
Out11	11- Scale A discharge	IN11	15- Select recipes
Out12	14- Scale B discharge	IN12	3- Slow stop
Out13	9- Scale A bag locked		
Out14	15- Scale A pat bag		
Out15	23- Alarm		
Out16	25- Over		

No-Bucket scale Default definition:

Output (O def)		Amount of input (I def)	
Out1	1- Run	IN1	1- Start
Out2	2- Stop	IN2	2- Emergency stop
Out3	3- Scale A Coarse Flow	IN3	3- Slow stop
Out4	4- Scale A Medium Flow	IN4	4- Scale A zero
Out5	5- Scale A Fine Flow	IN5	5- Scale B zero
Out6	6- Scale B Coarse Flow	IN6	6-Bag locked/unlocked request
Out7	7- Scale B Medium Flow	IN7	7- Scale B bag locked/unlocked request
Out8	8- Scale B Fine Flow	IN8	29-Scale A manual fill (level)
Out9	10- Scale A value	IN9	30- Scale B manual fill (level)
Out10	13-Scale B value	IN10	11- Scale A manual Fine Flow
Out11	9- Scale A bag locked	IN11	12- Scale B manual Fine Flow
Out12	12- Scale B bag locked	IN12	16-Clear alarm
Out13	15- Scale A pat bag		
Out14	16- Scale B pat bag		
Out15	23- Alarm		
Out16	25- Over		

Bulk scale Default definition:

Output (O def)		Amount of input (I def)	
Out1	1- Run	IN1	1- Start

Out2	2- Stop	IN2	2- Emergency stop
Out3	3- Scale A Coarse Flow	IN3	3- Slow stop
Out4	4- Scale A Medium Flow	IN4	4- Scale A zero
Out5	5- Scale A Fine Flow	IN5	5- Scale B zero
Out6	6- Scale B Coarse Flow	IN6	9- Scale A manual discharge
Out7	7- Scale B Medium Flow	IN7	10- Scale B manual discharge
Out8	8- Scale B Fine Flow	IN8	29- Scale A manual fill (level)
Out9	10- Scale A value	IN9	30- Scale B manual fill (level)
Out10	13- Scale B value	IN10	11- Scale A manual Fine Flow
Out11	11- Scale A discharge	IN11	12- Scale B manual Fine Flow
Out12	14- Scale B discharge	IN12	16- Clear alarm
Out13	24- Batch completed		
Out14	27- Over/Under		
Out15	23- Alarm		
Out16	25- Over		

3.9.1 Output/Input Port Definition (IO def)

The contents of the output and input ports can be defined according to the actual application. The definition of the input and output switching parameters can be modified through the menu interface.

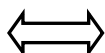

1. The switch quantity defines the operation

Input quantity definition

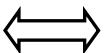

Enter the input definition interface.



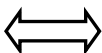

The first row shows the input function code, and the second row shows the input port. You can switch the input function code (10~157) through the up  and down  keys, the specific code meaning check the following Output/Input port definition. The other input port is defined in the same way.

Output definition

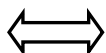
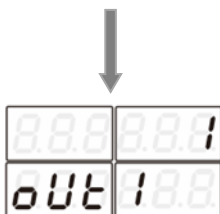

Go to the Output definition interface.



The first row shows the output function code, and the second row shows the output outlet. You can switch the output function code (00~076) through the up  and down  keys, the specific code meaning check the following switching content description. Other outputs are defined in the same way.

2. Switch quantity content description

Each switch quantity corresponds to a function code, as follows:

Output

Code	Content	Instructions
O0	Undefined	Undefined if output port is O0.
O1	Run	The output signal is defined valid in run status.
O2	Stop	The output signal is defined valid in stop status.
O3	Scale A Coarse Flow	To control large discharge opening of scale A filling system. If present weight value < target value – scale A Coarse Flow leading quantity in filling process, output signal is effective.
O4	Scale A Medium Flow	To control medium discharge opening of scale A filling system. If present weight value < target value – scale A Medium Flow leading quantity in filling process, output signal is effective.
O5	Scale A Fine Flow	To control slow discharge opening of scale A filling system. If present weight value < target value – scale A Fine Flow leading quantity in filling process, output signal is effective.
O6	Scale B Coarse Flow	To control large discharge opening of scale B filling system. If present weight value < target value – scale B Coarse Flow leading quantity in filling process, output signal is effective.
O7	Scale B Medium Flow	To control medium discharge opening of scale B filling system. If present weight value < target value – scale B Medium Flow leading quantity in filling process, output signal is effective.
O8	Scale B Fine Flow	To control slow discharge opening of scale B filling system. If present weight value < target value – scale B Fine Flow leading quantity in filling process, output signal is effective.
O9	Scale A bag locked	To control bag locked. Effective signal: bag locked. Ineffective signal: bag unlocked.
O10	Scale A value	Used to indicate scale A filling completed. During Fine Flow complete and material discharge (Net Weigher mode) or before pat bag (Gross Weigher), output signal is effective.
O11	Scale A discharge	To control hopper discharge gate. Output signal is effective when start discharging material from hopper A to bag.
O12	Scale B bag locked	To control bag locked system. Effective signal: bag locked. Ineffective signal: bag unlocked. Only effective in Gross Weigher mode.
O13	Scale B value	Used to indicate scale B filling completed. During Fine Flow complete and material discharge (Net Weigher mode) or before pat bag (Gross Weigher), output signal is effective.
O14	Scale B discharge	To control hopper discharge gate. Output signal is effective when start discharging material from hopper B to bag.
O15	Scale A pat bag	Used to control pat bag machine. The pulse width and times are controllable.
O16	Scale B pat bag	Used to control pat bag machine. The pulse width and times are controllable. (Only for Gross Weigher mode.)
O17	Scale A cut material	Output is effective only during scale A filling period.
O18	Scale B cut material	Output is effective only during scale B filling period.
O19	Filling	To control the filling system. When the low material level input defined invalid, the output is effective. When the upper material level defined valid, the output is ineffective.
O20	Lack of material	When the low material level input defined invalid, the output is effective. When the upper material level defined valid, the output is ineffective.
O21	Scale A zero zone	Output port defined effective if scale A current weight is smaller than near-zero value.
O22	Scale B zero zone	Output port defined effective if scale B current weight is

		smaller than near-zero value.
O23	Alarm	Output port defined effective if Over/Under or batch times are over.
O24	Batch completed	Output port defined effective if batch completed.
O25	Over	Signal is effective when over.
O26	Under	Signal is effective when under.
O27	Over/Under	Signal is effective when over or under.
O28	Conveyor output	To control conveyor starts and stop in Gross Weigher mode. Effective signal: start. Ineffective signal: stop.
O29	Coding /Scale A coding	Output this signal when coding delay over and bag locked output is effective.
O30	Scale B coding	Output this signal when coding delay over and bag locked output is effective. Only for Gross Weigher mode.
O31	Scale A filling pulse output	When the filling mode is set to a stepping motor controlled fill gate ON/OFF, the output signal is a pulse signal fed to the scale A stepper motor driver to control the motor rotation. Note: This function can only be defined on one of the port to OUT12~OUT16
O32	Scale A filling direction	When the filling mode is set to a stepping motor controlled fill gate ON/OFF, the output signal is a direction signal fed to the scale A stepper motor driver to control the motor rotation. Note: This function can only be defined on one of the port to OUT1~OUT11.
O33	Scale B filling pulse output	When the filling mode is set to a stepping motor controlled fill gate ON/OFF, the output signal is a pulse signal fed to the scale B stepper motor driver to control the motor rotation. Note: This function can only be defined on one of the port to OUT12~OUT16.
O34	Scale B filling direction	When the filling mode is set to a stepping motor controlled fill gate ON/OFF, the output signal is a direction signal fed to the scale B stepper motor driver to control the motor rotation. Note: This function can only be defined on one of the port to OUT1~OUT11.
O35	Scale A bag lock/unlock pulse output	When the bag lock mode is set to a stepping motor controlled bag locked or bag unlocked, the output signal is a pulse signal fed to the scale A stepper motor driver to control the motor rotation. Note: This function can only be defined on one of the port to OUT12~OUT16.
O36	Scale A bag lock/unlock direction signal	When the bag lock mode is set to a stepping motor controlled bag locked or bag unlocked, the output signal is a direction signal fed to the scale A stepper motor driver to control the motor rotation. Note: This function can only be defined on one of the port to OUT1~OUT11.
O37	Scale B bag lock/unlock pulse output	When the bag lock mode is set to a stepping motor controlled bag locked or bag unlocked, the output signal is a pulse signal fed to the scale B stepper motor driver to control the motor rotation. (Only for Gross Weigher mode) Note: This function can only be defined on one of the port to OUT12~OUT16.

O38	Scale B bag lock/unlock direction signal	When the bag lock mode is set to a stepping motor controlled bag locked or bag unlocked, the output signal is a direction signal fed to the scale B stepper motor driver to control the motor rotation. (Only for Gross Weigher mode) Note: This function can only be defined on one of the port to OUT1~OUT11.
O39	Scale A discharge pulse output	When the discharge mode is set to a stepping motor controlled discharging, the output signal is a pulse signal fed to the scale A stepper motor driver to control the motor rotation. Note: This function can only be defined on one of the port to OUT12~OUT16.
O40	Scale A discharge direction signal	When the discharge mode is set to a stepping motor controlled discharging, the output signal is a pulse signal fed to the scale A stepper motor driver to control the motor rotation. Note: This function can only be defined on one of the port to OUT1~OUT11.
O41	Scale B discharge pulse output	When the discharge mode is set to a stepping motor controlled discharging, the output signal is a pulse signal fed to the scale B stepper motor driver to control the motor rotation. Note: This function can only be defined on one of the port to OUT12~OUT16.
O42	Scale B discharge direction signal	When the discharge mode is set to a stepping motor controlled discharging, the output signal is a pulse signal fed to the scale B stepper motor driver to control the motor rotation. Note: This function can only be defined on one of the port to OUT1~OUT11.
O43	Scale A filling gate open	When the filling mode is set normal filling motor controlled the discharge gate, used to control large discharge gate opening of scale A. This signal is valid in filling process and the valid time can be set in the motor parameters.
O44	Scale B filling gate open	When the filling mode is set normal filling motor controlled the discharge gate, it used to control large discharge gate opening of scale B. This signal is valid in filling process and the valid time can be set in the motor parameters.
O45	Scale A filling gate closed	When the filling mode is set normal filling motor controlled the discharge gate used to control large discharge gate opening of scale A. This signal is valid in the end of Coarse/Medium/Fine Flow until filling limit is effective and the valid time can be set in the motor parameters.
O46	Scale B filling gate closed	When the filling mode is set normal filling motor controlled the discharge gate used to control large discharge gate opening of scale B. This signal is valid in the end of Coarse/Medium/Fine Flow until filling limit is effective and the valid time can be set in the motor parameters.
O47	Scale A bag unlock	When bag locked mode is set normal motor control bag locked/unlocked. Effective signal: bag unlocked. Ineffective signal: bag locked.
O48	Scale B bag unlock	When bag locked mode is set normal motor control bag locked/unlocked. Effective signal: bag unlocked. Ineffective signal: bag locked.
O49	Scale A discharge	When the discharge mode is set to discharge with a common

	gate closed	motor reversing controlling so as to control scale A discharge gate closing. Effective signal: discharge gate closed after discharging. Ineffective signal: stop closing.
O50	Scale B discharge gate closed	When the discharge mode is set to discharge with a common motor reversing controlling so as to control scale B discharge gate closing. Effective signal: discharge gate closed after discharging. Ineffective signal: stop closing.
O51	Sewing machine output	Sewing input valid, after the start delay of sewing ends, sewing output is valid.
O52	cutting machine output	Sewing output valid time ends, this output is valid, The valid time is the output valid time of the cutter
O53	Auxiliary pulse output 1	Auxiliary pulse 1 input valid, output pulse signal (valid time is auxiliary pulse 1 valid time, invalid time is auxiliary pulse 1 invalid time),stop output when the total execution time is up (If the total execution time is set to 0, the pulse output is always pressed) .
O54	Auxiliary pulse output 2	Auxiliary pulse 2 input valid, output pulse signal (valid time is auxiliary pulse 2 valid time, invalid time is auxiliary pulse 2 invalid time),stop output when the total execution time is up (If the total execution time is set to 0, the pulse output is always pressed) .
O55	Auxiliary pulse output 3	Auxiliary pulse 3 input valid, output pulse signal (valid time is auxiliary pulse 3 valid time, invalid time is auxiliary pulse 3 invalid time),stop output when the total execution time is up (If the total execution time is set to 0, the pulse output is always pressed) .
O56	Auxiliary pulse output 4	Auxiliary pulse 4 input valid, output pulse signal (valid time is auxiliary pulse 4 valid time, invalid time is auxiliary pulse 4 invalid time),stop output when the total execution time is up (If the total execution time is set to 0, the pulse output is always pressed) .
O57	A discharge patting output	It is used in the function of discharging patting. Under the running state, the function of starting patting under the condition of incomplete discharge can discharge the material completely.
O58	B discharge patting output	It is used in the function of discharging patting. Under the running state, the function of starting patting under the condition of incomplete discharge can discharge the material completely.
O59	Auxiliary logic Output 1	The output signal of the auxiliary logic output 1
O60	Auxiliary logic Output 2	The output signal of the Auxiliary logic output 2
O61	Auxiliary logic Output 3	The output signal of the Auxiliary logic output 3
O62	Auxiliary logic Output 4	The output signal of the Auxiliary logic output 4
O63	Auxiliary logic Output 5	The output signal of the Auxiliary logic output 5
O64	Auxiliary logic Output 6	The output signal of the Auxiliary logic output 6
O65	A Metering Hanger Up/Down	Metering Hanger Up/Down A output

O66	B Metering Hanger Up/Down	Metering Hanger Up/Down B output
O67	A Over /Under	When A exceeds or underranges, the output signal is defined as valid.
O68	B Over /Under	When B exceeds or underranges, the output signal is defined as valid.
O69	Last Feed	When the signal is valid, the current is the last feed.
O70	Tractor control	Connect the peripheral tractor. (Note: mainly used with peripheral traction machine, traction machine function see traction machine instrument manual)
O71	A weigh OK	Valid after setting, not at discharge
O72	B Weigh OK	Valid after setting, not at discharge
O73	Discharge status	Either A/B scale is valid when the machine is unloaded. Any one of the 6 scales on the main engine is valid for Hershey
O74	Allow discharge from machine 1	The discharge interlock is dedicated to the main machine and controls the discharge of the slave 1
O75	Allow discharge from machine 2	The discharge interlock is dedicated to the main machine and controls the discharge of the slave 2
O76	Discharge Request	Either A/B scale is valid when the slave machine is unloaded. Any one of the 6 scales on the main engine is valid for Hershey
O77	Lifting hooks	Used to control the lifting bag mechanism, the signal effectively realizes the lifting bag; The signal is invalid that loosens the hook. (The lifting bag can not be loosened during the feeding process, and the lifting bag can only be loosened after the pre-feeding process and the weighing process are completed. If the lifting bag is not defined, the lifting bag signal is not judged.) Note: need to be set by modbus address.
O78	Conveyor 2 Output	Control conveyor 2 output effective. Note: need to be set by modbus address.
O79	Conveyor 3 Output	Control conveyor 3 output effective. Note: need to be set by modbus address.
O80	Conveyor 1 Reverse the output	Control conveyor 1 reverse output effective. Note: need to be set by modbus address.
O81	Blow	Used to control the operation of the blowing device. Note: need to be set by modbus address.
O82	Return valve	Used to control the operation of the return air valve, the signal is effective when the blow is over. Note: need to be set by modbus address.
O83	Multipurpose stand	For the all-in-one control stand and beater bag. When not executing the beat-bag: This switching quantity is the same as the A metering bracket up (O65) state. When the bag is executed: This switching quantity is opposite to the state of the A bag (O15). (The patting bag effective bracket is invalid, and the patting bag invalid bracket is effective). Note: need to be set by modbus address.
O84	Discharging complete	After the end of the unloading delay, the signal will be output for a period of time, indicating that the unloading is completed. Note: need to be set by modbus address.
O85	Serial Controllable output 1	Control switch output 1 through serial port. Note: need to be set by modbus address.
O86	Serial Controllable	Control switch output 2 through serial port.

	output 2	Note: need to be set by modbus address.
O87	Serial Controllable output 3	Control switch output 3 through serial port. Note: need to be set by modbus address.
O88	Serial Controllable output 4	Control switch output 4 through serial port. Note: need to be set by modbus address.
O89	Serial Controllable output 5	Control switch output 5 through serial port. Note: need to be set by modbus address.
Input		
I0	Undefined	Undefined if input port is 00
I1	Start	This signal is valid in running status. (Pulse input signal)
I2	Emergency stop	Return to stop state if signal is valid. (Pulse input signal)
I3	Slow stop	Finish current package and then return to stop status. (Pulse input signal)
I4	Scale A zero	Clear zero of scale A if signal is effective. (Pulse input signal)
I5	Scale B zero	Clear zero of scale B if signal is effective. (Pulse input signal)
I6	Bag locked/unlocked request	To control bag locked/unlocked. Bag locked when first input this signal; bag unlocked if input the signal again.
I7	Scale B bag locked/unlocked request	To control bag locked/unlocked. Scale B bag locked when first input this signal; scale B bag unlocked if input the signal again. Only for Gross Weigher.
I8	Clear accumulated	To clear accumulated weight and times. Accumulated recipes and users total are cleared at the same time.
I9	Scale A manual discharge	Used to manually clear the material in the hopper. Scale A discharge output is valid when input signal is valid, but invalid if again.
I10	Scale B manual discharge	Used to manually clear the material in the hopper. Scale B discharge output is valid when input signal is valid, but invalid if again.
I11	Scale A manual Fine Flow	Scale A slow output is valid when first input this signal, invalid if input again.
I12	Scale B manual Fine Flow	Scale B slow output is valid when first input this signal, invalid if input again.
I13	Scale A manual filling	Combination filling mode: Scale A Coarse /Medium /Fine Flow output is valid when first time input the signal. Invalid if input again. Solo filling mode: Scale A Coarse Flow output is valid when first time input the signal. Invalid if input again.
I14	Scale B manual filling	Combination filling mode: Scale B Coarse /Medium /Fine Flow output is valid when first time input the signal. Invalid if input again. Solo filling mode: Scale B Coarse Flow output is valid when first time input the signal. Invalid if input again.
I15	Select recipes	Only valid once. Recipe changes to next one which target value is not zero.
I16	Clear alarm	Clear alarm output. (Pulse input signal)
I17	Upper level	To connect upper level of the hopper. (Level input)
I18	Under level	To connect under level of the hopper. (Level input) Lack materials if invalid. Unlack materials if valid.
I19	Start/Stop (Level)	Enter running status if signal is valid, return to stop status if invalid. This is level signal.
I20	Start/Slow stop (Level)	Enter running status if signal is valid, return to stop status if

		invalid. This is level signal.
I21	Scale A manual discharge (Level)	Manually clear the materials in the hopper. Scale A discharge output is valid if input is effective.
I22	Scale B manual discharge (Level)	Manually clear the materials in the hopper. Scale B discharge output is valid if input is effective.
I23	Bag Locked in pace	If the input is defined, valid means ready, invalid means not ready. Bucket scales mode: If bag locked in the running process, the controller will begin to discharge when bag locked ready. In discharge process, will not check the effectivity of signal. No-bucket scales r mode: If bag locked in the running process, the controller will begin to fill when bag locked ready. In filling process, will not check the effectivity of signal. This is level input.
I24	Scale B bag locked ready	If input signal is valid, means bag locked ready and invalid means bag locked not ready. Gross Weigher mode: The controller starts to fill once detect bag locked ready is valid. In filling process, will not check the effectivity of signal. This is level input.
I25	Scale A discharge gate closed ready	If the signal is valid, means scale A gate closed ready. If discharge real time detection set ON and detect invalid signal, will shield filling output and alarm, the output controller light will be off. If detect valid signal and have to fill, it will clear alarm automatically and continue to fill. If discharge real time detection set OFF and discharge gate closed not ready, it will alarm. Once detect valid signal, starting to fill.
I26	Scale B discharge gate closed	If the signal is valid, means scale B gate closed ready. If discharge real time detection set ON and detect invalid signal, will shield filling output and alarm, the output controller light will be off. If detect valid signal and have to fill, it will clear alarm automatically and continue to fill. If discharge real time detection set OFF and discharge gate closed not ready, it will alarm. Once detect valid signal, starting to fill.
I27	Scale A manual Fine Flow (level)	Effective signal: Scale A manual Fine Flow output is valid. Ineffective signal: Scale A manual Fine Flow output is invalid.
I28	Scale B manual Fine Flow (level)	Effective signal: Scale B manual Fine Flow output is valid. Ineffective signal: Scale B manual Fine Flow output is invalid.
I29	Scale A manual fill (level)	Combination filling mode: Scale A Coarse/Medium/Fine Flow output are valid if effective input. Solo filling mode: Scale A Coarse Flow output is valid if effective input.
I30	Scale B manual fill (level)	Combination filling mode: Scale B Coarse/Medium/Fine Flow output are valid if effective input. Solo filling mode: Scale B Coarse Flow output is valid if effective input.
I31	Scale A fill gate closed ready	When stepping motor controls filling gate ON/OFF, it is limit digit input signal for scale A filling gate closed ready. When normal motor controls filling gate ON/OFF, it is limit digit input signal for scale A filling gate closed ready. (Note: this signal is determined by the digit signal type. Pos-

		itive logic: The filling gate is closed if signal is valid. Negative logic: The filling gate is closed if signal is invalid.
I32	Scale B fill gate closed ready	When stepping motor controls filling gate ON/OFF, it is limit digit input signal for scale B filling gate closed ready. When normal motor controls filling gate ON/OFF, it is limit digit input signal for scale B filling gate closed ready. (Note: this signal is determined by the digit signal type. Positive logic: The filling gate is closed if signal is valid. Negative logic: The filling gate is closed if signal is invalid.)
I33	Scale A bag unlocked ready	It is a limit input signal of bag unlocked ready when stepping motor and motor double limit digit controlling bag locked/unlocked. (Note: this signal is determined by the digit signal type. Positive logic: Bag unlocked ready if signal is valid. Negative logic: Bag unlocked ready if signal is invalid.)
I34	Scale B bag unlocked ready	It is a limit input signal of bag unlocked ready when stepping motor and motor double limit digit controlling bag locked/unlocked. (Note: this signal is determined by the digit signal type. Positive logic: Bag unlocked ready if signal is valid. Negative logic: Bag unlocked ready if signal is invalid.)
I35	Scale A discharge gate opened ready	When material discharged is controlled by normal motor reversible double limit, it is a signal of discharge gate opening ready and discharge gate open.
I36	Scale B discharge gate opened ready	When material discharged is controlled by normal motor reversible double limit, it is a signal of discharge gate opening ready and discharge gate open.
I37	Sewing machine input	When this I/O Module input is valid, start sewing valid output (pulse signal).
I38	Sewing machine Emergency Stop	When this I/O Module input is valid, sewing stop output (level signal).
I39	Auxiliary pulse 1	The input is valid, the auxiliary pulse 1 output is valid, the second input is valid, and the auxiliary pulse 1 output is invalid
I40	Auxiliary pulse 2	The input is valid, the auxiliary pulse 2 output is valid, the second input is valid, and the auxiliary pulse 2 output is invalid
I41	Auxiliary pulse 3	The input is valid, the auxiliary pulse 3 output is valid, the second input is valid, and the auxiliary pulse 3 output is invalid
I42	Auxiliary pulse 4	The input is valid, the auxiliary pulse 4 output is valid, the second input is valid, and the auxiliary pulse 4 output is invalid
I43	Auxiliary logic input 1	Custom trigger input signal for auxiliary logic 1.
I44	Auxiliary logic input 2	Custom trigger input signal for auxiliary logic 2.
I45	Auxiliary logic input 3	Custom trigger input signal for auxiliary logic 3.
I46	Auxiliary logic input 4	Custom trigger input signal for auxiliary logic 4.
I47	Auxiliary logic input 5	Custom trigger input signal for auxiliary logic 5.

I48	Auxiliary logic input 6	Custom trigger input signal for auxiliary logic 6.
I49	Filling allow input	Filling allowed input: if filling allowed input is defined in the I/O Module, judge whether filling allowed input is effective before filling flow. If it is effective, the filling flow will be started. If it is not, wait.
I50	DISC allow input	DISC allow input is only for Net Weigher mode, if Disc allowed input is defined in the I/O Module, judge whether Disc allowed input is effective after waiting. If it is effective, the Disc flow will be started. If it is not, wait.
I51	B Filling allow input	Filling allowed input: if B filling allowed input is defined in the I/O Module, judge whether B filling allowed input is effective before filling flow. If it is effective, the filling flow will be started. If it is not, wait.
I52	B DISC allow input	DISC allow input is only for Net Weigher mode, if B Disc allowed input is defined in the I/O Module, judge whether B Disc allowed input is effective after waiting. If it is effective, the Disc flow will be started. If it is not, wait.
I53	A Metering Hanger Up/Down	When this input is valid, A Metering hanger upward is valid
I54	B Metering Hanger Up/Down	When this input is valid, B Metering hanger upward is valid
I55	Slave machine 1 Discharge request	The discharge interlock is dedicated to the host and is used to obtain the discharge request of slave 1.
I56	Slave machine 2 Discharge request	The discharge interlock is dedicated to the host to get the discharge request from slave 2.
I57	Discharge status from machine	Discharge interlock is special for the main machine, used to judge whether the slave machine is discharging.
I58	Congestion input	In bulk material accumulation mode, the material cannot be discharged when the congestion input is valid. Note: need to be set by modbus address.
I59	Bag hanging request	Used to control the action of the lifting mechanism. Note: need to be set by modbus address.
I60	Conveyor 1 Forward turn	In the stopped state, manually control the conveyor to start the forward turn. (When the SCram signal is effective, the forward turn output of conveyor 1 is invalid). Note: need to be set by modbus address.
I61	Conveyor 1 Reverse	Control the conveyor to start the reverse. (The conveyor 1 reverse output is not effective when the scam signal is in effect). Note: need to be set by modbus address.
I62	Conveyor 2 Limit	Conveyor 2 in place signal. Note: Need to be set by modbus address.
I63	Conveyor 3 Limit	Conveyor 3 position signal. Note: Need to be set by modbus address.
I64	Done manually	In the running state, the signal input is effective, the instrument automatically enters the fixed value, and the running state turns to slow stop. Note: need to be set by modbus address.
I65	Material level shielding	The signal works once, the meter shields the level function, works again, the meter lifts the level shield. Note: need to be set by modbus address.
I66	Enter flag 1	When the input is valid, there will be a corresponding state in the communication. The switch input state is mainly open for use. Note: need to set by modbus address.

I67	Enter flag 2	When the input is valid, there will be a corresponding state in the communication. The switch input state is mainly open for use. Note: need to set by modbus address.
I68	Enter flag 3	When the input is valid, there will be a corresponding state in the communication. The switch input state is mainly open for use. Note: need to set by modbus address.
I69	Enter flag 4	When the input is valid, there will be a corresponding state in the communication. The switch input state is mainly open for use. Note: need to set by modbus address.
I70	Enter flag 5	When the input is valid, there will be a corresponding state in the communication. The switch input state is mainly open for use. Note: need to set by modbus address.
I71	Start/E-Stop(RF)	If the signal is valid, the instrument will enter the running state, and if it is invalid, it will return to the stopping state. This input is an edge detection signal.
I72	Start/Stop RF)	If the signal is valid, the instrument will enter the running state. If it is invalid, it will return to the stopped state after completing the current packaging process. This input is an edge detection signal.

3.9.2 IO test (IO test)

The **IO** Test function is used to Test whether the output and input interfaces of the instrument are correctly connected to external devices. It is divided into input test (**I Test**) and output test (**O Test**).

Output test: register address **0323~0324** (4x0324~4x0325) , coil address **0093~0108**(0x0094~0x0109), [see the chapter 5.3.3 of MODBUS Address Assignment table.](#)

Write **1** in the corresponding position of the address, the corresponding external connection output state should be valid, if not, it indicates that the connection is abnormal, check the switching power input, wiring, etc.

Input port test: register address **0322** (4x0323) , coil address **0081~0092**(0x0082~0x0093), [see the chapter 5.3.3 of MODBUS Address Assignment table.](#)

When the external input is valid, the interface does not respond, it indicates that the connection is abnormal, check the switching power input, wiring, etc.

Input test

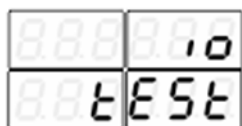

Enter the switch quantity TEST interface, display **io TEST**, press the button  to enter the input switch quantity test interface.



12 bit **F** is displayed to test the input switch quantity.



In the case that the external output is connected to the device, the **IN1** input is valid at this time, and the first bit of the switch quantity is **F** turn to **O**, indicating that the switch quantity is connected normally. The other bits are also tested in the same way. If the external input is valid and the interface does not respond, it proves that there is a problem with the hardware connection of the interface, and it is necessary to check the external connection again.

Output test

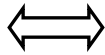
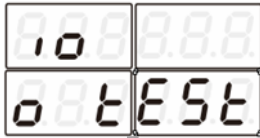

Output switch test interface.

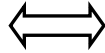
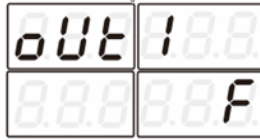

Take OUT1 as an example

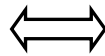

In the case that the external output is connected to the device, press , the output 1 character **F** to change to **O**, if the corresponding external output is valid, it means that this output is connected properly. The other outputs are also tested. Switch to **O**, if the external device does not respond, you need to check the outlet connection.

4. Function Description

4.1 Set work mode

The **GMC-X904D** has 3 scale structure configurations. The scale structure and working mode can be set under working Parameters (Set up). The structure of the scale body is optional: there are bucket scales, no bucket scales, bulk material scales.

Note: The working mode of the bucket-scale and the no bucket scales supports the dual scale interlock mode. Other scales do not support dual scale interlocking mode.

1. Working parameters When the structure of the scale body is set to a bucket, each working mode:

Working mode	There are bucket AB double scale	There is A bucket independent A scale	There are independent B scale	Double bucket double clip bag AB works independently	Double bucket double clip bag AB combination
The target value is set off separately	1) If the target value is greater than the maximum capacity of a single bucket, the target value of a single scale will be converted automatically; 2) Set the target value is less than or equal to the maximum capacity of a single bucket, and the single scale target value is the target value;				
The target value is set separately to open	Set the A/B target value to be less than or equal to the single bucket maximum capacity	Set the A goal value to be less than or equal to the maximum capacity per bucket	Set the target value B to be less than or equal to the maximum capacity of a single bucket	Set the target value A and B to be less than or equal to the maximum capacity of a single bucket	Set the target value of A and B can only be less than or equal to the maximum capacity of a single bucket

Note: 1) Double bucket double clip bag independent mode Double bucket double clip bag combination mode has two clip bag mechanism, when the double scale will start feeding at the same time.

2) The bucket mode generally uses the double scale working mode, and the rest mode is the fault operation mode.

2. Working parameters When the scale body structure is set to no bucket packaging:

Working mode	Target value setting
Dual scale independent working mode	The AB target value is set to off separately, and both AB use the target value
	The AB target values are set separately to on, and the A/B target values are used separately for AB
Dual scale combined working mode	AB target values are individually set to off, and both AB use target values
	The AB target value is set to ON separately, and the A/B target value for AB is used separately

4.2 Batches

The number of batches can be set by long button  2s under the main screen or **4x0102** at the modbus address.

Batch times are used to remind the number of packaging times. When the set batch times are completed in the process of automatic operation, the instrument will issue the batch times to alarm and stop, waiting for user processing, the batch times to and alarm output is effective, at this time the "clear alarm" input signal is effective, the instrument will clear the alarm. If the number of batches is set to **0**, the number of batches will not be judged.

Batch count ranges **from 0 to 9999**. The initial default value is **0** (no batch count judgment is made).

4.3 Filling Level Control

Due to the different application conditions, the installation of the level device of the packing scale storage bin is divided into two situations: double level (upper and lower level), single level (lower level) and no level.

4.3.1 Double level

Upper and lower levels are defined, corresponding to the double level situation. At this time, the instrument has the feed control function, the control principle is: when the input of the upper and lower level is invalid, the feed output of the instrument is effective; When the input of the feeding level is effective, the feeding output is invalid. At the same time, before each feeding (large, medium and slow feeding), the instrument will detect whether the feeding level is effective, if not, wait for this signal; Only when this signal is effective can the feeding process begin. During the feeding process, the meter does not detect whether the blanking level signal is valid.

4.3.2 Single feed level

The lower level is defined, the upper level is not defined, corresponding to the single level situation. At this time, the meter will not perform feed control. Only check the level before feeding, and wait for this signal if the level is invalid; Only when this signal is effective can the feeding process begin. During the feeding process, the meter does not detect whether the blanking level signal is valid.

The upper and lower level are not defined, corresponding to the case of no level. At this time, the instrument does not carry out feed control, and does not carry out the effective detection of the lower level before feeding.

4.4 Sewing control

The switching quantity involved in the function of the sewing machine is: the output switching quantity - "**sewing machine**", "**cutting machine**"; Input switch quantity - "**sewing machine input**", "**sewing machine emergency stop**".

Method **1** (the output time of the sewing machine is not **0**) : After the input (pulse) signal of the sewing machine is effective, the working process of the sewing machine begins. First, start the sewing machine startup delay. When the delay time is up, it is considered that the sewing machine is started **in place, and then output the sewing machine**. The output of the sewing machine is invalid after the delay time ends before the stop of the sewing machine. When **the delay** time of the start of the cutting machine reaches, the cutting machine starts to work, and the working time **is the output time of the cutting machine**. After the output time of the cutting machine reaches, the cutting machine stops working. The process is over.

Method **2** (the output time of the sewing machine **is 0**) : after the input (level) signal of the sewing machine is effective, the sewing machine start delay is carried out first. After the delay time, it will test again whether the startup input signal of the sewing machine is effective. If it is invalid, the output signal of the sewing machine will not be **output**. **The continuous output time is the output time of the sewing machine**. After the output time of the sewing machine arrives, the delay time before the start of the **sewing machine is stopped**, and the start **delay** time of the cutting machine is started. The sewing machine continues to work and output, and the duration is **the shutdown delay** time of the sewing machine. **The cutting machine start delay** time, when **the cutting machine start delay** time arrives, the cutting machine starts to work, the working time is **the output time of the cutting machine**, **the cutting machine** stops working after the output time of the cutting machine arrives.

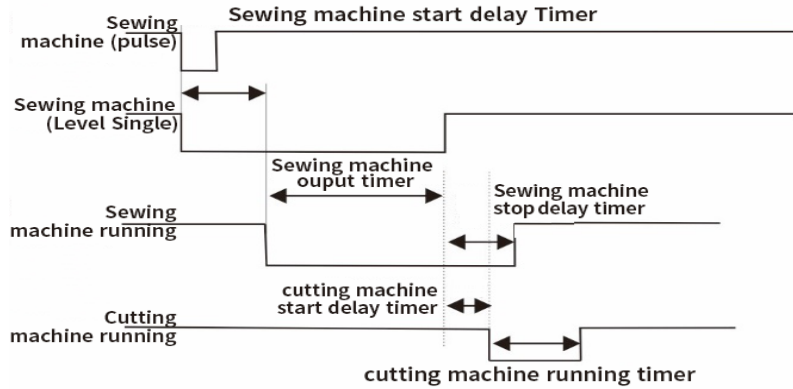

4.5 Discharge patting control

Independent vibration:

Take Scale A discharge patting function for example: The unloading vibration is an independent vibration. in the operate state; timing starts when discharge begins, when discharging time exceeds the set discharging valid time, the weight of the material in the hopper has not returned to the zero zone, at this time discharge patting A output is valid (this output is pulse, valid time is discharge patting valid time, invalid time is discharge patting invalid time). When discharge patting time is reach, the weight of the hopper is not lower than zero at this time, controller output discharging timeout alarm, back to stop state. When the discharge times of patting is not reached or just finished. When the weight of material in the hopper is less than zero zone value, start discharge delay time, delay to this weighing ends.

Discharging door vibration:

Take Scale A discharge patting function for example: unloading vibration is the vibration of the unloading door. At this point, the output control for the discharge door should be selected as A discharge patting output (the discharge vibration output at this time controls both the discharge door output and the discharge vibration (the vibration function is achieved by opening and closing the discharge door). In operating mode, when the device starts unloading, the "unloading vibration output" is effective and timing begins. When the unloading time exceeds the set unloading effective time and the weight of the material in the measurement has not returned to the zero zone, the unloading vibration A output is effective (this output is a pulse, the effective time is the unloading vibration effective time, and the invalid time is the unloading vibration ineffective time). After the number of unloading vibrations has reached, the current weight of the measuring hopper has not yet fallen below the zero zone, and the instrument outputs a timeout alarm for unloading, returning to the stopped state. When the number of unloading vibrations has not reached or just ended, and the weight of the material in the measuring hopper is less than the zero zone value, the unloading delay time will be activated. After the delay, the weighing will end.

4.6 Alarm function of filling and discharge overtime

Take scale A coarse flow filling overtime function for example: turn on filling and discharge overtime judge fuction, in the operate state, when Scale A starts coarse flow, starts timing, if scale A coarse flow time exceeds scale A coarse flow timeout time, controller output alarm, and back to stop state.

Take scale A discharge overtime function for example: turn on filling and discharge timeout judge function, in the operate state, when Scale A begins discharge, starts timing, if scale A discharge time exceeds scale A discharge timeout time, controller output alarm, and back to stop state.

4.7 Auxiliary pulse function

In the stopped or running state of the instrument, when the switching input **I39** (auxiliary

pulse **1**) is effective, the switching output **O53** (auxiliary pulse **1**) starts to output, the continuous output effective time is the output effective time of auxiliary pulse **1**, after the arrival of the time, stop the output, wait for the output invalid time of auxiliary pulse **1** after the arrival, start output again. Stop output until the total time of auxiliary pulse **1** is reached, and invalidate the input **I39** auxiliary pulse **1**. If the total execution time of auxiliary pulse **1** is set to **0**, the auxiliary pulse output process will continue to loop.

If the switching input **I39** (auxiliary pulse **1**) is valid during the auxiliary pulse execution, the output of auxiliary pulse **1** (**O53**) will stop.

4.8 Adaptive function

The adaptive function omits the manual adjustment of the lead step and can automatically adjust the feeding speed and accuracy. After this function is opened, it will automatically adjust the parameters of fast leading amount, leading amount, slow leading amount, fast forbidden time, adding forbidden time and slow forbidden time in the feeding process, so that the feeding speed and accuracy can be optimized. (When the **adaptive parameter update switch** is turned on, the instrument will display the current corrected parameters in real time)

Adaptive use:

Method 1: Set all the lead parameters (set the lead parameters, only need to be roughly accurate), the instrument will be on the basis of the current lead, according to changes in warehouse pressure, continue to modify the lead parameters, to achieve an optimal state. (Recommended to use this method)

Method 2: If all the current lead is **0**, when the first scale starts, the instrument will control the scale body and automatically find the corresponding lead parameters. The first scale may not be correct, but after several times of work, it will find the corresponding accurate lead and reach an optimal state.

Attention:

1. It is recommended to add a material level switch to ensure a stable material flow. The instrument also has the function of judging whether the material flow is stable, but it can not be judged successfully.
2. The drop correction and adaptive function can not be opened at the same time, if the adaptive function is opened, the drop correction function must be turned off first.
3. In the normal feeding process, if there is an occasional overshoot, you can consider increasing the adaptive level.

4.9 Hanger up control function

In no bucket mode, start the instrument, after the bag clamping, the instrument uplink signal output is effective, wait for the end of the uplink delay, start peeling (net weight mode), if the slap bag function is opened, then the uplink signal follows the slap bag signal output (if the slap bag output is invalid, the uplink is effective, the slap bag output is effective, the uplink is invalid), and the slap bag is the same after setting the value. The support uplink signal is invalid, the support goes down, start the **support down delay**, when the **support down delay** ends, start to loosen the bag.

When the instrument is in the stop state, when the support uplink signal is effective, the support goes up; When the support up signal is not effective, the support goes down.

4.10 Logic programming function

The auxiliary logic programming function can define up to **6** groups of auxiliary logic trigger signals, and can set the effective time and output port after the auxiliary logic signal is triggered, can configure simple logic signal output for controlling other auxiliary devices, and **6** groups of auxiliary logic signals can also control each other.

The logical programming parameters **MODBUS** address area is **1150~1258** (**4x1151~4x1259**), [see the chapter 5.3.3 the MODBUS address assignment table.](#)

Logic programming (1 to 6) parameter	Parameters	Instructions
1.Logic (1 to 6) types	Off (default)	Select the type of auxiliary logic programming signal based on the logic you want to implement.
	Delay turn-on	
	Delay disconnect	
	Delay on and delay off	
	Invalid-Valid jump edge trigger	
	Valid -Invalid jump edge trigger	
2. Logical (1 to 6) trigger signal	Custom trigger input (default)	If any input from channels 1 to 12 is set as the trigger signal, the input port is fixed as the trigger signal.
	>= or <= Weight value triggers	After setting the trigger condition, the current weight value is compared with the set weight threshold, and the output is triggered when the condition is met.
	Input ports 1 to 12	Set any one of the input ports 1 to 12 as a trigger signal, then the input can be either a trigger signal or a functional signal of the input port.
	Switch quantity output definition	After setting the trigger signal as "an internal function signal", the trigger output is carried out according to the function signal.
3. Trigger the input port	Enter ports 1 through 12	Initial value: undefined. (Note: The logic trigger signal is a custom trigger input, the parameter can be set) Select the switch input port corresponding to the function signal. The input port " 0 undefined" means that the function is not defined.
4. Output signal port	Output ports 1 to 16	Initial value: undefined. Select the switch output port corresponding to the function signal, and the output port " 0 undefined" means that the function is not defined.
5. Delay the on-time	Unit s	Initial value: 0.0 ; Range: 0.0 to 99.9 . After the trigger signal is valid, the logic output signal is valid only after the delay time. (Logic type is delay on and delay on and delay off, this parameter can be set)
6. Delay disconnect time	Unit s	Initial value: 0.0 ; Range: 0.0 to 99.9 . After the trigger signal is invalid, the logic output signal will be invalid after the delay time. (The logic type is delay disconnect and delay connect and delay disconnect, this parameter can be set)
7. Output the valid time	Unit s	Initial value: 0.0 ; Range: 0.0 to 99.9 . The duration of the logical output signal after the output is valid, which becomes invalid after the end of this time. (The logic type is invalid - valid jump edge and valid - invalid jump edge, this parameter can be set only)
8. Logical threshold weight	Consistent with the scale unit	Initial value: 0.00 ; Range: 0.0~ maximum range . Set the weight value, current weight and threshold weight comparison, triggered when the weight value trigger condition is met. (Valid when the trigger signal selects ">= or <= Weight value").

Delay turn-on

- When you select a delay switch [custom input port trigger], the operation is as follows:
 1. Set parameters and switch quantity: Type select [delay on], trigger signal if select

[custom trigger input], trigger input port is defined as "1" (you can see the switch input port 1 is displayed as "logic programming 1"), logic output port is defined as "1" (you can see the switch output port 1 is displayed as "logic programming 1"), set [delay on time] 2 seconds.

2. Execute the operation: make the trigger signal input 1 effective, start to take the delay turn-on time, and remain valid until the delay turn-on time 2s is over, the logic output signal port 1 output is effective, until the trigger signal input 1 is invalid, the logic output signal port 1 is also invalid. See the following time sequence diagram:

- When the delay switch [input port 1-12] is triggered, the operation is as follows:

1. Set parameters and switch quantity: Trigger signal select "input port 1" (you can see that the switch input port 1 is displayed as "original definition", assuming that the original definition is start, the function of the input port 1 can be "start" or "signal trigger"), the logic output port is defined as 1 (you can see the switch output port 1 is displayed as "logic programming 1"), [delay turn-on time] set 2 seconds.

2. Perform the operation: make the trigger signal input 1 effective (start is also effective, the instrument running output is effective), start to take the delay turn-on time, has been effective until the delay turn-on time is over 2s, the logic output signal port 1 output is effective, until the trigger signal input 1 is invalid, the logic output signal port 1 is also invalid. And the instrument will continue to run until the emergency stop signal is given.

- When the delay is switched on [switch output definition triggers], the operation is as follows:

1. Set parameters and switching quantity: trigger signal select "run" (switching quantity output can be defined or not defined running signal), the logic output port is defined as 1 (you can see the switching quantity output port 1 is displayed as logic programming 1), [delay switching time] set 2 seconds.

2. Execute operation: after the external input "start", when the "run" output signal is effective, start to go [delay turn-on time], which is valid until the delay turn-on time is over 2s, the logical output signal port 1 output is effective, until the "emergency stop or pause" is effective, that is, after the "run" output signal is invalid, the logical output signal port 1 becomes invalid.

- When you are selected to use delay to switch on [\geq or \leq weight value trigger], the operation is as follows:

1. Set the corresponding threshold weight, the logic output port is defined as 1 (you can see that the switching output port 1 is displayed as logic programming 1), and the [delay turn-on time] is set to 2 seconds.

2. Perform operation: When the current weight value \geq or \leq logic 1 threshold weight setting value is valid, start to go [delay turn-on time], and remain valid until the delay turn-on time 2s is over, the logic output signal port 1 output is valid, until the current weight $<$ or $>$ logic 1 threshold weight setting value logic output signal port 1 is invalid.

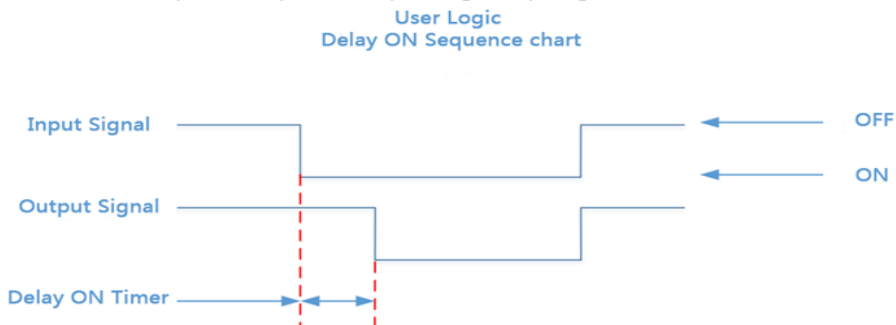

Delay disconnect

Related parameters: Type select [delay disconnect], select [trigger signal], set [trigger input port], [Logical output port definition], [Delay disconnect time]. For operation method,

refer to "Delay switch on". Its output function is shown in the following figure:

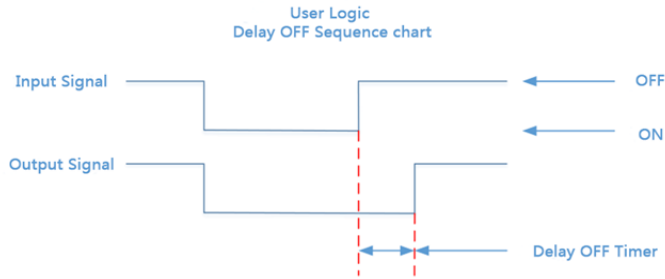

Delay switch on and delay disconnect

Related parameters: Type selection [Delay on and delay off], select [trigger signal], set [trigger input port], [Logical output port definition], [delay on time], [delay off time]. For the operation method, refer to "Delay on". Its output function is shown in the following figure:

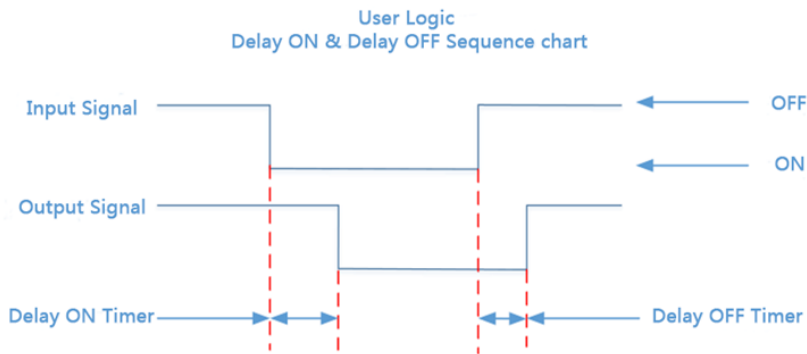

Invalid - Valid jump edge trigger

Related parameters: Type selection [Invalid - valid jump edge trigger], select [trigger signal], set [trigger input port], [logical output port definition], [delay turn-on time]. For the operation method, refer to "Delay turn-on". Its output function is shown in the following figure:

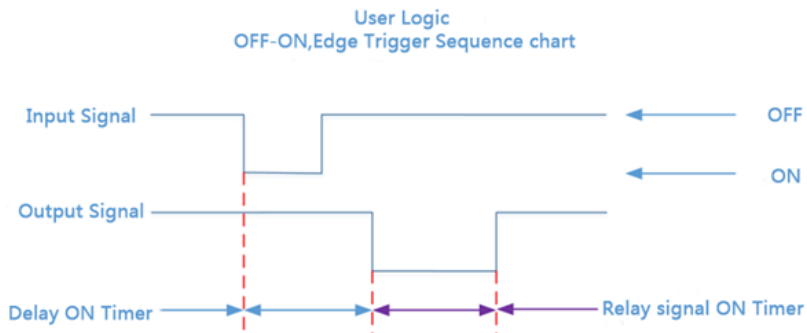

Valid - invalid jump edge trigger

Related parameters: Type selection [valid - invalid jump edge trigger], select [trigger signal], set [trigger input port], [logical output port definition], [delay turn-on time]. For the operation method, refer to "Delay turn-on". Its output function is shown in the following figure:

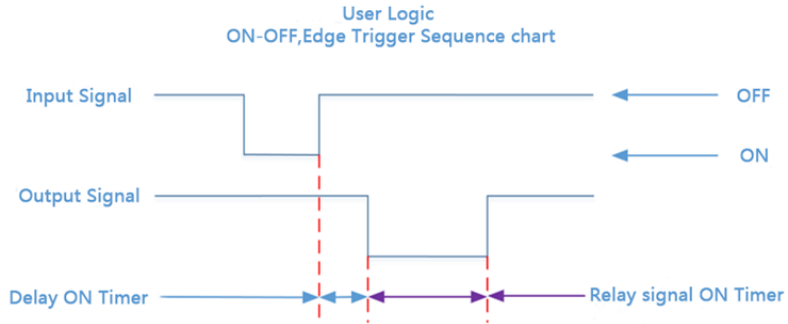

4.11 Character mapping table

The meter is displayed in two rows of 6-bit digital tubes, and the displayed English characters correspond to the following (case insensitive) :

a	b	c	d	e	f	g	h	i	j	k	l	m
A	b	C	d	E	F	G	H	,	J	K	L	ñ
n	o	p	q	r	s	t	u	v	w	x	y	z
n	o	P	q	r	S	t	U	v	w	x	y	z

4.12 Alarm information

<div style="border: 1px solid black; padding: 2px; display: inline-block;">Error</div>	Data out of range
	Zeroing failed
	Operation failed
<div style="border: 1px solid black; padding: 2px; display: inline-block;">-oFL</div> <div style="border: 1px solid black; padding: 2px; display: inline-block;">oFL</div>	Overflow -OFL: negative overflow; OFL: positive overflow
<div style="border: 1px solid black; padding: 2px; display: inline-block;">Modbus</div> <div style="border: 1px solid black; padding: 2px; display: inline-block;">Error</div>	Front - and back-end communication is interrupted

5. Serial communication

GMC-X904D can provide two serial communication interfaces, RS485 and RS232, continuous mode, Re-Cont mode, Modbus mode, printing mode, Re-ContA and Re-ContB is optional. For detail about serial port parameters, refer to chapter 3.6 communication parameters.

The instrument configuration communication mode switch:



When the switch is flipped to the user side, the instrument is set according to the parameters communication format for data communication. Dial to **the Default** terminal for data communication according to the fixed communication format: **38400** 8-N-1, MODBUS-RTU protocol.

5.1 Printing Method

When the serial communication mode is selected as the **printing** mode, the corresponding serial port can be connected to the serial printer to realize the printing of the related cumulative content.

The communication parameters related to the printing mode refer to the communication parameter items, which should be noted:

- 1) **Baud rate** -- The selection of this parameter should be consistent with the printer setting used in the connection.
- 2) **Communication Format** -- The selection of this parameter should be consistent with the printer setting used for the connection.

Note: When the printing language is selected as Chinese, do not use 7-bit data format, otherwise there will be an error in printing.

- 3) **Print format** - you can set the print format to **24** columns or **32** columns by communication parameters. In addition, the printing language can be set to Chinese or English.

5.1.1 Automatic printing

In print mode, the automatic print switch of communication parameters is set to on. Then the weighing result will be automatically printed after each weighing of the instrument is completed, the format is as follows:

In bucket and no-bucket scale mode, the printing format as follow:

English 24 print formats are as follows:

```
Packing list
Unit: kg
Recipe ID :      20
Total ACUM PCS
-----
1           5.50
2           5.50
```

English 32 print formats are as follows:

```
Packing list
Unit: kg
Recipe ID: 20
Total ACUM PCS                Result-
-----
3           5.60                5.50
4           6.00                5.80
```

In bulk scale mode, the format as follow:

English 24 print formats are as follows:
&

```
Receipt and delivery list
Scale No.: 1      Recipe ID: 1
Total: 0.00
Time: 2022/01/21 13:30
Unit: kg
-----
ACUM PCS          Results
```

English 32 print formats are as follows:
&

```
Receipt and delivery list
Scale No.: 1      Recipe ID: 20
Total: 0.00
Time: 2022/01/21 13:31
Unit: kg
ACUM PCS  Results  Total receipt/delivery
-----
```

12	13.58	21	13.58	240.40
13	13.58	22	13.58	253.98
14	13.58	23	13.58	267.5
15	13.58			

5.1.2 Total cumulative printing

In **print** mode, stop state, **write 1** at operation address **0310 (4x0311)**, perform the Print Total cumulative action. The format is as follows:

English 24 print formats are as follows:

Total ACUM Report
Time: 2018/6/19 13:28
Unit: kg

Total ACUM PCS: 18
Total ACUM: 84.16

English 32 print formats are as follows:

Total ACUM Report
Time: 2018/6/19 13:36
Unit: kg

Total ACUM PCS: 24
Total ACUM: 129.40

In bulk scale mode, the format as follow:

English 24 print formats are as follows:

Total ACUM Report
Scale No.: **1** Recipe No.: 1
Total: 0.00
Time: 2022/01/21 13:30

Flow rate:257.30t/h
Total receipt/delivery: 471.26kg
Total ACUM: 471.26kg

English 32 print formats are as follows:

Total ACUM Report
Scale No.: **1** Recipe No.: 1
Total: 0.00
Time: 2022/01/21 13:31

Flow rate:257.30t/h
Total receipt/delivery: 471.26kg
Total ACUM: 471.26kg

5.1.3 Recipe cumulative printing

In the printing mode, in the stop state, **write "1~40"** in the operation address **0311 (4x0312)**, perform the action of printing the corresponding formula accumulation, write "41" to print all the formula accumulation values (automatically skip the formula whose target value is 0). Format is as follows:

English 24 print formats are as follows:

Recipe ACUM Report
Time: 2018/6/19 13:29
Unit: kg

Recipe Number: 20
ACUM PCS of recipes: 18
Recipe ACUM Weight: 84.16

English 32 print formats are as follows:

Recipe ACUM Report
Time: 2018/6/19 13:36
Unit: kg

Recipe Number: 20
ACUM PCS of recipes: 24
Recipe ACUM Weight: 129.40

5.1.4 User Cumulative printing

In the printing mode, stop state, operation address **0312 (4x0313)** write **"0~9"**, perform the corresponding user accumulation action, write "100" to print the current user accumulation, write "101" to print the cumulative value of all users (automatically skip the user whose target value is 0). Format is as follows:

English 24 print formats are as follows:

User ACUM Report

Time: 2018/6/19 13:29
 Unit: kg

 User ID: 9
 User ACUM PCS: 16
 User ACUM Weight: 72.26

English 32 print formats are as follows:

User ACUM Report
 Time: 2018/6/19 13:37
 Unit: kg

 User ID: 9
 User ACUM PCS: 22
 User ACUM Weight: 117.50

5.2 Continuous Mode

The communication mode of serial port RS485 or RS232 is continuous mode, and the instrument will send out the instrument result through the selected serial port.

5.2.1 Data frame format is as follows:

STX	Scale No.	R	T	SP	SP	ACUM PCS	,	ACUM weight	CRC	CR	LF
------------	-----------	----------	----------	-----------	-----------	----------	---	-------------	------------	-----------	-----------

Where:

R -- 52H;

T -- 54H;

SP -- 20H;

ACUM PCS -- **9** digits, **00000000~99999999;**

ACUM weight -- **10** digits, including decimal points;

Example: The meter emits the following data (in hexadecimal);

02 30 31 52 54 20 20 20 20 20 20 20 20 31 30 30 2C 20 20 20 20 30 2E 35 30 30 30 32 39 0D 0A

It said:1# scale, the current cumulative number is **100**, the cumulative weight is **0.5000**.

5.3 Modbus-RTU protocol

The mode of communication parameters is **Modbus-RTU**.

5.3.1 Function code and exception code

◆ Function codes supported by the instrument:

Function codes	Name	Instructions
03	Read registers	Read up to 125 registers at a time
06	Write a single register	
16	Write multiple registers	This instrument This command only supports writing double registers. The address must be aligned when writing. Only a part of the double register is not allowed to be written.
01	Read coil	Note that this length is in bits
05	Write coil	

Note: This meter only supports the above **MODBUS** function codes, the meter will not respond when other function codes are fed to the meter.

◆ **MODBUS** exception code response

CODE	Name	Meaning
------	------	---------

02	Illegal data address	For this meter, the error code indicates that the received data address is an impermissible address.
03	Illegal data values	The portion of data written and the allowable range.
04	Slave failure	An unrecoverable error occurs when the meter is attempting to perform the requested operation.
07	Unsuccessful programming request	For the meter, the command received cannot be executed under the current conditions.

5.3.2 MODBUS Transmission Mode

The **MODBUS** transmission mode is **RTU** mode.

When communicating in **RTU** mode, each **8-bit** byte in the message is divided into **2 4-bit hexadecimal** characters.

Data format: **8-bit** data bit, **1-bit** stop bit, parity check (**8-E-1**)

8-bit data bit, 1-stop bit, no check (**8-N-1**)

Baud rate: **9600/19200/115200/38400/57600** (choose one)

Code: **RTU**

5.3.3 MODBUS address assignment

Protocol Address	PLC address	Meaning	Instructions	
The following is a read-only register				
0000-0001	40001-40002	A Scale the current weight	The weight display of scale A on the meter	
0002-0003	40003-40004	A Scale current weight status	Bit	Instructions
			D0	Weight unstable: 0; Stable: 1
			D1	Non-zero: 0; Zero: 1
			D2	The symbol +/- that currently displays the weight. Plus sign: 0; Negative sign: 1
			D3	Overflow
			D4	Positive weight overflow
			D5	Weight negative overflow
			D6	Sensor positive overflow
			D7	Sensor negative overflow
			D8	Millivolts stable: 1; Unstable: 0
D9~31	Reserved			
0004-0005	40005-40006	B Scale the current weight	The weight display on the B scale on the meter	
0006-0007	40007-40008	B Scale current weight status	D0	Weight unstable: 0; Stable: 1
			D1	Non-zero: 0; Zero: 1
			D2	The symbol that currently displays weight +/- plus sign: 0; Negative sign: 1
			D3	Overflow
			D4	Weight positive overflow
			D5	Weight negative overflow
			D6	Sensor positive overflow
			D7	Sensor negative overflow
			D8	Millivolts stable: 1; Unstable: 0
			D9~31	Reserved
0008-0009	40009-40010	AB Scale Common control status	D0	0: Stop; 1: Run.
			D1	Alarm
			D2	Batch completed
			D3	pocket
			D4	Loading position
			D5	Blanking position
			D6	For feeding

			D7	Underfeed
			D8	Patter bag
			D9	Conveyor output (no bucket)
			D10	Coding output
			D11	Sewing machine output
			D12	Tangential output
			D13	Auxiliary Pulse 1
			D14	Auxiliary Pulse 2
			D15	Auxiliary Pulse 3
			D16	Auxiliary Pulse 4
			D17	Relay output 1
			D18	Relay Output 2
			D19	Relay output 3
			D20	Relay output 4
			D21	Relay output 5
			D22	Relay output 6
			D23	Slow Stop
			D24	A bracket up
			D25	B Bracket up
			D26	Last Scale
			D27	Congestion input
			D28	Lifting bag
			D29	Unloading complete
			D30-31	Reserved
0010-0011	40011-40012	A Scale current control status	D0	A Before adding
			D1	A Quick Add
			D2	A Canada
			D3	A Slow Add
			D4	A fixed value
			D5	A Unloading
			D6	A zero zone
			D7	A Out-of-tolerance
			D8	A underbalance
			D9	A Qualified
			D10	A Overunderbalance pause
			D11	A scale clip bag (no bucket)
			D12	A scale bat bag
			D13	A Code output
			D14	Gross Net weight Status Gross weight: 0; Net weight: 1
			D15	A Discharge vibration
			D16	A Weigh up
D17	A Unloading complete			
D18-31	Reserved			
0012-0013	40013-40014	B Scale current control status	Refer to "Current control status of Scale A"	
0014-0015	40015-40016	Total cumulative weight (0~999999999)		
0016-0017	40017-40018	Total cumulative number of packets (0 to 999,999,999)		
0018-0019	40019-40020	Current recipe Cumulative weight (0~999999999)		
0020-0021	40021-40022	Current recipe Cumulative packets (0~999999999)		
0022-0023	40023-40024	User accumulated weight (0~999999999)		

0024-0025	40025-40026	Cumulative number of packets for users (0 to 999,999,999)	
0026-0027	40027-40028	A Weight on the previous scale	
0028-0029	40029-40030	B Weight on previous scale	
0030	40031	A Scale alarm information	<ul style="list-style-type: none"> 0. No alarm 1. Formula setting is not reasonable, can not start; 2. Single bucket maximum capacity is 0, can not start; 3. The weight exceeds the clearance range when clearing; 4. The weight is unstable when clearing; 5. Over and under alarm; 6. Single scale target value can not be set to 0 maximum range is too large; 7. The single scale target value is greater than the maximum capacity of a single bucket; 8. Weight overflow or sensor overflow when starting; 9. Discharge door out of limit 10. No pinch bag (manual unloading judgment pinch bag opened, manual unloading unpinch bag will prompt no pinch bag, no pinch bag in operation) 11. Zero clearance during operation 12. Clear during operation out of range 13. Running clear is unstable 14. Motor parameter setting is not reasonable (ordinary motor) 15. Reservation
0031	40032	B Scale alarm information	Refer to A scale alarm information
0032-0033.	40033-40034.	Regular Alarm Information (Needs to be cleared manually) (Modifications of high and low bytes do not affect this status bit)	<ul style="list-style-type: none"> 0- No alarm; 1- Batch times completed; 2- A over and underbalance suspended; 3- B hyperunderbalance pause; 4- A balance motor charging door closed timeout alarm 5- B balance motor charging door closing timeout alarm 6- A balance bag timeout alarm 7- B balance bag timeout alarm 8- A balance loose bag timeout alarm 9- B balance loose bag timeout alarm 10- A balance unloading and closing time alarm 11- B balance unloading and closing time alarm 12- A balance unloading door timeout alarm 13- B balance unloading door timeout alarm 14- A balance charging door is not closed in place alarm 15- B scale charging door is not closed in place to alarm 16- The unloading door of A scale is not closed in place to alarm 17- B scale discharge door is not closed in place to alarm 18- Motherboard and additional version communication abnormal alarm 19- A scale quickly add timeout alarm 20- Scale B fast overtime alarm 21- Scale A add timeout alarm 22- B balance will add overtime alarm 23- A scale slow and overtime alarm 24- B scale slow and overtime alarm

			<p>25- A balance unloading time alarm</p> <p>26- Balance B unloading time alarm</p> <p>27- A balance unloading vibration timeout alarm</p> <p>28- Balance B unloading vibration timeout alarm</p>	
0034	40035	AB Calibration alarm message (modification of high and low bytes does not affect this status bit)	<p>0- No alarm</p> <p>1- The maximum range is too small</p> <p>2- The maximum range is too large</p> <p>3- Voltage at zero is too high</p> <p>4- Zero point voltage too low</p> <p>5- Mark zero is unstable</p> <p>6- The gain voltage is too high</p> <p>7- Gain voltage is too small</p> <p>8- The scale table is unstable</p> <p>9- Weight input error</p> <p>10- Resolution is too small after calibration (lack of accuracy)</p> <p>11- Please manually feed and then manually unload (material calibration alarm)</p> <p>12- Reserve</p>	
0035	40036	A scale before fast add time; Unit: s		
0036	40037	A Add time to the previous scale; Unit: s		
0037	40038	A scale before slow add time; Unit: s		
0038	40039	A scale the previous scale set time; Unit: s		
0039	40040	A scale before unloading time; Unit: s		
0040	40041	A scale the total time of the previous scale; Unit: s		
0041	40042	B Scale the previous scale quickly add time; Unit: s		
0042	40043	B Add time to the previous scale; Unit: s		
0043	40044	B Scale before slow add time; Unit: s		
0044	40045	B scale the previous scale value time; Unit: s		
0045	40046	B the unloading time of the previous scale; Unit: s		
0046	40047	B The total time of the previous balance; Unit: s		
0047	40048	A scale packing complete mark; Initial value: 0,0 ~9999(this value is not saved)		
0048	40049	B Scale packing complete mark; Initial value: 0,0 ~9999(this value is not saved)		
0049	40050	Reserved		
The following are readable and writable registers				
Calibration parameter				
0050	40051	Units	Initial value: 1; 0 -- g; 1 -- kg; 2 -- t; 3: lb(lb)	
0051	40052	Decimal point	Initial value :2; 0-0; 1-0.0; 2-0.00; 3 -- 0.000; 4-0.0000	
0052	40053	Division value	Initial value: 1, (1/2/5/10/20/50)	
0053-0054	40054-40055	Maximum range	Initial value: 10000, range (maximum range \leq minimum index value \times 100000, and not greater than 999999)	
0055-0056	40056-40057	A scale is calibrated with weights	There is zero weight calibration	When writing 1, the current weight is regarded as zero, and it is allowed to write when the weight of the scale is stable; Return the current zero millivolt when reading.
0057-0058	40058-40059		With weight gain calibration	Input standard weight (\leq maximum range); Read as the current sensor relative zero millivolts
0059-0060	40060-40061	A scale no weight	Zero calibration without	Write the millivolt value that will be calibrated to zero;

		calibration	weight	Returns the current zero millivolts when reading.
0061-0062	40062-40063		Weightless gain calibration (gain millivolt value)	Write the millivolt number corresponding to the gain weight, and the meter is temporarily stored; When reading, return the absolute millivolt corresponding to the current weight (0XFFFF if the current millivolt is too small or too large to calibrate).
0063-0064	40064-40065		Weightless gain calibration (gain weight value)	Write the weight value corresponding to the gain millivolts. The gain millivolts must be written before writing the value. The two are used for gain calibration when writing the register. Return 0000H when reading.
0065-0066	40066-40067	B scales are calibrated with weights		Refer to "A scale with weights calibration zero"
0067-0068	40068-40069			See "A Scale with Weights Calibration Gain"
0069-0070	40070-40071	B scale no weight calibration		Refer to "A scale without weight calibration zero"
0071-0072	40072-40073			See "A weighless Gain Calibration (Gain millivolt value)"
0073-0074	40074-40075			Refer to "A Scale Weightless Gain Calibration (Gain weight value)"
0075-0076	40076-40077	Manual feeding time		Initial value: 0 Range: 0.0~9.9
0077-0078	40078-40079	A Scale material calibration		Click on the material calibration manual discharge, input the corresponding weight, read as 0. (Note: It can only be used in material calibration).
0079-0080	40080-40081	B Scale material calibration		Click on the material calibration manual discharge, input the corresponding weight, read as 0. (Note: It can only be used in material calibration).
0081-0099	40082-40100	Reserve		
Other parameter items				
0100	40101	Recipe number		Initial value: 1, range: 1-40
0101	40102	Batch times		Initial value: 0, range: 0 to 9999
0102	40103	Cumulative batch		Read Only
0103	40104	Locking machine		0 - unlocked machine; 1 - locked machine
0104	40105	years		0-99.
0105	40106	month		1-12
0106	40107	day		1-31
0107	40108	when		0-23
0108	40109	points		0-59
0109	40110	seconds		0-59
0110 ~ 0119	Reserve			
Recipe parameters - Quantitative parameter Settings				
0120-0121	40121-40122	Total target value		Weight value written range: ≤ maximum range
0122-0123	40123-40124	A Target value		When there is a bucket: Weight value write range: ≤ single bucket maximum capacity No bucket: Weight value written range: ≤ maximum range
0124-0125	40125-40126	B Target value		
0126-0127	40127-40128	A Co-Fi Remain		
0128-0129	40129-40130	A Me-Fi Remain		
0130-0131	40131-40132	A Free Fall		
0132-0133	40133-40134	B Co-Fi Remain		

0134-0135	40135-40136	B Me-Fi Remain	
0136-0137	40137-40138	B Free Fall	
0138-0139	40139-40140	Zone Zero values	
Recipe parameters - time parameters			
0140	40141	Filling Start Delay	Initial value: 0.5 s, range: 0.0 ~ 99.9s
0141	40142	A.COMP. Inhibit Timer(Co-F)	Initial value: 0.9 s, range: 0.0 ~ 99.9s
0142	40143	A. COMP. Inhibit Timer(Me-F)	Initial value: 0.9 s, range: 0.0 ~ 99.9s
0143	40144	A. COMP. Inhibit Timer(Fi-F)	Initial value: 0.9 s, range: 0.0 ~ 99.9s
0144	40145	B.COMP. Inhibit Timer(Co-F)	Initial value: 0.9 s, range: 0.0 ~ 99.9s
0145	40146	B. COMP. Inhibit Timer(Me-F)	Initial value: 0.9 s, range: 0.0 ~ 99.9s
0146	40147	B. COMP. Inhibit Timer(Fi-F)	Initial value: 0.9 s, range: 0.0 ~ 99.9s
0147	40148	Over/Under detection Timer	Initial value: 0.5 s, range: 0.0 ~ 99.9s
0148	40149	Result Waiting Timer	Initial value: 0.5 s, range: 0.0 ~ 99.9s
0149	40150	Discharge Delay Timer	Initial value: 0.5 s, range: 0.0 ~ 99.9 s
0150	40151	Discharge interlock time	Initial value: 0.5 s, range: 0.0 ~ 99.9s
0151	40152	Bag Locked Delay Timer	Initial value: 0.5 s, range: 0.0 ~ 99.9s
0152	40153	Unlock Bag Pre-Delay Timer	Initial value: 0.5 s, range: 0.0 ~ 99.9s
0153	40154	Supplement Empty On Timer	Initial value: 0.5 s, range: 0.0 ~ 99.9s
Recipe parameters - over and under parameters			
0154	40155	Over/Under detection ON/OFF	Initial value: 0,1: on 0: off
0155	40156	Over/Under pause ON/OFF	Initial value: 0,1: on 0: off
0156-0157	40157-40158	Over value	Weight value written range: ≤ maximum range
0158-0159	40159-40160	Under value	
0160	40161	Supplement material ON/OFF	Initial value: 0,1: on 0: off
0161	40162	Supplement material times	Range: 1 to 99. Initial value: 1
0162	40163	Effective supplement time	Initial value: 0.5 seconds, range: 0.0 ~ 99.9
0163	40164	Ineffective supplement time	Initial value: 0.5 seconds, range: 0.0 ~ 99.9
Formula parameters - Drop correction parameters			
0164	40165	Free fall correction ON/OFF	Initial value: 0,1: on 0: off
0165	40166	Correction sampling times	Range: 1 to 99. Initial value: 1
0166	40167	Free fall correction range	Range: 2.0, range: 0.0 ~ 9.9,

0167	40168	Free fall correction magnitude	Initial value: 1,0 --100% correction; 1--50% correction; 2-25% correction.
0168	40169	Parameters update ON/OFF	0: No refresh (initial value) 1: Refresh in real time
0169	40170	Hanger Up Delay Timer	Initial value: 0.0, range: 0-99.9
0170	40171	Hanger Down Delay Timer	Initial value: 0.0, range: 0-99.9
0171	40172	Quick feed mode	Initial value: 0,1: on 0: off
0172	40173	Fast Mode Time	Initial value: 0, range: 0-1000ms
0173-0174.	40174-40175.	Fast Mode Weight A	Initial value: 0, range: 0.0- maximum range
0175	40176	Number of quick pattern fixes	Initial value: 5, range: 0-10
0176	40177	Fast mode stabilization time	Initial value: 100, range: 0.0-1000
0177-0178.	40178-40179.	Fast Mode Weight B	Initial value: 0, range: 0.0- maximum range
0178	40179	Reserve	
0179	40180	Discharging completion delay	Initial value: 0, range: 0-99.9
0180	40181	Switch for multiple scales with a bucket	Initial value: 0,1: on 0: off
0181	40182	Blowing mode	Initial value: 0, range: 0-1 0: blowing before uplink delay 1: blowing after uplink delay
0182	40183	Return valve way	Initial value: 0, range: 0-1 0: Close the air return valve after discharge 1: close the air return valve after loosening the bag
0183	40184	Blow time	Initial value: 0.5, range: 0.0-99.9
0184	40185	Hook reset delay	Initial value: 0.0, range: 0.0-99.9
0185	40186	Decoupling uplink switch	Initial value: 0,1: on 0: off
0186	40187	Delay before decoupling up	Initial value: 0.0, range: 0.0-99.9
0187	40188	Decoupling up time	Initial value: 0.0, range: 0.0-99.9
0188 ~ 0199	40189 ~ 40200	Reserve	
Weighing Parameters 1			
0200	40201	PWR-ON Zero	Initial value: 0,1: on 0: off
0201	40202	Zero Range	Initial value: 50, range: 1-99 Unit: %
0202	40203	Stable range	Initial value: 2, stability range (0~99. Optional) Unit:.
0203	40204	Stable time	Initial value: 0.3 seconds; Range: 0.1 to 9.9
0204	40205	TrZero Range	Initial value: 0, range: 0-9 Units:.
0205	40206	TrZero time	Initial value: 2.0; Range: 0.1~99.9s.
0206	40207	Result Check Filter	Initial value: 7, range: 0-9
0207	40208	Secondary filter switch	Initial value: 1,1: on 0: off
0208	40209	A/D Sample Rate	Initial value :1, 0:120; 1:240; 2:4800; 3:960
0209 ~ 0214	40210 ~ 40215	Reserved	
Weighing Parameters 2			
0215	40216	PreFill Zero Interval	Initial value: 0, range: 0-99
0216	40217	Result Check Mode	Initial value: 1 0: Judged stable value; 1: delay setting
0217	40218	There is a bucket	Initial value :0; Range: 0: Off; 1: On

		set weight hold switch	
0218	40219	Manual DISC To ACUM	Initial value :0; Range: 0: Off; 1: On
0219	40220	Manual discharge judge pinch bag switch	Initial value :0; Range: 0: Off; 1: On
0220	40221	Unload real time detection switch	Initial value :0; Range: 0: Off; 1: On
0221	40222	Gross/net weight packing pattern (no bucket)	Initial value: 1 (net weight) 0: Gross weight packing pattern without bucket scale 1: no bucket scale net weight packaging mode
0222	40223	Dynamic filter switch	Initial value :1; Range: 0: Off; 1: On The following parameters are valid only after the switch is on.
0223	40224	Filling Filter	Initial value: 4, range: 1 ~ 9
0224	40225	Result Check Filter	Initial value: 7, range: 1 ~ 9
0225	40226	Discharge Filter	Initial value: 3, range: 1 ~ 9
0226	40227	Adaptive grade	Initial value: 3; Range: 1~ 5
0227	40228	Adaptive switch	Initial value: 0; Range: 0 to 2 Select 0: Off; 1: double speed; 2: triple speed.
0228 ~ 0229	40229 ~ 40230	Reserve	
System Maintenance - scale body property parameters			
0230	40231	Scale structure	Initial value: 0; 0: with bucket, 1: without bucket, 2: loose material
0231	40232	Working mode	Initial value: 0 0: There are dou AB double scales, 1: there is A single bucket A scale, 2: there is a separate B scale, 3: Double bucket double pocket AB independent, 4: Double bucket double bag AB combination, 5: No bucket AB independent, 6: No bucket AB combination. 7: bulk material separate A scale, 8: bulk material separate B scale, 9: bulk material AB independent, 10: Bulk AB interlock. Write 0-4 with buckets, 5-6 without buckets, 7-10 for bulk material
0232	40233	AB target values are set separately	Initial value: Off; Off: AB share; On: AB target value can be set to different weights
0233	40234	Filling control method	Initial value: 1; 0: alone, 1: combined
0234	40235	Double scale loose bag pattern	Initial value: 0 0: Off; 1. At the same time loose bag normal mode, 2. Simultaneously loosen bag fast mode
0235-0236.	40236-40237	Single bucket maximum capacity	Weight value written range: ≤ maximum range
0237 ~ 0240	40238 ~ 40241	Reserved	
0241	40242	Manual Unlock Bag switch	Initial value :0; Range: 0: Off; 1: On
0242	40243	Allow loose bag switch when running	Initial value :0; Range: 0: Off; 1: On

0243	40244	Main engine discharge interlock switch	Initial value :0; Range: 0: Off; 1: On
0244	40245	Start clear number of times	Initial value :0, range :0 to 9.
0245	40246	Delay before clearing	Initial value :0s, ranging from 0.0 to 9.9s.
0246 ~ 0249	Reserve		
Peripheral parameters - Beat-bag parameters (1)			
0250	40251	Patting Bag Mode	Initial value: 0, there is a bucket can write 0/2; No bucket can write 0/1/2/3; 0: Turn off the patting bag function; 1: pat the bag only in the feed; 2: Pat the bag only after the set value; 3: Beat the bag after adding and setting the value.
0251	40252	Pat times in filling	Initial value: 0, range: 00 ~ 99
0252	40253	Pat bags after valuing	Initial value: 4, range: 00 ~ 99
0253	40254	Pat bag before delay	Initial value: 0.5 seconds, range: 0.0 ~ 99.9
0254	40255	Pat bag effective time	Initial value: 0.5 seconds, range: 0.0 ~ 99.9
0255	40256	Pat bag ineffective time	Initial value: 0.5 seconds, ranging from 0.0 to 99.9
0256	40257	Extra pat bag effective time	Initial value: 0.0 seconds, range: 0.0 ~ 99.9
0257-0258.	40258-40259.	Pat bag initial weight	Weight value written range: ≤ maximum range
Peripheral parameters - Coding parameters (2)			
0259	40260	Code switch	Initial value :0; Range: 0: Off; 1: On
0260	40261	Coding start delay	Initial value: 0.5 seconds, range: 0.0 ~ 99.9
0261	40262	Coding Duration Timer	Initial value: 0.5 seconds, range: 0.0 ~ 99.9
0262	40263	Not Allow Fill/Discharge When Coding	Initial value: 0 0: Allow to start unloading output or charging output during the coding process; 1: the unloading output or charging output is not allowed to start during the coding process
Peripheral parameters - double bag with bucket, no bucket mode conveyor parameters (3)			
0263	40264	Conveyor switch	Range :0-3; Initial value: 0 0: Close the conveyor Level 1:1 conveyor 2:2 stage conveyor 3:3 Stage conveyor
0264	40265	Conveyor start-up delay	Initial value: 0.5 seconds, range 0-99.9
0265	40266	Conveyor run time	Initial value: 4.0 seconds, range 0-99.9
0266	40267	B Delayed Before Starting Next Filling	Initial value: 2.0 seconds, range 0-9.9
Peripheral Parameters - Print Parameters (4)			
0267	40268	Automatic print switch	Initial value: 0,1: on 0: off
0268	40269	Print Format	Initial value: 0 0:24 column print 1:32 column print
0269	40270	Print language	Initial value: 0,1: English 0: Chinese
0270	40271	Print the number of	Initial value: 3, 0-9

		lines of paper run	
Peripheral Parameters - Sewing machine parameters (5)			
0271	40272	Sewing machine start delay	0.0~99.9s Default: 0.5
0272	40273	Sewing machine output valid time	0.0~99.9s Default: 0.5
0273	40274	Cutter output valid time	0.0 to 99.9s The default value is 0.5
0274	40275	Delay before stopping the sewing machine	0.0~99.9s Default: 0.5
Peripheral parameters - Discharge vibration parameters (6)			
0275	40276	DISC Shaking ON/OFF	0:OFF; 1: DISC Shaking Independent ; 2: DISC Door Shaking , 0 by default
0276	40277	Discharge valid time	0.0~9.9, default 0.5
0277	40278	Discharge patting valid time	0.0 to 9.9, default 0.5
0278	40279	Discharge patting invalid time	0.0 to 9.9, default 0.5
0279	40280	Discharge patting times	0 to 99, default 10
Peripheral parameters - Timeout alarm parameters (7)			
0280	40281	Fill, DICS overtime ON/OFF	0 ~1 Default 0
0281	40282	A coarse filling overtimer	0.0~99.9s default 5.0
0282	40283	A medium filling overtimer	0.0 to 99.9s defaults to 5.0
0283	40284	A fine filling overtimer	0.0~99.9s default 5.0
0284	40285	A DISC overtimer	0.0~99.9s default 5.0
0285	40286	B coarse filling overtimer	0.0~99.9s default 5.0
0286	40287	B medium filling overtimer	0.0 to 99.9s defaults to 5.0
0287	40288	B fine filling overtimer	0.0~99.9s default 5.0
0288	40289	B DISC overtimer	0.0~99.9s Default 5.0
0289	40290	Cutter Start Delay Timer	0.0~99.9s default is 0.5
0290	40291	Sewing ON/OFF	Initial value: 0; 0: off, 1: on
0291	40292	Sewing de-shaking timer	Initial value: 0.3, range: 0-99.9s
0292	40293	Tractor switch	Initial value: 0; 0: off, 1: on
0293	40294	Handle after loading timeout	Initial value: 2; Range: 0 to 2
0294-0295	40295-40296	Feed timeout lower limit	Initial value: 0; Range: 0 ~ Max range;
0296	40297	Disposal after discharge timeout	Initial value: 2; Range: 0 to 2;
0297	40298	Conveyor 2/3 maximum running time	Initial value: 30.0, range: 0-99.9s
0298 ~ 0299	40299 ~ 40300	Reserved	
Communication Settings - Serial 1 Parameter Settings (1)			
0300	40301	ID number	Scale number.Default: 1;range: 1-99
0301	40302	Communication	Initial value: Modbus-RTU

		method	0: Modbus-RTU; 1: print 2: Continuous mode 3: Re-ContA 4: Re-ContB
0302	40303	Baud rate	Range: 0: 9600; 1: 19,200; 2: 38,400; 3: 57600; 4:115200 Default: 2 (38400)
0303	40304	Data format	Range: 0: 8-E-1; 1: 8-N-1; 2: 7-E-1; 3: 7-N-1) Default: 0 (8-E-1)
0304	40305	High-low words	MODBUS double word register storing order. Range: 0-1 (0: AB-CD; 1: CD-AB) Default: 0 (AB-CD)
Communication Settings - Serial Port 2 Parameter Settings (2)			
0305	40306	ID	Scale number. Default:1;range:1-99
0306	40307	Communication method	Initial value: Modbus-RTU 0: Modbus-RTU; 1: print 2: Continuous mode 3: Re-ContA 4: Re-ContB
0307	40308	Baud rate	Range: 0: 9600; 1: 19,200; 2: 38,400; 3: 57600; 4:115200 Default: 2 (38400)
0308	40309	Data format	Range: 0: 8-E-1; 1: 8-N-1; 2: 7-E-1; 3: 7-N-1 Default: 0 (8-E-1)
0309	40310	High-low words	MODBUS double word register storing order. Range: 0-1 (0: AB-CD; 1: CD-AB) Default: 0 (AB-CD)
Print cumulative			
0310	40311	Print total ACUM	Read as 0; Write 1 to print total cumulative
0311	40312	Print recipe Accumulations	Read to 0 Write 0 to print the current recipe cumulative Write 1-40 to print the corresponding recipe cumulative Write 41 to print all recipe accumulations
0312	40313	Print user accumulations	Read as 0 Write 100 and print the current user cumulative Write 0-9 and print the corresponding user cumulative Write 101 and print all users cumulative
0313-0319	Reserved		
factory data reset			
0320	40321	factory data reset	8800 Restore all parameters to factory Settings (including scale parameters) 8801 Restore calibration 8802 Restore weighing parameters 8803 Restore recipe parameters 8804 Restore IO definition 8805 Perform backup 8806 Perform restore Read return 0
Switch quantity test parameter entry			
0321	40322	Start/end switch quantity test	Write 1 Start the switch quantity test. Write 0 to exit the switch quantity test state. Write to stop state Read: Returns the status of the current volume

			test switch
0322	40323	Enter the switch quantity test	Write: Write is not allowed Read: Input from low to high corresponding to ports IN1 to 12, where 1 indicates valid input and 0 indicates invalid input.
0323-0324	40324-40325	Output switching quantity test	Write: The test switch can be written when the switch is open, and the corresponding ports OUT1~16 output from low to high respectively. 1 indicates that the output is valid, 0 indicates that the output is invalid. Read: Returns the status of the current output switch quantity port, corresponding to the output of ports OUT1~16 from low to high, 1 indicates that the output is valid, 0 indicates that the output is invalid.
0325-0349	Reserve		
Switch quantity Custom parameter entry			
0350	40351	Switch quantity input port 1 Defined	Write: Write the function code corresponding to the switch quantity content. If IN is defined as run, 1 should be written IN the corresponding register in Read: Returns the current switch quantity custom status(Refer to the definition of switch quantity in Section 4.8 for the meaning of function code)
0351	40352	Switch quantity input port 2 Defined	
0352	40353	Switch quantity input port 3 Defined	
0353	40354	Switch quantity input port 4 Defined	
0354	40355	Switch quantity input port 5 Defined	
0355	40356	Switch quantity input port 6 Defined	
0356	40357	Switch quantity input port 7 Defined	
0357	40358	Switch quantity input port 8 Defined	
0358	40359	Switch quantity input port 9 Defined	
0359	40360	Switch quantity input port 10 Defined	
0360	40361	Switch quantity input port 11 Defined	
0361	40362	Switch quantity input port 12 defined	
0362	40363	Switching quantity Output port 1 Defined	Write: Write the function code corresponding to the switch quantity content. If OUT is defined as run, 1 should be written in the corresponding register of OUT Read: Returns the current switch quantity custom status(Refer to the definition of switch quantity in Section 3.9 for the meaning of function code)
0363	40364	Switch quantity output port 2 Defined	
0364	40365	Switching quantity output port 3 Defined	
0365	40366	Switching quantity output port 4 Defined	
0366	40367	Switch quantity Output port 5 Defined	
0367	40368	Switch quantity output port 6 defined	
0368	40369	Switch quantity Output port 7 Defined	
0369	40370	Switching quantity Output port 8 Defined	
0370	40371	Switching quantity Output port 9 Defined	
0371	40372	Switch quantity output port 10 Defined	
0372	40373	Switch quantity output port 11 Defined	
0373	40374	Switch quantity output port 12 Defined	
0374	40375	Switching quantity Output port 13 defined	
0375	40376	Switch quantity Output port 14 defined	
0376	40377	Switch quantity Output port 15 defined	
0377	40378	Switch quantity Output port 16 defined	
0378-0399	Reserve		
40 recipe target value parameter items (readable and writable)			
0400-0401	40401-40402	Recipe 1 Target value	Initial value: 0
0402-0403	40403-40404	Recipe 2 Target value	Initial value: 0
... Sequential read/write 3-39 target values	
0478-0479	40479-40480	Recipe 40 target value	Initial value: 0

0480-0499	Reserved		
40 Formula A scale Target value parameter items (readable and writable)			
0500-0501	40501-40502	Formula 1A target value	Initial value: 0
0502-0503	40503-40504	Formula 2A target value	Initial value: 0
...		... Read/write 3A-39A target values sequentially	
0578-0579	40579-40580	Recipe 40A target value	Initial value: 0
0580-0599	Reserved		
40 Formula B scale target value parameter items (readable and writable)			
0600-0601	40601-40602	Formula 1B Target value	Initial value: 0
0602-0603	40603-40604	Formula 2B target value	Initial value: 0
...		... Sequential read/write 3B-39B target values	
0678-0679	40679-40680	Formula 40B target value	Initial value: 0
0680-0699	Reserve		
40 recipe cumulative weight parameter items			
0700-0701	40701-40702	Recipe 1 Add up the weight	
0702-0703	40703-40704	Recipe 2 Add up the weight	
...		... Sequential readout user 3-8 cumulative weight data	
0778-0779	40779-40780	Recipe 40 Cumulative weight	
0780-0799	Reserve		
40 recipe cumulative packet number parameter entries			
0800-0801	40801-40802	Recipe 1 Cumulative packet number (write 0 to clear the cumulative weight and packet number of this recipe)	
0802-0803	40803-40804	Recipe 2 Cumulative packet number (write 0 to clear the cumulative weight and packet number of this recipe)	
...	...	Read the user 3-8 cumulative packet count data sequentially	
0878-0879	40879-40880	Recipe 40 Cumulative packet number (write 0 to clear the cumulative weight and packet number of this recipe)	
0880-0899	Reserve		
10 users cumulative weight			
0900-0901	40901-40902	User 0 Accumulated weight (write 0 to clear accumulated weight and number of packets for this user)	
0902-0903	40903-40904	User 1 Cumulative weight (write 0 to clear this user cumulative weight and number of packets)	
0904-0905	40905-40906	User 2 Cumulative weight (write 0 to clear this user cumulative weight and number of packets)	
...		Sequential readout user 3-8 cumulative weight data	
0918-0919	40919-40920	Accumulated weight of user 9 (Write 0 to clear the accumulated weight and number of packets of the user)	
0920-0949	Reserved		
10 user accumulative times			
0950-0951	40951-40952	User accumulated count 0(Write 0 to clear accumulated weight and number of packets for this user)	
0952-0953	40953-40954	User accumulated count 1(write 0 to clear accumulated weight and number of packets for this user)	
0954-0955	40955-40956	User accumulated count 2(write 0 to clear accumulated weight and number of packets for this user)	
...		Read the user's cumulative count data 3-8 in sequence	
0968-0969	40969-40970	User accumulated count 9(Write 0 to clear accumulated weight and number of packets for this user)	
0970-0999	40971-41000	Reserve	
Motor Parameters			
1000	41001	Feeding mode: 0: Pneumatic (default); 1: Electric	
1001	41002	Generator number: 0 (default); Range: 0-4 Optional	
1002	41003	Filling stepper motor frequency of	Range:1-50000; initial

		scale A	value: 12000Hz
1003-1004	41004-41005	A filling close to Motor Steps For Fi-Flow	Range: 1-60000; initial value: 1800
1005-1006	41006-41007	A filling close to Motor Steps For Me -Flow	Range: 1-60000; initial value: 4300
1007-1008	41008-41009	A filling close to Motor Steps For Co -Flow	Range: 1-60000; initial value: 7750
1009	41010	The motor rotation direction signal of scale A fill gate	Range:0:OFF:Gate Open Direction;1: ON:Gate Open Direction,; initial value:0
1010	41011	Filling stepper motor frequency of scale B	Range:1-50000; initial value: 12000Hz
1011-1012	41012-41013	B filling close to Motor Steps For Fi-Flow	Range: 1-60000; initial value: 1800
1013-1014	41014-41015	B filling close to Motor Steps For Me -Flow	Range: 1-60000; initial value: 4300
1015-1016	41016-41017	B filling close to Motor Steps For Co -Flow	Range: 1-60000; initial value: 7750
1017	41018	The motor rotation direction signal of scale B fill gate	Range:0:OFF:Gate Open Direction;1: ON:Gate Open Direction,; initial value:0
1018	41019	Scale A filling motor start frequency	Range:1-50000; initial value: 2000Hz
1019	41020	Scale A filling motor acceleration time	Range:0~9999(ms) ; initial value:200ms
1020	41021	Scale A filling motor deceleration time	Range:0~9999(ms) ; initial value: 50ms
1021	41022	Scale B filling motor start frequency	Range:1-50000Hz ; initial value: 2000Hz
1022	41023	Scale B filling motor acceleration time	Range:0~9999(ms); initial value:200ms
1023	41024	Scale B filling motor deceleration time	Range:0~9999(ms); initial value:50ms
1024	41025	The running time of scale A filling gate opens to Coarse Flow. (Normal motors)	Range:0~99.9(s); initial value: 0.8s
1025	41026	The running time of scale A filling gate opens to Medium Flow.	Range:0~99.9(s); initial value: 0.4s
1026	41027	The running time of scale A filling gate opens to Fine Flow.	Range:0~99.9(s); initial value: 0.2s
1027	41028	The running time of scale B filling gate opens to Coarse Flow.	Range:0~9999(ms);initial value: 50ms
1028	41029	The running time of scale B filling gate opens to Medium Flow.	Range:0~99.9(s); initial value: 0.8s
1029	41030	The running time of scale B filling gate opens to Fine Flow.	Range:0~99.9(s); initial value: 0.4s
1030	41031	Filling gate closed timeout	Range:0~99.9(s); initial value: 0.2s
1031	41032	Motor filling gate opened anti logically	
1032	41033	Bag locked mode	0:Air Drived;1:Step Motor;2:Normal Motor(Two Pos. Signal); 3: Normal Motor(One Pos. Signal);
1033	41034	Bag locked frequency of scale A (Stepper motor)	Range:1-50000Hz; initial value:30000Hz
1034	41035	Bag unlocked frequency of scale A	Range:1-50000Hz; initial value: 20000Hz

1035-1036	41036-41037	Pulses quantity required that state of bag unlocked state turns to bag locked state of scale A motor	Range:1~60000; initial value: 12000
1037	41038	The motor rotation direction signal of scale A bag locked	Initial value:0; Optional: 0: OFF:If Clamper Open Direction: 1: ON:If Clamper Open Direction: 8
1038	41039	Motor frequency of scale B bag locked	Range:1-50000Hz;initial value: 30000Hz
1039	41040	Motor frequency scale B bag unlocked	Range:1-50000Hz; initial value: 20000Hz
1040-1041	41041-41042	Pulses quantity required that state of bag unlocked turns to bag locked of scale B motor	Range:1~60000; initial value: 12000
1042	41043	The motor rotation direction signal of scale B bag locked	Initial value: 0; Optional: 0: OFF:If Clamper Open Direction: 1: ON:If Clamper Open Direction:
1043	41044	Scale A bag locked motor start frequency	Range:1-50000Hz;initial value: 2000Hz
1044	41045	Scale A bag locked motor acceleration time	Range:0~9999(ms); initial value: 200ms
1045	41046	Scale A bag locked motor deceleration time	Range:0~9999(ms); initial value: 50ms
1046	41047	Scale B bag locked motor start frequency	Range:1-50000Hz; initial value: 2000Hz
1047	41048	Scale B bag locked motor acceleration time	Range:0~9999(ms); initial value: 200ms
1048	41049	Scale B bag locked motor deceleration time	Range:0~9999(ms); initial value: 50ms
1049	41050	Bag unlocked time (Normal motor)	Range:0~99.9(s); initial value: 0.5s
1050	41051	Bag unlocked timeout	Range:0~99.9(s); initial value: 3.0s
1051	41052	Bag locked timeout	Range:0~99.9(s); initial value: 3.0s
1052	41053	Clamper position signal type	Initial value: 0; Optional: 0: ON:If Closed;1:OFF:If Closed;
1053	41054	Discharge mode	0: Air Dived; 1: Step Motor; 2: Normal Motor(One Pos. Signal) ; 3: Normal Motor(Two Pos. Signal); 4:Normal Motor Rotating
1054	41055	Scale A discharge gate opened motor frequency	Range:1-50000Hz;initial value: 30000Hz
1055	41056	Scale A discharge gate closed motor frequency	Range:1-50000Hz;initial value: 20000Hz
1056-1057	41057-41058	Pulses quantity required that state of closed turns to opened of scale A motor	Range:1~60000; initial value: 12000
1058	41059	The signal of motor rotation direction of scale A discharge gate opened	initial value: 0; Optional: 0: ON:If Closed; 1:OFF:If Closed;
1059	41060	The motor frequency of scale B discharge gate opened	Range:1-50000Hz; initial value: 30000Hz

1060	41061	The motor frequency of scale B discharge gate closed	Range:1-50000Hz; initial value: 20000Hz
1061-1062	41062-41063	Pulses quantity required that state of closed turns to opened of scale B motor	Range:1~60000; initial value: 12000
1063	41064	The signal of motor rotation direction of scale B discharge gate opened	Initial value: 0; Optional: 0: ON:If Closed; 1:OFF:If Closed;
1064	41065	Scale A discharge motor started frequency	Range:1-50000Hz; initial value: 2000Hz
1065	41066	Scale A discharge motor acceleration time	Range:0~9999(ms); initial value: 200ms
1066	41067	Scale A discharge motor deceleration time	Range:0~9999(ms); initial value: 50ms
1067	41068	Scale B discharge motor started frequency	Range:1-50000Hz; initial value: 2000Hz
1068	41069	Scale B discharge motor acceleration time	Range:0~9999(ms); initial value: 200ms
1069	41070	Scale B discharge motor deceleration time	Range:0~9999(ms); initial value: 50ms
1070	41071	Scale A discharge motor gate opened signal output time (Normal motors)	Range:0.0~99.9(s);initial value: 1.0s
1071	41072	Scale B discharge motor gate opened signal output time	Range:0.0~99.9(s);initial value: 1.0s
1072	41073	Discharge gate closed timeout	Range:0.0~99.9(s);initial value: 3.0s
1073	41074	Discharge gate opened timeout	Range:0.0~99.9(s);initial value: 3.0s
1074	41075	Motor discharge ON/OFF anti logically	
1075	41076	Discharge limit digit real-time detection ON/OFF	Range:OFF,ON.initial value: OFF
1076	41077	Motor group no. of present recipe	Initial value: 0;Range:0~4
Peripheral Parameters - Auxiliary pulse parameters (8)			
1079	41080	Auxiliary pulse switch	Initial value: 0,1: on 0: off
1080	41081	Auxiliary Pulse 1 Perform total time	0.0~999.9s Default 0(if 0, execute all the time)
1081	41082	Auxiliary Pulse 1 Effective time	0.0~999.9s The default is 10.0s
1082	41083	Auxiliary Pulse 1 Ineffective time	0.0~999.9s The default is 10.0s
1083	41084	Auxiliary Pulse 2 Perform total time	0.0~ 999.9s Default 0(if 0, execute all the time)
1084	41085	Auxiliary pulse 2 Effective time	0.0~999.9s 10.0s by default
1085	41086	Auxiliary pulse 2 Ineffective time	0.0~999.9s The default is 10.0s
1086	41087	Auxiliary pulse 3 Perform total time	0.0~999.9 min Default 0(if 0, execute all the time)
1087	41088	Auxiliary pulse 3 Effective time	0.0 to 999.9 min The default is 10.0 min
1088	41089	Auxiliary pulse 3 Ineffective time	0.0 to 999.9 min The default is 10.0 min
1089	41090	Auxiliary pulse 4 Perform total time	0.0~999.9 min Default 0(if 0, execute all the time)
1090	41091	Auxiliary pulse 4 Effective time	0.0~999.9 min Default 10.0
1091	41092	Auxiliary pulse 4 Ineffective time	0.0~999.9 min Default 10.0

Communication Settings - Network Port parameters			
1100	41101	High-low words	Initial value 0. Range: 0: AB-CD; 1: CD-AB
1101	41102	Port number	Initial value :502; Range 1 to 65535
1102~1105	41103~41106	IP1~IP4	Initial value:192.168.101.246,range 0.0.0.0~255.255.255.255
1106~1111	41107~41112	MAC Address	MAC1~ MAC6, Only read
User Logic Program 1			
1150	41151	Type	Initial value: 0; Range 0 to 5.
			0: Off
			1: Delay switch on
			2: Delay disconnect
			3: Delay connected and delay disconnected
			4: Invalid - Valid jump edge trigger
5: Valid - Invalid jump edge trigger			
1151	41152	Trigger Signal	Initial value: 0; Range: 0 to 64. Optional custom trigger input port, fixed switch input port 1~12, switch output definition, weight value trigger
1152	41153	Trigger the input signal port	Initial value: 0; Range 0 to 12. Select the switch quantity input port 0 to 12 corresponding to the function signal, and the input port -0 means that the function is not defined.
1153	41154	Output signal port	Initial value: 0; Range 0 to 16. Select the switch quantity output port 0 to 16 corresponding to the function signal, and the output port -0 means that the function is not defined.
1154	41155	Delay turn-on time	Initial value: 0; Range: 0 to 99.9s.
1155	41156	Delayed disconnect time	Initial value: 0; Range: 0 to 99.9s.
1156	41157	Signal output valid time	Initial value: 0; Range: 0 to 99.9s.
1157-1158.	41158 ~ 41159	Threshold weight	Initial value: 0; Range: 0~ maximum range
1159 ~ 1169	41160 ~ 41170	Reserve	
User Logic Program 2			
1170	41171	Type	Initial value: 0; Range 0 to 5.
			0: Off
			1: Delay switch on
			2: Delay disconnect
			3: Delay connected and delay disconnected
			4: Invalid - Valid jump edge trigger
5: Valid - Invalid jump edge trigger			
1171	41172	Trigger Signal	Initial value: 0; Range: 0 to 64. Optional custom trigger input port, fixed switch quantity input port 1~12, switch quantity output definition, weight value trigger
1172	41173	Trigger input signal port	Initial value: 0; Range 0 to 12. Select the switch quantity input port 0 to 12 corresponding to the function signal, and the input port -0 means that the function is not defined.
1173	41174	Output signal port	Initial value: 0; Range 0 to 16. Select the switch quantity output port 0 to 16 corresponding to the function signal, and the

			output port -0 means that the function is not defined.
1174	41175	Delay turn-on time	Initial value: 0; Range: 0 to 99.9s.
1175	41176	Delayed disconnect time	Initial value: 0; Range: 0 to 99.9s.
1176	41177	Signal output valid time	Initial value: 0; Range: 0 to 99.9s.
1177-1178.	41178 ~ 41179	Threshold weight	Initial value: 0; Range: 0~ maximum range
1179 ~ 1189	41180 ~ 41190	Reserve	
User Logic Program 3			
1190	41191	Type	Initial value: 0; Range 0 to 5.
			0: Off
			1: Delay switch on
			2: Delay disconnect
			3: Delay connected and delay disconnected
			4: Invalid - Valid jump edge trigger
5: Valid - Invalid jump edge trigger			
1191	41192	Trigger Signal	Initial value: 0; Range: 0 to 64. Optional custom trigger input port, fixed switch quantity input port 1~12, switch quantity output definition, weight value trigger
1192	41193	Trigger the input signal port	Initial value: 0; Range 0 to 12. Select the switch quantity input port 0 to 12 corresponding to the function signal, and the input port -0 means that the function is not defined.
1193	41194	Output signal port	Initial value: 0; Range 0 to 16. Select the switch quantity output port 0 to 16 corresponding to the function signal, and the output port -0 means that the function is not defined.
1194	41195	Delay turn-on time	Initial value: 0; Range: 0 to 99.9s.
1195	41196	Delayed disconnect time	Initial value: 0; Range: 0 to 99.9s.
1196	41197	Signal output valid time	Initial value: 0; Range: 0 to 99.9s.
1197-1198.	41198 ~ 41199	Threshold weight	Initial value: 0; Range: 0~ maximum range
1199 ~ 1209	41200 ~ 41210	Reserve	
User Logic Program 4			
1210	41211	Type	Initial value: 0; Range 0 to 5.
			0: Off
			1: Delay switch on
			2: Delay disconnect
			3: delay connecting and delay disconnecting
			4: Invalid - Valid jump edge trigger
5: Valid - Invalid jump edge trigger			
1211	41212	Trigger Signal	Initial value: 0; Range: 0 to 64. Optional custom trigger input port, fixed switch quantity input port 1~12, switch quantity output definition, weight value trigger
1212	41213	Trigger input signal port	Initial value: 0; Range 0 to 12.

			Select the switch quantity input port 0 to 12 corresponding to the function signal, and the input port -0 means that the function is not defined.
1213	41214	Output signal port	Initial value: 0; Range 0 to 16. Select the switch quantity output port 0 to 16 corresponding to the function signal, and the output port -0 means that the function is not defined.
1214	41215	Delay turn-on time	Initial value: 0; Range: 0 to 99.9s.
1215	41216	Delayed disconnect time	Initial value: 0; Range: 0 to 99.9s.
1216	41217	Signal output valid time	Initial value: 0; Range: 0 to 99.9s.
1217-1218.	41218 ~ 41219	Threshold weight	Initial value: 0; Range: 0~ maximum range
1219 ~ 1229	41220 ~ 41230	Reserve	
User Logic Program5			
1230	41231	Type	Initial value: 0; Range 0 to 5.
			0: Off
			1: Delay switch on
			2: Delay disconnect
			3: Delay connected and delay disconnected
			4: Invalid - Valid jump edge trigger
5: Valid - Invalid jump edge trigger			
1231	41232	Trigger Signal	Initial value: 0; Range: 0 to 64. Optional custom trigger input port, fixed switch quantity input port 1~12, switch quantity output definition, weight value trigger
1232	41233	Trigger input signal port	Initial value: 0; Range 0 to 12. Select the switch quantity input port 0 to 12 corresponding to the function signal, and the input port -0 means that the function is not defined.
1233	41234	Output signal port	Initial value: 0; Range 0 to 16. Select the switch quantity output port 0 to 16 corresponding to the function signal, and the output port -0 means that the function is not defined
1234	41235	Delay turn-on time	Initial value: 0; Range: 0 to 99.9s.
1235	41236	Delayed disconnect time	Initial value: 0; Range: 0 to 99.9s.
1236	41237	Signal output valid time	Initial value: 0; Range: 0 to 99.9s.
1237-1238	41238~41239	Threshold weight	Initial value: 0; Range: 0~ maximum range
1239~1249	41240~41250	Reserve	
User Logic Program 6			
1250	41251	Type	Initial value: 0; Range 0 to 5.
			0: Off
			1: Delay switch on
			2: Delay disconnect
			3: Delay connected and delay disconnected
			4: Invalid - Valid jump edge trigger
5: Valid - Invalid jump edge trigger			
1251	41252	Trigger Signal	Initial value: 0; Range: 0 to 64.

			Optional custom trigger input port, fixed switch quantity input port 1~12, switch quantity output definition, weight value trigger
1252	41253	Trigger input signal port	Initial value: 0; Range 0 to 12. Select the switch quantity input port 0 to 12 corresponding to the function signal, and the input port -0 means that the function is not defined
1253	41254	Output signal port	Initial value: 0; Range 0 to 16. Select the switch quantity output port 0 to 16 corresponding to the function signal, and the output port -0 means that the function is not defined
1254	41255	Delay turn-on time	Initial value: 0; Range: 0 to 99.9s.
1255	41256	Delayed disconnect time	Initial value: 0; Range: 0 to 99.9s.
1256	41257	Signal output valid time	Initial value: 0; Range: 0 to 99.9s.
1257-1258	41258-41259	Logical threshold weight	Initial value: 0; Range: 0~ maximum range
1259~1299	41260~41300	Reserve	
1300	41301	A feed motor power back to zero frequency (initial value: 2000; Range: 1~50000)	
1301	41302	B feed motor power back to zero frequency (initial value: 2000; Range: 1~50000)	
1302	41303	A clip loose bag motor power-on back to zero frequency (initial value: 2000; Range: 1~50000)	
1303	41304	B Clip loose bag motor power-on back to zero frequency (initial value: 2000; Range: 1~50000)	
1304	41305	A discharge motor power back to zero frequency (initial value: 2000; Range: 1~50000)	
1305	41306	B discharge motor power back to zero frequency (initial value: 2000; Range: 1~50000)	
1306	41307	No position signal for fill gate	Range:OFF,ON, Initial value: OFF
1307	41308	No position signal for clamper	Range:OFF,ON, Initial value: OFF
1308	41309	No position signal for DISC gate	Range:OFF,ON, Initial value: OFF
1309-1310	1310-1311	Scale A filler:Motor steps for closed	Range:1~60000; Initial value: 100;
1311-1312	1312-1313	Scale B filler:Motor steps for closed	Range:1~60000; Initial value: 100;
1313-1314	1314-1315	Scale A clamper: Steps for clamper open	Range:1~60000; Initial value: 100;
1315-1316	1316-1317	Scale B filler: Steps for clamper open	Range:1~60000; Initial value: 100;
1317-1318	1318-1319	Scale A DISC: Discharge Steps for closed	Range:1~60000; Initial value: 100;
1319-1320	1320-1321	Scale B DISC: Discharge Steps for closed	Range:1~60000; Initial value: 100;
1321 ~ 1999	41322 ~ 42000	Reserve	
Statistic parameters			
2000-2001	42001-42002	Total cumulative value 6 places higher	
2002-2003	42003-42004	Total cumulative value 9 places lower	
2004-2005	42005-42006	Total cumulative runs	
2006-2007	42007-42008	The current recipe cumulative value is 6 places higher	

2008-2009	42009-42010	Current recipe cumulative value is 9 places lower		
2010-2011	42011-42012	Current recipe cumulative times		
2012-2013	42013-42014	The current user cumulative value is 6 digits higher		
2014-2015	42015-42016	The current user accumulative value is 9 digits lower		
2016-2017	42017-42018	Cumulative times of the current user		
2018-2019	42019-42020	Recipe 1 Cumulative value 6 places higher		
2020-2021	42021-42022	Recipe 1 Cumulative value is 9 places lower		
2022-2023	42023-42024	Recipe 1 Add up the reps		
... (Read recipe cumulative value sequentially)				
2252-2253	42253-42254	Recipe 40 Cumulative value 6 places higher		
2254-2255	42255-42256	The cumulative value of recipe 40 is 9 places lower		
2256-2257	42257-42258	Recipe 40 Cumulative times		
2258-2259	42259-42260	User 1 Cumulative value higher by 6 digits		
2260-2261	42261-42262	User 1 Cumulative value is 9 digits lower		
2262-2263	42263-42264	User 1 Cumulative count		
... (Read user cumulative values sequentially)				
2312-2313	42313-42314	The accumulated value of user 10 is six digits higher		
2314-2315	42315-42316	User 10 Cumulative value low by 9 digits		
2316-2317	42317-42318	User 10 Cumulative times		
2318	42319	Clear Total cumulative	Write 1 Clear total cumulative.	
2319	42320	Clear recipe Accumulations	Write 1-20 to clear the corresponding cumulative data; Write 100 to clear the current recipe accumulations; Write 101 to clear all recipe accumulations.	
2320	42321	Clear user accumulations	Read as 0. Write 0-9 to clear the corresponding user accumulative; Write 100 to clear the current user cumulative; Write 101 to clear all user accumulations.	
2321 ~ 29999	42322 ~ 43000	Reserve		
3000-3001	43001-43002	Current traffic		
3002	43003	Flow window length (1~6)		
3003	43004	Flow unit; 0: g/h1 : kg/h2 : t/h 3: lb/h		
3004	43005	Flow decimal point (0 to 4)		
3005-3006	43006-43007	6 digits higher in total shipments (0 to 99,999)		
3007-3008	43008-43009	9 digits lower in total shipped (0~99999999)		
3009-3010	43010-43011	Cumulative times of collection and delivery (0~99999999)		
3011-3012	43012-43013	Collect and ship cumulative high 6 digits (0~ 99,999)		
3013-3014	43014-43015	Collect and ship cumulative low 9 digits (0~99999999)		
3015-3016	43016-43017	Total cumulative times of the system (0~99999999)		
3017-3018	43018-43019	System total cumulative high 6 digits (0 to 99,999)		
3019-3020	43020-43021	System total cumulative low 9 digits (0 to 99999999)		
3021 ~ 3999	Reserve			
16-bit status message address (to use for matching touch screen)				
4000-4001	44001-44002	A Scale the current weight	The weight display of scale A on the meter	
4002	44003	A Scale current weight status	Bit	Instructions
			D0	Weight unstable: 0; Stable: 1
			D1	Non-zero: 0; Zero: 1
			D2	The symbol +/- that currently displays weight

				Plus sign: 0; Negative sign: 1
			D3	Overflow
			D4	Weight positive overflow
			D5	Weight negative overflow
			D6	Sensor positive overflow
			D7	Sensor negative overflow
			D8	Millivolts stable: 1; Unstable: 0
			D9~15	Reserved
4003	Reserve			
4004-4005	44005-44006	B Scale the current weight	The weight display on the B scale on the meter	
4006	44007	B Scale current weight status	Refer to the current weight status of Scale A	
4007	44008	Reserve		
4008	44009	AB Scale Common Control Status 1	D0	0: Stop; 1: Run.
			D1	Alarm
			D2	Batch completed
			D3	Pocket clip
			D4	Loading position
			D5	Blanking position
			D6	For feeding
			D7	Underfeed
			D8	Patter bag
			D9	Conveyor output (no bucket)
			D10	Coding output
			D11	Seamer output
			D12	Tangential output
			D13	Auxiliary Pulse 1
			D14	Auxiliary Pulse 2
D15	Auxiliary Pulse 3			
4009	44010	AB Scale Common Control Status 2	D0	Auxiliary Pulse 4
			D1	Relay output 1
			D2	Relay Output 2
			D3	Relay Output 3
			D4	Relay output 4
			D5	Relay output 5
			D6	Relay output 6
			D7	Slow Stop
			D8	A bracket up
			D9	B Bracket up
			D10	Last scale
			D11~15	Reserved
4010	44011	A Scale current control status 1	D0	A Before adding
			D1	A Quick Add
			D2	A Canada
			D3	A Slow Add
			D4	A fixed value
			D5	A Unloading
			D6	A zero zone
			D7	A Out-of-tolerance
			D8	A underbalance
			D9	A Qualified

			D10	A Overunderbalance pause
			D11	A scale clip bag (no bucket)
			D12	A scale bat bag
			D13	A Code output
			D14	Gross Net weight Status Gross weight: 0; Net weight: 1
			D15	A Discharge vibration
4011	44012	A balance current control state 2	D0	A Weigh up
			D1	A Unloading complete
			D2~15	Reserved
4012	44013	B Scale current control status 1	Same as the current control state of scale A 1	
4013	44014	B Scale current control status 2	Same as balance A current control state 2	
4014-4015	44015-44016	Total cumulative weight (0 to 999,999,999)		
4016-4017	44017-44018	Total cumulative packet count (0 to 999,999,999)		
4018-4019	44019-44020	Current recipe Cumulative weight (0~999999999)		
4020-4021	44021-44022	Current recipe cumulative packet number (0 to 999999999)		
4022-4023	44023-44024	User accumulated weight (0~999999999)		
4024-4025	44025-44026	User total number of packets (0 to 999999999)		
4026-4027	44027-44028	A Weight on the previous scale		
4028-4029	44029-44030	B Weigh on the previous scale		
4030	44031	A Scale alarm information	<ul style="list-style-type: none"> 0. No alarm 1. Formula setting is not reasonable, can not start; 2. Single bucket maximum capacity is 0, can not start; 3. The weight exceeds the clearance range when clearing; 4. The weight is unstable when clearing; 5. Over and under alarm; 6. The target value of a single scale cannot be set to 0. The maximum range is too large. 7. The single scale target value is greater than the maximum capacity of a single bucket; 8. Weight overflow or sensor overflow when starting; 9. Discharge door out of limit 10.No pinch bag (manual unloading judgment pinch bag opened, manual unloading unpinch bag will prompt no pinch bag, no pinch bag in operation) 11.Zero clearance during operation 12.Clear during operation out of range 13.Running clear is unstable 14. Motor parameter setting is not reasonable (ordinary motor) 15. Reservation 	
4031	44032	B Scale alarm information		
4032-4033	44033-44034	Regular alarm information	<ul style="list-style-type: none"> 0- No alarm; 1-Batch times completed; 2-A over and underbalance suspended; 3-B hyperunderbalance pause; 4-A balance motor charging door closed timeout alarm 5-B balance motor charging door closing timeout alarm 6-A balance bag timeout alarm 	

			<p>7- B balance bag timeout alarm 8- A balance loose bag timeout alarm 9- B balance loose bag timeout alarm 10- A balance unloading and closing time alarm 11- B balance unloading and closing time alarm 12- A balance unloading door timeout alarm 13- B balance unloading door timeout alarm 14- A balance charging door is not closed in place alarm 15- B scale charging door is not closed in place to alarm 16- A balance discharge door is not closed in place alarm 17- B scale discharge door is not closed in place to alarm 18- Motherboard and additional version communication abnormal alarm 19- A scale quickly add timeout alarm 20- Scale B fast overtime alarm 21- Scale A add timeout alarm 22- B balance will add overtime alarm 23- A scale slow and overtime alarm 24- B scale slow and overtime alarm 25- A balance unloading time alarm 26- Balance B unloading time alarm 27- A balance unloading vibration timeout alarm 28- Balance B unloading vibration timeout alarm</p>
4034	44035	Scale A & Scale B calibration alarm	<p>0. Alarm free 1. The maximum range is too small 2. The maximum range is too large 3. Voltage at zero is too high 4. Zero point voltage too low 5. Mark zero is unstable 6. The gain voltage is too high 7. Gain voltage is too small 8. The scale table is unstable 9. Incorrect weight entry 10. Resolution is too small after calibration (lack of accuracy) 11. Please manually feed and then manually unload (material calibration alarm) 12~15 reserve</p>
4035	44036	Scale A & Scale B control state 3	<p>0- Serial port read-only Enter 1 1- Serial port Read only input 2 2- Serial port Read only input 3 3- Serial port Read only input 4 4- Serial port Read only input 5 5- Serial port controllable switch quantity 1 6- Serial controllable switch quantity 2 7- Serial controllable switch quantity 3 8- Serial controllable switch quantity 4 9- Serial controllable switch quantity 5 10- Done manually 11- Stock level shielding 12-15. Reserve</p>
4036 ~ 8999	Reserve		
Compile information (front and back)			
9000-9001	49001-49002	Background version Number	Example: 010000
90029003	49003-49004	Background compile Date	Example: 161201

9004-9005	49005-49006	Background compile time	Example: 130805
9006-9007	49007-49008	Attach Version number	Example: 100
9008-9011	49009 ~ 49012	Reserve	
The following is bit readable and writable (read function code: 0x01, write function code: 0x05)			
Meter controls function coil switch			
0000	00001	Automatic zero clearing on power-on	Write 1 on, write 0 off. Read as respective on/off status
0001	00002	Secondary filter switch	
0002	00003	Set weight hold switch	
0003	00004	Manual discharge accumulator switch	
0004	00005	Manual discharge judge pinch loose bag switch	
0005	00006	Net gross weight without bucket	
0006	00007	Dynamic filter switch	
0007	00008	AB Target value Set the switch separately	
0008	00009	Over and under detection switch	
0009	00010	Overunderbalance pause switch	
0010	00011	Undergap feed switch	
0011	00012	Drop correction switch	
0012	00013	Code switch	
0013	00014	Allow to add discharge switch when typing	
0014	00015	Conveyor switch	
0015	00016	Print switch	
0016	00017	A Adaptive pause	
0017	00018	B Adaptive pause	
0018	00019	Adaptive parameter update switch	
0019	0020	Reserved	
0020	00021	A Clear zero	Only 1 can be written to this address. Read as 0
0021	00022	A Manual discharge	
0022	00023	A Slow add manually	
0023	00024	A Pinch loose bag	
0024	00025	A Feed manually	
0025	00026	A Add by hand	
0026	00027	A bracket up	
0027	00028	B bracket up	Write 1 on, write 0 off. Read as respective on/off status
0028-0029	Reserve		
0030	00031	B Clear Zero	Only 1 can be written to this address. Read as 0
0031	00032	B Manual discharge	
0032	00033	B Slow add manually	
0033	00034	B Clip loose bag	
0034	00035	B Feed manually	
0035	00036	B Manually Add	
0036-0039	0037-0040	Reserve	
0040	00041	Runs	This address can only be written to 1. Read as 0
0041	00042	Emergency stop	
0042	00043	Stop	
0043	00044	Change Recipes	
0044	00045	Clear Alarm	
0045	00046	Clear current user accumulation	
0046	00047	Clear all user accumulative	
0047	00048	Clear current recipe cumulative	
0048	00049	Clear all recipe accumulated	

0049	00050	Clear total cumulative	
0050	00051	Reset all	
0051	00052	Calibration reset	
0052	00053	Reset of working parameters	
0053	00054	Recipe parameters reset	
0054	00055	Peripheral parameters reset	
0055	00056	Switch quantity reset	
0056	00057	Perform parameter backup	
0057	00058	Restore backup parameters	
0058	00059	Delete backup parameters	This address can only be written to 1 Delete backup parameters. A read of 1 means there are backup parameters, and a read of 0 means there are no backup parameters
0059	00060	Electric parameter reset	This address can only be written to 1. Read as 0
0060	00061	Stitching machine input	
0061	00062	The sewing machine comes to an emergency stop	
0062	00063	Auxiliary Pulse 1	
0063	00064	Auxiliary Pulse 2	
0064	00065	Auxiliary Pulse 3	
0065	00066	Auxiliary Pulse 4	
0066	00067	Auxiliary Logic parameter Reset	
0067	00068	Clear Current Recipe	
0068	00069	Clearing surplus materials	
0069	0070	Clearing surplus materials	
0070	0071	Material level shielding	Write 1 set level shield works, write 0 set level shield does not. Read as material level shield status
0071	0072	Manual Completed	Write 1 to manually complete valid, can not write 0. Read is manually completed
0072-0079	Reserved		
Meter control function coil IO test			
0080	00081	Switch quantity test switch: Enter the switch quantity test when writing 1; Write 0 then exit. Not writable at run time	
0081	00082	Read out 1 when input port 1 is valid. If invalid, will read out 0.	Does not take effect when written.
0082	00083	Read out 0 when input port 2 is valid. If invalid, will read out 0.	
0083	00084	Read out 1 when input port 3 is valid. If invalid, will read out 0.	
0084	00085	Read out 1 when input port 4 is valid. If invalid, will read out 0.	
0085	00086	Read out 1 when input port 5 is valid. If invalid, will read out 0.	
0086	00087	Read out 1 when input port 6 is valid. If invalid, will read out 0.	
0087	00088	Read out 1 when input port 7 is valid. If invalid, will read out 0.	
0088	00089	Read out 1 when input port 8 is valid. If invalid, will read out 0.	
0089	00090	Read out 1 when input port 9 is valid. If invalid, will read out 0.	

0090	00091	Read out 1 when input port 10 is valid. If invalid, will read out 0.	
0091	00092	Read out 1 when input port 11 is valid. If invalid, will read out 0.	
0092	00093	Read out 1 when input port 12 is valid. If invalid, will read out 0.	
0093	00094	When writing 1, output port 1 is valid; When writing 0, output port 1 is not valid.	
0094	00095	Output port 2 is valid when writing 1; When writing 0, output port 2 is not valid.	
0095	00096	Output port 3 is valid when writing 1; When writing 0, output port 3 is not valid.	
0096	00097	Output port 4 is valid when writing 1; When writing 0, output port 4 is not valid.	
0097	00098	Output port 5 is valid when writing 1; When writing 0, output port 5 is not valid.	
0098	00099	Output port 6 is valid when writing 1; When writing 0, output port 6 is not valid.	
0099	00100	When writing 1, output port 7 is valid; When writing 0, output port 7 is not valid.	
0100	00101	When writing 1, output port 8 is valid; When writing 0, output port 8 is not valid.	
0101	00102	When 1 is written, output port 9 is valid. When writing 0, output port 9 is not valid.	
0102	00103	When writing 1, output port 10 is valid; When writing 0, output port 10 is not valid.	
0103	00104	When writing 1, output port 11 is valid; When writing 0, output port 11 is not valid.	
0104	00105	When writing 1, output port 12 is valid; When writing 0, output port 12 is not valid.	
0105	00106	When writing 1, output port 13 is valid; When writing 0, output port 13 is not valid.	
0106	00107	When writing 1, output port 14 is valid; When writing 0, output port 14 is not valid.	
0107	00108	When writing 1, output port 15 is valid; When writing 0, output port 15 is not valid.	
0108	00109	When writing 1, output port 16 is valid; When writing 0, output port 16 is not valid.	
0109	00110	Reserve	
0110	00111	Write 1, serial port controllable switching quantity output 1 output valid. Write 0, serial port controllable switch output 1 output invalid.	
0111	00112	Write 1, serial port controllable switching quantity output 2 output valid. Write 0, serial port controllable switch output 2 output invalid.	
0112	00113	Write 1, serial port controllable switching quantity output 3 output valid. Write 0, serial port controllable switch output 3 output invalid.	
0113	00114	Write 1, serial port controllable switching quantity output 4 output valid. Write 0, serial port controllable switch output 4 output invalid.	
0114	00115	Write 1, serial port controllable switching quantity output 5 output valid. Write 0, serial port controllable switch output 5 output invalid.	

5.4 Re-ContA/B protocol

In this way, there is no need to send any command to the weighing display, and the display automatically sends the collected data to the supremacist.

Return data frame format description:

status	,	Gross/net weight	,	+/-	Weight	Units	CR	LF
2-bytes	2C	47 53/4E 54	2C	2B/2D	7- bytes	g/kg/t/lb	0D	0A

Where:

Status-- **2 bytes**, **OL**(overflow):**4FH 4CH**; **ST**(stable):**53H 54H**; **US**(unstable):**55H 53H**

Gross/Net weight -- **2 bytes**, **GS** (gross) /**NT** (net) : **47 53/4E 54**

Display value - **7 bytes**, including decimal point, high space if no decimal point

Unit -- **2 bytes**, **g**: **20 67**; **kg**: **6B 67**; **t**: **20 74**; **lb**: **6C 62**

To illustrate:

When the weighing display automatically sends the following frame of data:

53 54 2C 47 53 2C 2B 30 31 31 2E 31 32 30 6B 67 0D 0A

You can see that the current status is stable, the data value is positive, and the displayed value is **11.120kg**.

6. Automate the packaging process

GMC-X904D packaging controller can automatically control the whole packaging process of coarse, medium and fine flow, and discharge of all the packaging process. There are bucket scale, no bucket scale, bulk material scale a variety of modes to choose. The structure and working mode of the scale body are set in b3 item of Setup working parameters.

6.1 There are bucket AB double scale packaging methods

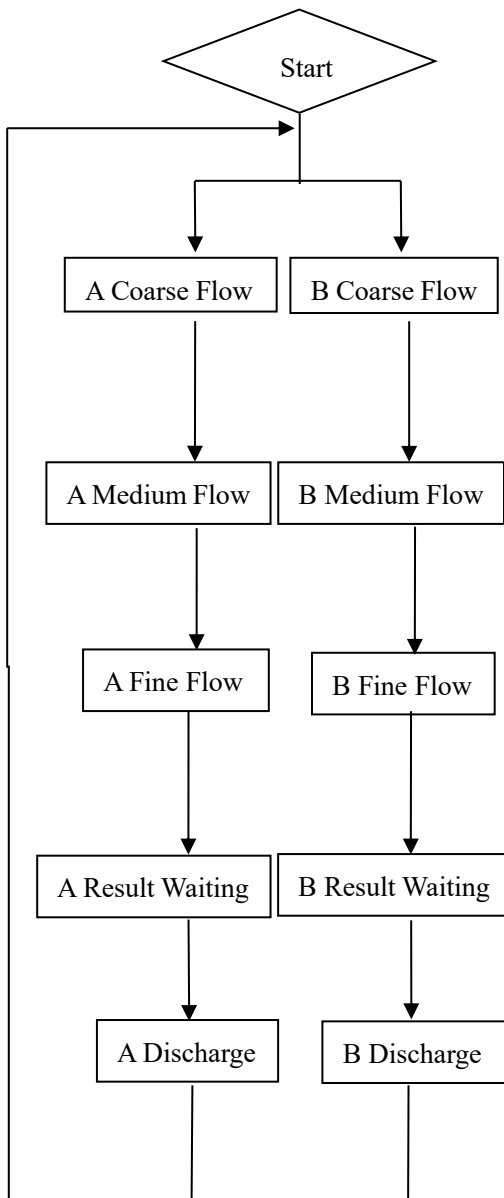

1) Start "Filling Start Delay"; 2) zero operation is determined (Auto Zero Interval)

1) Start "A/B COMP Inhibit Timer (Co-F)", no determination for the weight;

2) Analyzing Weight: The weight of the material \geq single scale target -A / B amount touching scale fast, Co-F closed, Me-F open.

1) Start "A/B COMP Inhibit Timer (Me-F)", no determination for the weight ;

2) Analyzing Weight: The weight of the material \geq single scale target -A / B amount touching scale fast, Me-F closed, Fi-F open.

1) Start "A/B COMP Inhibit Timer (Fi-F)", no determination for the weight ;

2) Analyzing Weight: The weight of the material \geq single scale target -A / B scale Free Fall, Fi-F closed, wait open.

1) Two result checking mode: Stability and delay determination (operating parameter selected), the end of the process according to the selected setting mode, from clutch bag to discharge.

1) Analyzing Weight: Material < Near Zero Band; 2) start "discharge delay." 3) To determine the final balance, then enter a "unlock bag" process or a "Filling Start Delay" under start.

※ In the stopped state, when the external "start" input signal is valid, the meter starts to detect whether the target value and the maximum capacity of the single bucket have been set. If the setting is complete, it will run normally, otherwise it will prompt the "target weight is not reasonable" message and cannot be started.

※ **Target value setting:**

The instrument is compared according to the maximum capacity of a single bucket with the set target value, and the packaging process is carried out according to the comparison result. For details, see the **mode** function description in Chapter 4.1.

※ **Over and under judgment:**

When the "over and under ON/OFF" is opened, in a packaging process, when the last weighing process is completed, the system carries out the over error detection, the weight is stable after the output over and under error alarm signal.

The over and under error suspension switch is "on", if the packaging is over or under error, then

the instrument pauses the automatic quantitative process, the buzzer buzzes, the window displays the alarm information of "A/B over and under error suspension", waiting for the user to process, at this time, the switch quantity can be entered "clear alarm" to effectively clear the alarm signal, the instrument will clear the alarm and continue to run. The user can also enter the emergency stop signal to return to the stop state.

※ **Unlock bags:**

When the instrument is judged as the last weighing, when the time of "discharge delay" is up, close the discharge and start the "release bag start delay" at the same time. After the delay, if the bag is completed, the bag will be loosened. If the bag is not completed, the bag will be loosened until the bag is completed.

During operation, if the stop input is valid, the instrument will return to the stop state after the completion of this combination weighing.

※ **Discharge times**

If the target value is an integer multiple of the maximum capacity of a single bucket, then "automatically calculated discharge times" is the target value/maximum capacity of a single bucket. Otherwise, the "automatically calculated number of discharge" is the target value/the maximum capacity of a single bucket +1, and the **single weigher target value** is the target value/the automatically calculated number of discharge. After starting, the target value of **A** and **B** can be seen at the bottom of the main interface, and then the scale of **A** and **B** can be discharged in parallel, who first arrives at the quantity who first discharges. A total

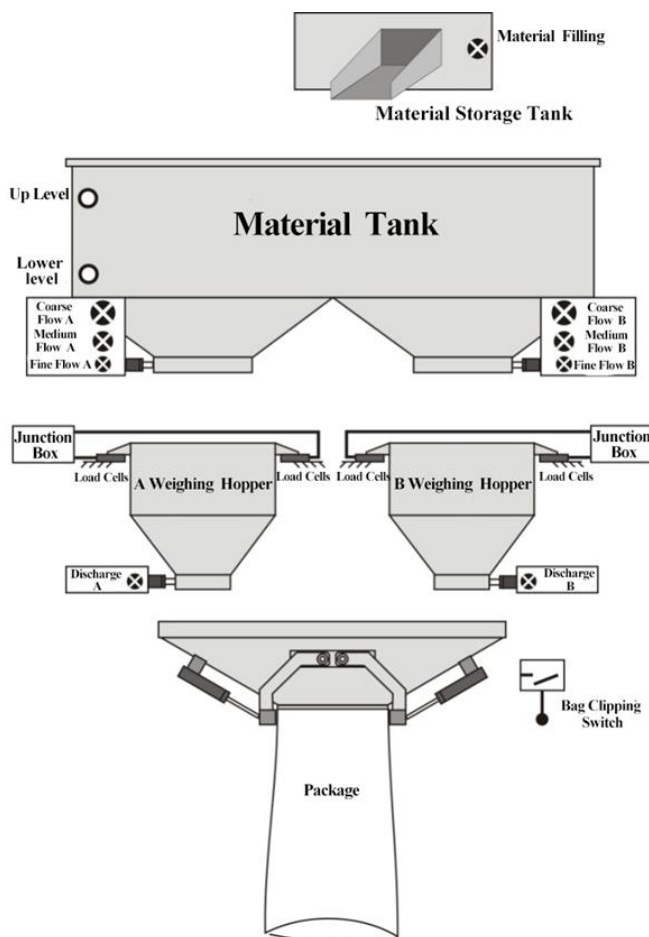

of discharge "automatically calculated discharge times" to loose the bag once.

If the single weigher target value is the target value. At this time **A**, **B** balance alternate discharge, discharge once loose bag once.

AB separately set the target value mode, according to their respective set of **A** target value or **B** target value to complete their quantitative process, the unloading process of the two scales is separate, that is, when **A** scale is unloading, **B** scale even if the completion of loading also need to wait for **A** scale to complete unloading, and bag again before unloading.

6.2 Separate A scale, B scale packaging method

Under the structure of the scale body with or without A bucket or bulk material structure, the working mode is selected as **A separate A** scale (or separate **B** scale), which is suitable for the situation that only one scale can work due to mechanical failure or other reasons, and there is a scale to complete the packaging process, specifically refer to the **process** of **A** scale or **B** scale in Chapter 6.1.

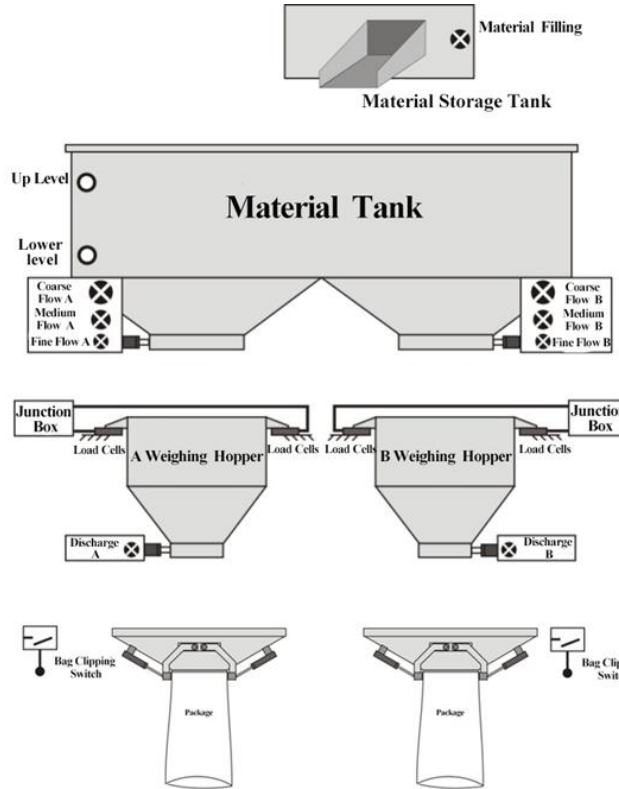

6.3 Double bucket double bag AB independent packaging method

The structure of the scale body is to be packed with bucket, and the working mode is to be double bucket double bag **AB** independent.

The structure of the scale body is shown in the figure on the right, using two measuring buckets, two clamping bag mechanisms, **AB** scale work alone (in addition to conveyor work, other work does not affect each other)

The packing process is the same as the single bag mode. See Section 6.1.

6.4 Double bucket double clip bag AB combination packing method

The difference between the double bucket double bag **AB** combination mode and the double bucket double bag **AB** independent packaging mode lies in the control logic of the conveyor.

After starting, **B** scale began to feed, **A** scale also began to feed, and wait for **A** and **B** are loose bags (independent way does not need to wait for bucket loose bag), the instrument control conveyor starts, the feeding completed bag transport away, and then you can start the next process after bag clamping.

Note: Double bucket packaging uses two metering buckets, two clip bag mechanisms, **AB** scales work independently (in addition to conveyor work, other work does not affect each other)

6.5 No bucket double scale combination packaging method

In the bucket-free mode, the material is fed directly from the hopper to the bag through

the charging mechanism (fast, medium and slow), and the weight sampling of the meter measurement control process is completed in the bag (the weighing sensor is installed on the hopper). After the measurement is completed, the instrument control directly loosens the bag. The difference between the bucket-less packaging process and the bucket-packed process is that the sensor is installed on the hopper, and after starting, it needs to complete the bag clamping action before starting the feeding delay to start the feeding process.

The structure of the scale body selects bucket-less packaging, and the working mode is selected as bucket-less **AB** combination. **1)** If the **AB** target value is set as off separately, the target value is the target value of each scale **A** and **B**; **2)** If the target value of **AB** is set to open separately, the target value of **A** and **B** will be the target value of each scale **A** and **B** respectively. All have nothing to do with the maximum capacity of a single bucket, but cannot exceed the maximum measuring range.

After the start, **B** scale bag began to feed, **A** scale bag also began to feed, and wait for **A** and **B** are loose bag, instrument control conveyor start, the feeding completed bag transport, and then you can start the next process after the bag, if **A** scale bag filling is completed and loose bag, **B** scale has not pinch bag, instrument control conveyor start; If **A** scale is not bagged, **B** scale bag loading completed and bagged, instrument control conveyor start.

6.6 No bucket double scale independent packaging method

The structure of the scale body is selected as bucket-free packaging, and the working mode is selected as bucket-free **AB** independent. **1)** If the **AB** target value is set as off separately, the target value is the target value of each scale **A** and **B**; **2)** If the target value of **AB** is set to open separately, the target value of **A** and **B** will be the target value of each scale **A** and **B** respectively. All have nothing to do with the maximum capacity of a single bucket, but cannot exceed the maximum measuring range.

After starting, after any scale is fed and loosened, the instrument will start the conveyor to start conveying.

Its structure is shown in the following figure:

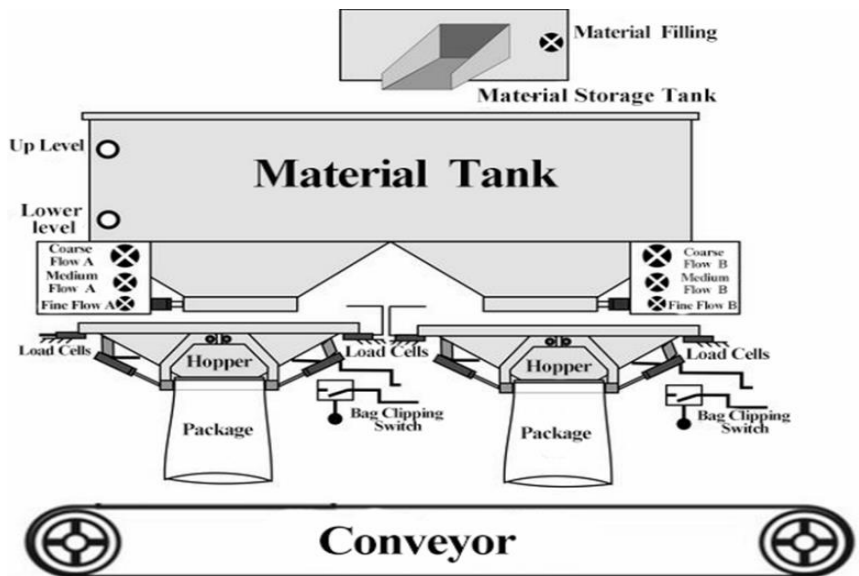

6.7 Packing method of bulk materials

1) Bulk material **AB** interlock mode: In the running state, the weighing unit **A** is first started to feed the weighing tank (large, medium and small), and the weight sampling of the meter measurement control process is completed in the weighing tank (the weighing sensor

is installed on the weighing tank). After the measurement is completed, the material is discharged through the unloading mechanism under the weighing tank, and the weight value is accumulated. When the **A** weighing unit is unloaded, the **B** weighing unit begins feeding and the weighing process is carried out. The loading/unloading of weighing cells **A** and **B** are interlocked.

2) Bulk material **AB** independent mode: **AB** scale can be loaded and unloaded at the same time, no longer interlock.

3) Bulk material separate **A** mode: only **A** scale is working

4) Bulk material alone Mode **B**: Only scale **B** is working

Process description:

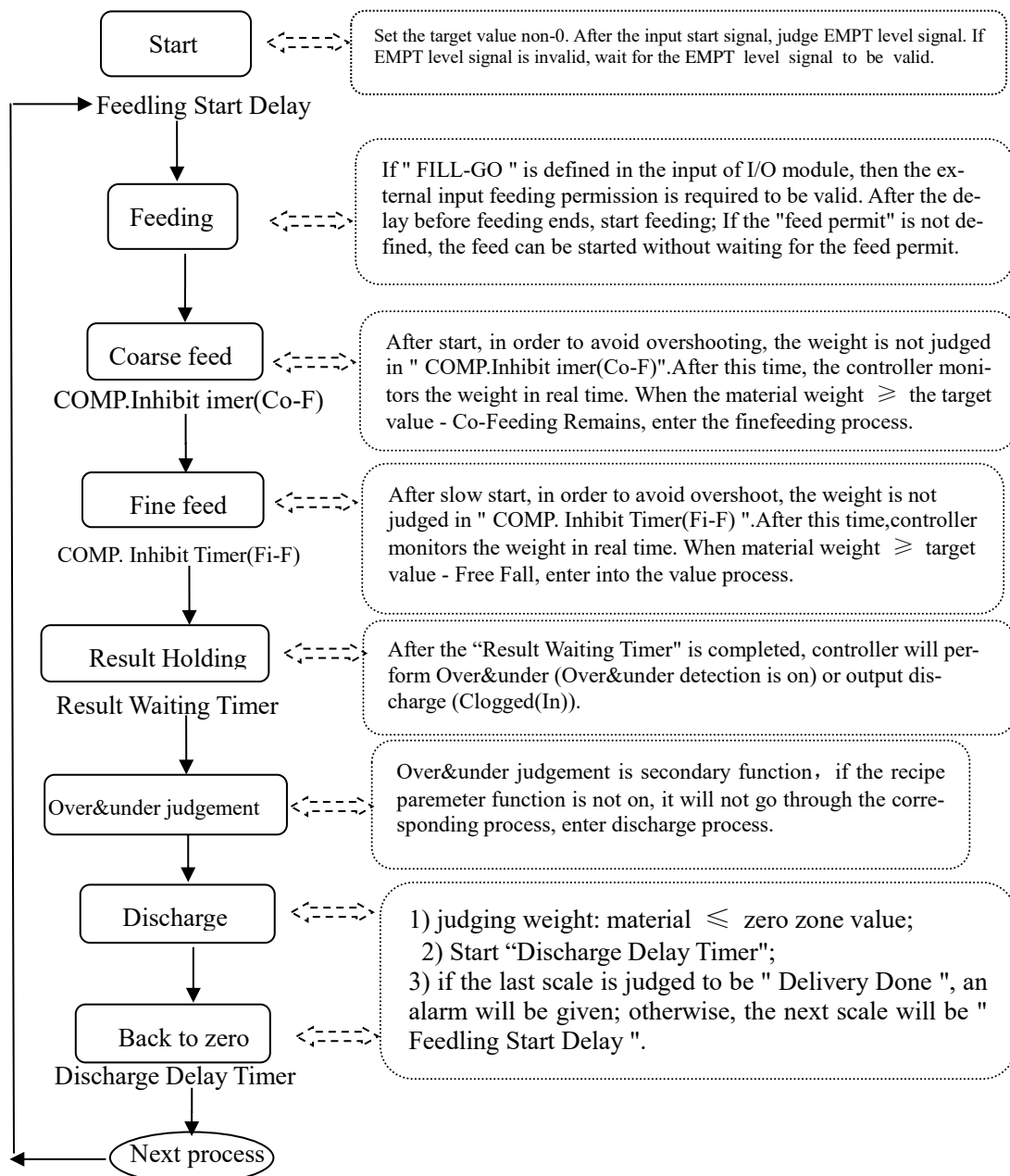

7. Motor working process

7.1 Motor feeding part

7.1.1 Stepper motor feeding

Stepper motor control feeding door switch: the switch quantity involved is: **O31**(Scale A filling pulse output)/**O32** (Scale A filling direction)/ **O33**(Scale B filling pulse output)/**O34** Scale B filling direction), **I31**(Scale A fill gate closed ready)/**I32** (Scale B fill gate closed ready). (**I31/I32 signal is determined by the type of in place signal**).

Take the feeding process of A scale as an example:

- Coarse flow process: Instrument control **O32**(Scale A filling direction) output to ensure that the motor rotation direction is the direction of opening the door, and then **O31**(Scale A filling pulse output) output pulse according to the set scale A feeding motor frequency to control the feeding stepper motor to rotate in the direction of opening the door, **O31**(Scale A filling pulse output) number reaches the set value to stop the output pulse signal, the feeding door to stop rotating, At this time, it is a large investment state. The meter then changes the **O32** (Scale A filling direction) output to the closing direction.

- Medium flow process: **O31**(Scale A filling pulse output) outputs pulses according to the set frequency of the charging motor of A scale, controls the charging stepper motor to rotate in the direction of closing the door, stops the output pulse signal after the number of **O31**(Scale A filling pulse output) reaches the set value, and the charging door stops rotating. At this time, it is the CIC state.

- Fine flow process: **O31**(Scale A filling pulse output) output pulses according to the set A scale feeding motor frequency, control the feeding stepper motor to continue to rotate in the direction of the door, **O31**(Scale A filling pulse output) number reaches the set value after the output pulse signal stops, the feeding door stops rotating, at this time for the small feeding state.

- Filling closing: **O31**(Scale A filling pulse output t) according to the set A balance charging motor frequency to output the pulse, control the charging stepper motor continue to rotate in the direction of closing the door, until **I31**(Scale A fill gate closed ready) input effective stop output pulse signal, the charging door stop rotating, at this time the charging completely closed. Note: If the closing process time exceeds the charging door closing timeout time set by the charging door closing timeout time, the instrument has not detected **I31**(Scale A fill gate closed ready), then the instrument will stop **O31**(Scale A filling pulse output), and alarm scale A charging door closing timeout.

7.1.2 General motor feeding

Ordinary motor control charging door switch: the switching quantity involved is: A scale **O43**(Scale A filling gate open)/**O45**(Scale A filling gate closed), **I31**(Scale A fill gate closed ready), B scale **O44**(Scale B filling gate open)/**O46** (Scale B filling gate closed), **I32**(Scale B fill gate closed ready).

Take the feeding process of large and small scale A as an example:

- Coarse flow process: A scale delay **t1** time after the start of the feeding process. Instrument first makes A scale **O43**(Scale A filling gate open) signal output effective, effective time for A scale quickly add the opening time, start the rapid feeding process.

- Medium flow process: When **the** weight of the material in the hopper of A scale **is** greater than the target value of A scale, A scale **O45**(Scale A filling gate closed) signal output is effective, and the effective time is "A scale fast opening time -A scale open the door time".

- Fine flow process: when the weight of the material in the hopper of A scale is greater than or equal to the target value of A scale - when the advance of A scale, the signal

output of A scale **O45**(Scale A filling gate closed) is effective, and the effective time is "A scale adding the opening time -A scale slowly adding the opening time".

- Filling closing: when **the** weight of the material in the hopper of A scale is greater than or equal to the target value **of A** scale -A scale small feed lead, **the O45**(Scale A filling gate closed) signal output of A scale is effective until it detects the feed door of A scale in place signal **I31**(**A feed door closed in place**).

Note: If the closing process time exceeds the **charging door closing timeout time**, the instrument has not detected **I31**(Scale A filling pulse output), then the instrument will stop **O45**(Scale A filling gate closed), and alarm A scale charging door timeout. Note: When the meter is started, it is necessary to detect whether the charging door and discharge door are in the limit. If they are not in the limit, the alarm will be raised and they cannot be started.

7.2 Motor clip bag part

7.2.1 Stepper motor clip loose bag

Stepper motor control clip bag: the switch quantity involved is: **O35**(Scale A bag lock/unlock pulse output)/**O36** (Scale A bag lock/unlock direction signal)/ **O37**(Scale B bag lock/unlock pulse output)/ **O38** (Scale B bag lock/unlock direction signal), **I33** (Scale A bag unlocked ready)/ **I34** (Scale B bag unlocked ready). (The **I37/I38** signal is determined by the type of the in place signal).

Take **binyes** with metering bucket mode pinch loose bag process as an example:

- Bag clamping process: The instrument controls the output of **O36** (A balance bag direction signal) to ensure that the motor rotation direction is the bag direction, and then **O35**(**A bag pulse**) outputs the pulse according to the set A bag motor frequency, and controls the bag stepper motor to rotate in the bag direction. **O35**(Scale A bag lock/unlock pulse output) number reaches the set scale A pinch bag required pulse number to stop the output pulse signal, at this time the bag mechanism is in the pinch bag state. Then the instrument changes the output of **O36** (A scale pocket direction signal) to the direction of loosening the bag.

- Bag loosening process: **O35**(Scale A bag lock/unlock pulse output) outputs the pulse according to the set A balance bag loosening motor frequency, controls the bag loosening stepper motor to rotate in the direction of bag loosening until the input of **I33** (A bag loosening in place) is detected to be effective and stops the output pulse signal, at this time, the bag loosening state. Note: If the bag loosening process time exceeds the set bag loosening process timeout time, the instrument has not detected **I33** (Scale A bag unlocked ready), then the instrument will stop output **O35**(Scale A bag lock/unlock pulse output), and alarm A scale bag loosening timeout.

7.2.2 Motor double limit pinch pouch release

Ordinary motor double limit control clip bag: the switch quantity involved is: **O9**(Scale A bag locked)/**O47**(Scale A bag unlock)/**O12**(Scale B bag locked)/**O48**(Scale B bag unlock), **I23**(Bag Locked in place)/**I33**(Scale A bag unlocked ready)/**I24**(Scale B bag locked in place)/ **I34**(Scale B bag unlocked ready). (The **I33/I34** signal is determined by the type of loose bag in place signal).

Take the process of adding pinch loose bag in metering bucket mode as an example:

- Bag clamping process: the instrument output bag clamping signal **O9**(Scale A bag locked) controls the bag clamping motor to rotate in the direction of bag clamping, until the bag in place signal **I23**(**A bag in place**) is detected and the output bag signal **O9**(Scale A bag locked) is stopped after the input is effective, and the bag clamping mechanism is in the bag clamping state. Note: If the bag clamping process time exceeds the set bag clamping process timeout time, the instrument has not detected the bag clamping signal **I23**(Bag

Locked in place), then the instrument will stop the output bag clamping signal **O9**(Scale A bag locked)), and alarm scale A bag clamping process timeout.

- Loose bag process: instrument output loose bag signal **/O47**(Scale A bag unlock) control bag motor to loose bag direction rotation, until detected loose bag signal **I33**(A Scale A bag unlocked ready) input effective stop output loose bag signal **/O47**(Scale A bag unlock), at this time the bag clamping mechanism is in the loose bag state. Note: If the loosening bag process time exceeds the set loosening bag process timeout time, the instrument has not detected the loosening bag in place signal **I33**(Scale A bag unlocked ready), then the instrument will stop output loosening bag signal **/O47**(Scale A bag unlock), and alarm scale A loosening bag process timeout.

7.2.3 Motor single limit pinch pouch release

Ordinary motor double output control control clip bag: the switch quantity involved is: **O9**(Scale A bag locked)/**O47**(Scale A bag unlock)/**O12**(Scale B bag locked)/**O48**(Scale B bag unlock), **I23**(Bag Locked in place)/ **I24**(Scale B bag locked ready)

Take **binyes** with a metering bucket mode under the clamping bag loosening process as an example:

- Bag clamping process: instrument control **O9**(Scale A bag locked) switching output signal, output signal until detected bag in place signal **I23**(A bag in place) input is effective, the output signal output is invalid, to achieve equipment bag clamping.

- Loose bag process: instrument control **/O47**(Scale A bag unlock) switching quantity output signal, to achieve equipment loose bag, output signal duration for loose bag output, the output signal output is invalid. **Note:** If the bag clamping process time exceeds the set bag clamping process timeout time, the instrument has not detected the bag clamping signal **I23**(Bag Locked in place), then the instrument will stop output **O9**(Scale A bag locked), and alarm scale A bag clamping process timeout.

7.3 Motor discharge section

7.3.1 Stepping motor discharging

Stepper motor control unloading: The amount of switches involved are: **I25**(Scale A discharge gate closed ready)/ **O39**(Scale A discharge pulse output)/ **O40**(A Scale A discharge direction signal)

Take the unloading of **A** scale as an example:

- Unloading door opening process: Instrument control **O40**(Scale A discharge direction signal) output, ensure that the motor rotation direction is the direction of opening the door, and then **O39**(Scale A discharge pulse output) according to the set discharge door motor frequency to output pulse, control the discharge stepper motor rotation to the discharge door direction, The number of **O39**(A balance unloading pulse) reaches the value set by the number of pulse required by A balance unloading to stop the output pulse signal, at this time the unloading mechanism is in the open state

- Unloading and closing process: After the discharge door is opened, the instrument detects the weight in the hopper if it is lower than near zero, then the discharge delay time is started. After the discharge delay time is over, the instrument changes the output of **O40**(discharge direction signal of A scale) to the closing direction, and **O39**(Scale A discharge pulse output) outputs the pulse according to the set discharge closing motor frequency to control the discharge stepper motor to rotate in the closing direction. Until the detection of **I25**(Scale A discharge gate closed ready) input effective to stop the output pulse signal, at this time for the closed state. Note: If the closing process time exceeds the set unloading closing timeout time, the instrument has not detected the closing position signal **I25**(Scale A discharge gate closed ready), then the instrument will stop output **O39**(Scale A discharge pulse output), and alarm **A** scale unloading and closing timeout.

7.3.2 Single limit discharge of motor

General motor positive and negative single limit mode control discharge: the amount of switches involved are: **O11**(Scale A discharge)/**O14**(Scale B discharge)/**O49**(Scale A discharge gate closed)/**O50**(Scale B discharge gate closed), **I25**(A Scale A discharge gate closed ready)/**I26**(Scale B discharge gate closed).

Take the unloading process of A scale as an example:

- Unloading door opening process: At the beginning of the unloading process, the instrument outputs the unloading signal **O11**(Scale A discharge) to control the unloading motor to rotate in the direction of the unloading door, and continues the unloading motor door opening signal output time set by the effective time of the unloading door output, and then closes the unloading signal **O11**(Scale A discharge) output.

- The process of unloading the door: After the unloading door is opened, the instrument detects if the weight in the hopper is lower than near zero, then start the unloading delay time, after the unloading delay time is over, output the unloading close signal **O49**(Scale A discharge gate closed), and control the unloading motor to rotate in the unloading close direction. Until it is detected that the discharge door is closed in place signal **I25**(A discharge door is closed in place) is input and effective, stop the output discharge door signal **O49**(Scale A discharge gate closed), at this time the discharge door is closed. Note: If the closing process time of the unloading door exceeds the set unloading and closing timeout time of A scale, the instrument does not detect the unloading door closing in place signal **I25**(A Scale A discharge gate closed ready), then the instrument will stop output **O49**(Scale A discharge gate closed), and alarm A scale unloading and closing timeout.

7.3.3 Motor double limit discharge

Ordinary motor positive and negative rotation double limit mode control discharge: the amount of switches involved are: **O11**(Scale A discharge)/**O14**(Scale B discharge)/**O49**(Scale A discharge gate closed)/**O50**(Scale B discharge gate closed), **I25**(A Scale A discharge gate closed ready)/ **I35**(Scale A discharge gate opened ready)/**I26**(Scale B discharge gate closed)/ **I36**(Scale B discharge gate opened ready).

Take the unloading process of scale A as an example:

- Unloading door opening process: At the beginning of the unloading process, the instrument outputs the unloading signal **O11**(Scale A discharge) to control the unloading motor to rotate in the direction of the unloading door, until it detects that the unloading door is in place signal **I35**(Scale A discharge gate opened ready) and stops the output unloading signal **O11**(Scale A discharge) after the input is effective. At this time, the unloading door is open. Note: If the unloading door opening process time exceeds the set scale A unloading door opening timeout time, the instrument has not detected the unloading door opening in place signal **I35**(Scale A discharge gate opened ready), then the instrument will stop output **O11**(Scale A discharge), and alarm A unloading door opening timeout.

- The process of unloading and closing: After the unloading door is opened, the instrument detects if the weight in the hopper is lower than near zero, then start the unloading delay time. After the unloading delay time is over, output the unloading close signal **O11**(Scale A discharge), and control the unloading motor to rotate in the direction of the unloading close door. Until it is detected that the discharge door is closed in place signal **I25**(A Scale A discharge gate closed ready) is input and effective, stop the output discharge door signal **O11**(Scale A discharge), at this time the discharge door is closed. Note: If the closing process time of the discharge door exceeds the set A discharge door closing timeout time, the instrument does not detect the discharge door closing in place signal **I25**(A Scale A discharge gate closed ready), then the instrument will stop output **O11**(Scale A discharge), and alarm A discharge door closing timeout.

7.3.4 Unidirectional rotation of the motor for one week unloading

Ordinary motor one-way rotation one week single limit way to control discharge: the amount of switches involved are: **O11**(Scale A discharge)/**O14**(Scale B discharge), **I25**(A Scale A discharge gate closed ready)/ **I26**(Scale B discharge gate closed).

Take the unloading process of **A** scale as an example:

- Unloading door opening process: At the beginning of the unloading process, the instrument outputs the unloading signal **O11**(Scale A discharge) to control the unloading motor to rotate in the direction of the unloading door, and continues to set the unloading motor door opening signal output time, and then close the unloading signal **O11**(Scale A discharge) output.

- Unloading and closing process: After the unloading door is opened, the instrument detects if the weight in the hopper is lower than near zero, then start the unloading delay time, after the unloading delay time is over, output the unloading signal **O11**(Scale A discharge), and control the unloading motor to continue to rotate in the direction of the unloading door. Until it is detected that the discharge door is closed in place signal **I25**(A Scale A discharge gate closed ready) is input and effective, stop the output discharge signal **O11**(Scale A discharge), at this time the discharge door is closed. Note: If the closing process time of the unloading door exceeds the unloading closing timeout time, the instrument does not detect the unloading door closing in place signal **I25**(A Scale A discharge gate closed ready), then the instrument will stop output **O11**(Scale A discharge), and alarm scale A unloading door timeout.

8. Instrument size (mm)

